

Haier

MRV 5-H Service Manual



SYJS-2021.A

Edition: 2021-01

CONTENTS

1. Safety considerations	1
1.1 Caution in repair	1
1.2 Cautions regarding products after repair	4
1.3 Inspection after repair	6
2. General information	7
2.1 Feature	7
2.2 Products lineup	9
3. Specification	16
4. Dimension	91
5. Center of gravity	93
6. Piping diagram	95
7. Refrigerant flow	98
8. Functional parts layout	100
9. Wiring diagram	103
10. Capacity calculation due to capacity modification coefficient	106
11. Selection procedure	112
12. Operation range	113
13. Noise level	114
14. Installation	116
14.1 Safety	116
14.2 Installation instruction	118
14.3 Installation procedure	128
14.4 Electric wiring and the application	138
15. Branch pipe dimension	143
16. Gather pipe dimension	145
17. Trial operation	146
17.1 Confirmation by electrifying	146
17.2 Rated operation	146
17.3 Trial operation confirmation	147
18. Startup	155
18.1 Startup procedure	155
18.2 Installation checking	155
18.3 Wiring-dip switch	157
18.4 Power on	158
18.5 Search and lock outdoor \ indoor unit	158
18.6 Trial operation and parameters record	158
18.7 MRV 5 system startup report	159
19. Outdoor control board photo	164
20. Outdoor PCB dip switch setting	169
21. Outdoor system control function	179
21.1 Compressor control	179
21.2 Electronic expansion valve control	179
21.3 Fan motor control	179
21.4 Start Control	180

21.5 Oil return control	183
21.6 Defrosting control	183
21.7 Pump down operation	184
21.8 High pressure protection	184
21.9 Low pressure protection	185
21.10 The temperature of discharge too high control.....	185
21.15 Target pressure control.....	187
21.16 Overheating protection control	187
21.17 Current protection control.....	188
21.18 Heating is prohibited.....	188
22. Failure code	189
23. Troubleshooting	195
23.1 Flow chart.....	195
23.2 Lack of refrigerant judgment method.....	244
23.3 The checking method for the valve	245
23.4 The 4-way valve reversing condition	245
23.5 Fan motor detection standard	246
23.6 Power module detection standard.....	248
23.7 Compressor detection standard	249
23.8 Sensor resistance table	250
24. Parts Replacement Instructions	259
24.1 Compressor replacement	259
25. Smartlink	262
25.1 Smartlink Introduction.....	262
25.2 Smartlink benefits.....	264
25.3 Smartlink specification.....	265
25.4 Wiring figure	265
25.5 Dimension	266
25.6 The installation requirement of Smartlink	267
25.7 The debugging guidance of Smartlink.....	268
26. Central control & BMS system for MRV5-H	271
26.1 Central control system.....	271
26.2 BMS system	273
26.3 Dip switch setting for address	276

1. Safety considerations

Cautions and warnings





Read these SAFETY CONSIDERATIONS carefully before installing air conditioning equipment, and be sure to install it correctly. After completing the installation, make sure that the unit operates properly during the start-up operation.

Instruct the customer how to operate and maintain the unit.

Inform customers that they should store this Installation Manual with the Operation Manual for future reference.

Always use a licensed installer or contractor to install this product. Improper installation can result in water or refrigerant leakage, electrical shock, fire, or explosion.

Meanings of DANGER, WARNING, CAUTION, and NOTE Symbols:

-  **DANGER** Indicates an imminently hazardous situation which, if not avoided, will result in death or serious injury.
-  **WARNING** Indicates a potentially hazardous situation which, if not avoided, could result in death or serious injury.
-  **CAUTION** Indicates a potentially hazardous situation, if not avoided, may result in minor or moderate injury. It may also be used to alert against unsafe practices.
-  **NOTE** Indicates situations that may result in equipment or property-damage accidents only. Be sure to read the following safety cautions before conducting repair work.

1.1 Caution in repair

 Warning	
<p>Be sure to disconnect the power cable plug from the plug socket before disassembling the equipment for a repair.</p> <p>Working on the equipment that is connected to a power supply can cause an electrical shock.</p> <p>If it is necessary to supply power to the equipment to conduct the repair or inspecting the circuits, do not touch any electrically charged sections of the equipment.</p>	
<p>If the refrigerant gas discharges during the repair work, do not touch the discharging refrigerant gas.</p> <p>The refrigerant gas can cause frostbite.</p>	
<p>When disconnecting the suction or discharge pipe of the compressor at the welded section, release the refrigerant gas completely at a well-ventilated place first.</p> <p>If there is a gas remaining inside the compressor, the refrigerant gas or refrigerating machine oil discharges when the pipe is disconnected, and it can cause injury.</p>	





 Warning

If the refrigerant gas leaks during the repair work, ventilate the area. The refrigerant gas can generate toxic gases when it contacts flames.

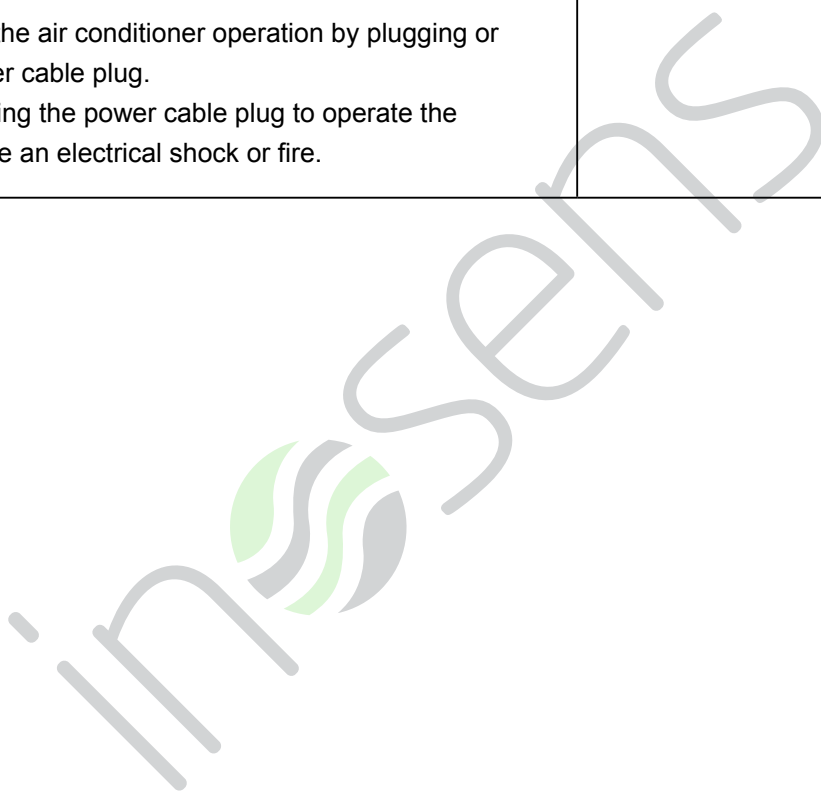
The step-up capacitor supplies high-voltage electricity to the electrical components of the outdoor unit.
Be sure to discharge the capacitor completely before conducting repair work. A charged capacitor can cause an electrical shock.

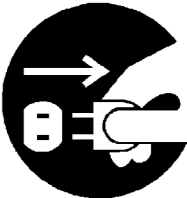

Do not start or stop the air conditioner operation by plugging or unplugging the power cable plug.
Plugging or unplugging the power cable plug to operate the equipment can cause an electrical shock or fire.





 Caution	
<p>Do not repair the electrical components with wet hands. Working on the equipment with wet hands can cause an electrical shock.</p>	
<p>Do not clean the air conditioner by splashing water. Washing the unit with water can cause an electrical shock.</p>	
<p>Be sure to provide the grounding when repairing the equipment in a humid or wet place, to avoid electrical shocks.</p>	
<p>Be sure to turn off the power switch and unplug the power cable when cleaning the equipment. The internal fan rotates at a high speed, and can cause injury.</p>	
<p>Do not tilt the unit when removing it. The water inside the unit can spill and wet the furniture and floor.</p>	
<p>Be sure to check that the refrigerating cycle section has cooled down sufficiently before conducting repair work. Working on the unit when the refrigerating cycle section is hot can cause burns.</p>	
<p>Use the welder in a well-ventilated place. Using the welder in an enclosed room can cause oxygen deficiency.</p>	

1.2 Cautions regarding products after repair



 Warning	
<p>Be sure to use parts listed in the service parts list of the applicable model and appropriate tools to conduct repair work. Never attempt to modify the equipment. The use of inappropriate parts or tools can cause an electrical shock, excessive heat generation or fire.</p>	
<p>When relocating the equipment, make sure that the new installation site has sufficient strength to withstand the weight of the equipment. If the installation site does not have sufficient strength and if the installation work is not conducted securely, the equipment can fall and cause injury.</p>	
<p>Be sure to use an exclusive power circuit for the equipment, and follow the technical standards related to the electrical equipment, the internal wiring regulations and the instruction manual for installation when conducting electrical work. Insufficient power circuit capacity and improper electrical work can cause an electrical shock or fire.</p>	
<p>Be sure to use the specified cable to connect between the indoor and outdoor units. Make the connections securely and route the cable properly so that there is no force pulling the cable at the connection terminals. Improper connections can cause excessive heat generation or fire.</p>	
<p>When connecting the cable between the indoor and outdoor units, make sure that the terminal cover does not lift off or dismount because of the cable. If the cover is not mounted properly, the terminal connection section can cause an electrical shock, excessive heat generation or fire.</p>	
<p>Do not damage or modify the power cable. Damaged or modified power cable can cause an electrical shock or fire. Placing heavy items on the power cable, and heating or pulling the power cable can damage the cable.</p>	

 Warning	
<p>Do not mix air or gas other than the specified refrigerant (R-410A) in the refrigerant system.</p> <p>If air enters the refrigerating system, an excessively high pressure results, causing equipment damage and injury.</p>	
<p>If the refrigerant gas leaks, be sure to locate the leak and repair it before charging the refrigerant. After charging refrigerant, make sure that there is no refrigerant leak.</p> <p>If the leak cannot be located and the repair work must be stopped, be sure to perform pump-down and close the service valve, to prevent the refrigerant gas from leaking into the room. The refrigerant gas itself is harmless, but it can generate toxic gases when it contacts flames, such as fan and other heaters, stoves and ranges.</p>	
<p>When replacing the coin battery in the remote controller, be sure to dispose of the old battery to prevent children from swallowing it.</p> <p>If a child swallows the coin battery, see a doctor immediately.</p>	

 Caution	
<p>Installation of a leakage breaker is necessary in some cases depending on the conditions of the installation site, to prevent electrical shocks.</p>	
<p>Do not install the equipment in a place where there is a possibility of combustible gas leaks.</p> <p>If a combustible gas leaks and remains around the unit, it can cause a fire.</p>	
<p>Be sure to install the packing and seal on the installation frame properly.</p> <p>If the packing and seal are not installed properly, water can enter the room and wet the furniture and floor.</p>	For integral units only

1.3 Inspection after repair

 Warning	
<p>Check to make sure that the power cable plug is not dirty or loose, then insert the plug into a power outlet all the way. If the plug has dust or loose connection, it can cause an electrical shock or fire.</p>	
<p>If the power cable and lead wires have scratches or have deteriorated, be sure to replace them. Damaged cable and wires can cause an electrical shock, excessive heat generation or fire.</p>	
<p>Do not use a joined power cable or extension cable, or share the same power outlet with other electrical appliances, since it can cause an electrical shock, excessive heat generation or fire.</p>	

 Caution	
<p>Check to see if the parts and wires are mounted and connected properly, and if the connections at the soldered or crimped terminals are secure. Improper installation and connections can cause excessive heat generation, fire or an electrical shock.</p>	
<p>If the installation platform or frame has corroded, replace it. Corroded installation platform or frame can cause the unit to fall, resulting in injury.</p>	
<p>Check the grounding, and repair it if the equipment is not properly grounded. Improper grounding can cause an electrical shock.</p>	
<p>Be sure to measure the insulation resistance after the repair, and make sure that the resistance is 1 ohm or higher. Faulty insulation can cause an electrical shock.</p>	
<p>Be sure to check the drainage of the indoor unit after the repair. Faulty drainage can cause the water to enter the room and wet the furniture and floor.</p>	

2. General information

2.1 Feature

. ENERGY SAVING

Compared with normal compressor, the capacity of compressor is increased by 27%, COP is increased by 19%, the whole unit capacity is increased by 25% in -20°C .

The compressor is built-in one-way valve, and COP performance can be improved by 5% under low frequency operation

Full DC inverter technology. Quick start, fast cooling and heating; soft start, low start current, little impact on power grid; when the room temperature is reached, the compressor automatically turns to low speed operation with low power consumption

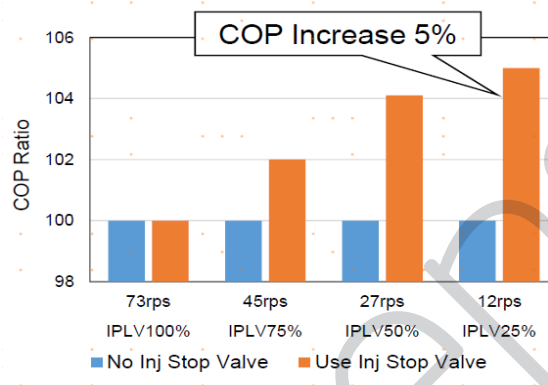

2 Stage Sub-cooling Technology

- Outdoor unit two-stage sub-cooling design, the degree of sub-cooling up to 20°C , greatly improve the cooling and heating capacity, reduce the system refrigerant pressure loss, improve the system capacity.
- At the same time, adding sub-cooling heat exchanger in the system can also improve the long piping capacity.

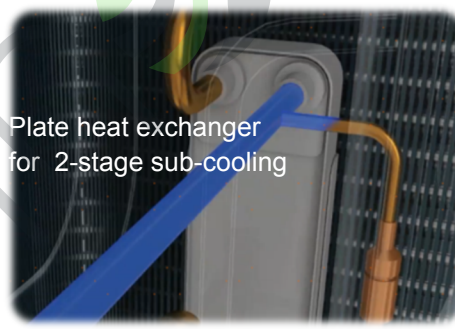

Oil return in heating condition, the EEV don't change direction

Heating return oil, indoor units can normal heat, room temperature keep stable, improve indoor temperature comfort.

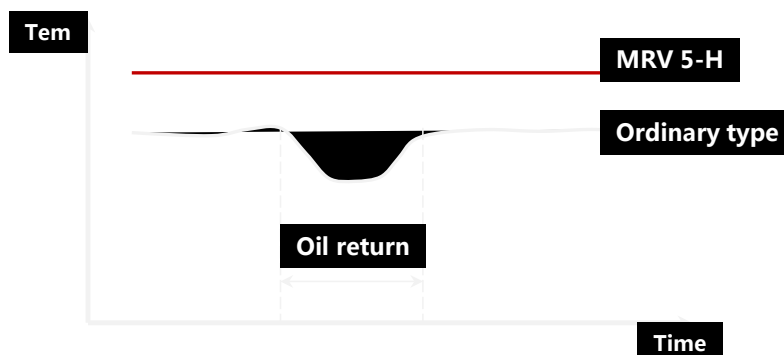

Door type electric control box design

Rotating electric control box, can be opened to the side, compressor, tank and valve body maintenance is convenient



Enhanced Vapor Injection technology, low temperature heating and high temperature cooling.

The unit adopts EVI compressor, which can increase the refrigerant circulation by 15%, and improve the heating effect by 30% compared with the normal type. Meanwhile, the one-way valve built in, and the efficiency of the unit can be increased by 5%. The heating temperature in winter can be -27°C , and the heating temperature in summer can be 52°C .

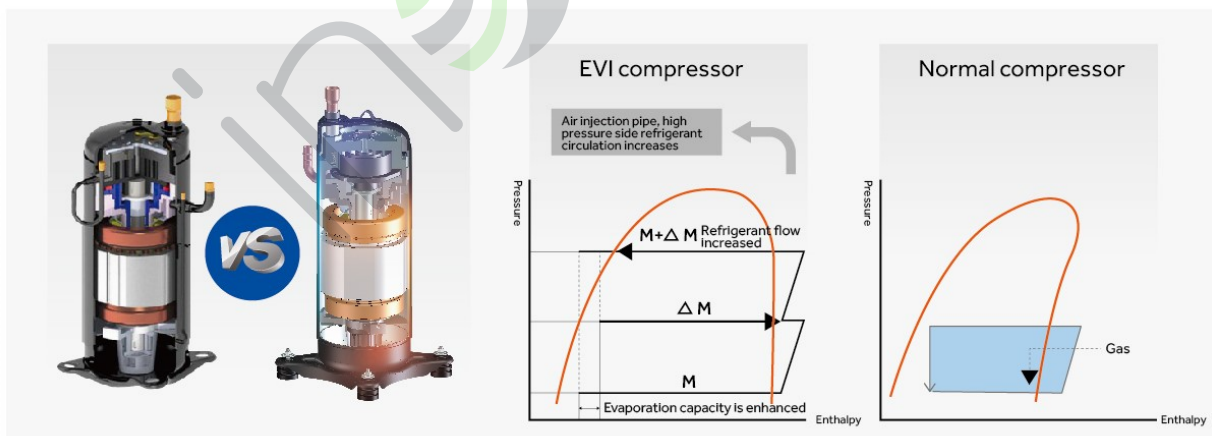

2.2 Products lineup

Indoor units

<p>4-WAY CASSETTE TYPE/PB-700IB</p> <p>AB052MCERA AB072MCERA AB092MCERA AB122MCERA AB162MCERA AB182MCERA(C)</p> 	<p>ROUND-WAY SMART AIR FLOW CASSETTE/ PB-950KB</p> <p>AB072MRERA AB092MRERA AB122MRERA AB162MRERA AB182MRERA</p>  <p>AB242MRERA AB282MRERA</p> <p>AB302MRERA AB382MRERA</p> <p>AB482MRERA AB602MRERA</p>
<p>4-WAY CASSETTE TYPE/PB-950JB</p> <p>AB182MCERA AB242MCERA AB282MCERA</p>   <p>AB302MCERA AB382MCERA AB482MCERA</p>	
<p>MINI 4-WAY CASSETTE TYPE/PB-620KB</p> <p>AB052MCERA(M) AB072MCERA(M) AB092MCERA(M) AB122MCERA(M) AB162MCERA(M) AB182MCERA(M)</p> 	<p>1- WAY CASSETTE TYPE/P1B-1050IB</p> <p>AB052MAERA AB072MAERA AB092MAERA AB122MAERA</p> 
<p>2-WAY CASSETTE TYPE/ P1B-1055IB</p> <p>AB072MBERA AB092MBERA AB122MBERA AB162MBERA AB182MBERA</p> 	<p>LOW ESP DUCT TYPE</p> <p>AD072MLERA AD092MLERA AD122MLERA</p>  <p>AD162MLERA AD182MLERA AD242MLERA</p> 
<p>SLIM LOW ESP DUCT</p> <p>AD072MSERA AD092MSERA AD122MSERA AD162MSERA</p>  <p>AD182MSERA AD242MSERA</p> 	<p>DC SLIM LOW ESP DUCT</p> <p>AD072MSERA(D) AD092MSERA(D) AD122MSERA(D) AD162MSERA(D)</p>  <p>AD182MSERA(D) AD242MSERA(D)</p> 

<p>MED ESP DUCT TYPE (80/120Pa)</p> <p>AD182MZERA AD242MZERA AD282MZERA</p>  <p>AD302MNERA AD382MNERA AD482MNERA</p> 	<p>MED ESP DUCT TYPE (50/96Pa)</p> <p>AD182MMERA AD242MMERA AD282MMERA</p>  <p>AD302MMERA AD382MMERA AD482MMERA</p> 
<p>MED ESP DUCT TYPE (50/100Pa)</p> <p>AD052MJERA AD072MJERA AD092MJERA AD122MJERA AD162MJERA</p>  <p>AD182MJERA AD242MJERA AD282MJERA</p>  <p>AD302MJERA AD382MJERA AD482MJERA</p> 	<p>CONSTANT AIR VOLUME DUCT TYPE</p> <p>AD072MQERA AD092MQERA AD122MQERA AD152MQERA AD182MQERA</p>  <p>AD242MQERA AD282MQERA AD302MQERA</p>  <p>AD362MQERA AD422MQERA AD482MQERA AD542MQERA</p> 
<p>HIGH ESP DUCT TYPE</p> <p>AD182MHERA AD242MHERA AD282MHERA</p>  <p>AD302MHERA AD382MHERA AD482MHERA</p>  <p>AD722MHERA AD962MHERA</p> 	<p>CONVERTIBLE TYPE</p> <p>AC092MCERA AC122MCERA AC162MCERA AC182MCERA AC242MCERA</p>  <p>AC282MFERA AC302MFERA AC382MFERA AC482MFERA</p> 

<p>FRESH AIR</p> <p>AD482MPERA</p>  <p>AD722MPERA</p> <p>AD962MPERA</p> 	<p>BUILT-IN FLOOR STANDING</p> <p>AE072MLERA</p> <p>AE092MLERA</p> <p>AE122MLERA</p> <p>AE162MLERA</p> <p>AE182MLERA</p> <p>AE242MLERA</p> 
<p>CONSOLE</p> <p>AF072MAERA</p> <p>AF092MAERA</p> <p>AF122MAERA</p> <p>AF182MAERA</p> 	<p>EK HIGH WALL</p> <p>AS072MGERA</p> <p>AS092MGERA</p> <p>AS122MGERA</p> <p>AS162MGERA</p> <p>AS182MGERA</p> <p>AS242MGERA</p> 
<p>N HIGH WALL</p> <p>AS052MNERA</p> <p>AS072MNERA</p> <p>AS092MNERA</p> <p>AS122MNERA</p> <p>AS052MNERAB</p> <p>AS072MNERAB</p> <p>AS092MNERAB</p> <p>AS122MNERAB</p> <p>AS162MNERA</p> <p>AS182MNERA</p> <p>AS242MNERA</p> <p>AS282MNERA</p> <p>AS302MNERA</p> <p>AS052MFERA</p> <p>AS072MFERA</p> <p>AS092MFERA</p> <p>AS122MFERA</p> <p>AS052MFERAB</p> <p>AS072MFERAB</p> <p>AS092MFERAB</p> <p>AS122MFERAB</p> <p>AS162MFERA</p> <p>AS182MFERA</p> <p>AS242MFERA</p>  	
<p>MED ESP DUCT TYPE (50/100Pa)</p> <p>AD052MJERAB</p> <p>AD072MJERAB</p> <p>AD092MJERAB</p> <p>AD122MJERAB</p> <p>AD162MJERAB</p> <p>AD182MJERAB</p> <p>AD242MJERAB</p> <p>AD282MJERAB</p>  	

Outdoor units

AV08/10/12/14/16NMVETA



AV18/20/22/24/26NMVETA



AV28/30/32/MVETA



AV34NMVETA



AV36/38/40/42/44/46/48/50/52NMVETA







AV54/56/58/60/62/64/66NMVETA
AV68/70/72/74/76/78NMVETA



AV80/82/84/86/88/90/92NMVETA
AV94/96/98/100/102/104NMVETA



Appearance	Power supply (Ph, V, Hz)	Model	Capacity(kW)	Refrigerant
	3Ph,380-415V, 50/60Hz	AV08NMVETA	25.2	R410A
		AV10NMVETA	28.0	
		AV12NMVETA	33.5	
		AV14NMVETA	40.0	
		AV16NMVETA	45.0	
		AV18NMVETA	50.4	
		AV20NMVETA	56.0	
		AV22NMVETA	61.5	
		AV24NMVETA	68.0	
		AV26NMVETA	73.5	
		AV28NMVETA	80.0	
		AV30NMVETA	85.0	
		AV32NMVETA	90.0	
		AV34NMVETA	95.4	
		AV36NMVETA	100.8	

Appearance	Power supply (Ph, V, Hz)	Model	Capacity(kW)	Refrigerant
	3Ph, 380-415V, 50/60Hz	AV38NMVETA	106.4	R410A
		AV40NMVETA	112.0	
		AV42NMVETA	117.5	
		AV44NMVETA	123.0	
		AV46NMVETA	129.5	
		AV48NMVETA	136.0	
		AV50NMVETA	141.5	
		AV52NMVETA	147.0	
		AV54NMVETA	151.2	
		AV56NMVETA	156.8	
		AV58NMVETA	162.4	
		AV60NMVETA	168.0	
		AV62NMVETA	173.5	
		AV64NMVETA	179.0	
		AV66NMVETA	184.5	
		AV68NMVETA	191.0	
		AV70NMVETA	197.5	
		AV72NMVETA	204.0	
		AV74NMVETA	209.5	
		AV76NMVETA	215.0	
AV78NMVETA	220.5			

Appearance	Power supply (Ph, V, Hz)	Model	Capacity(kW)	Refrigerant
	3Ph,380-415V, 50/60Hz	AV80NMVETA	224.0	R410A
		AV82NMVETA	229.5	
		AV84NMVETA	235.0	
		AV86NMVETA	240.5	
		AV88NMVETA	246.0	
		AV90NMVETA	252.5	
		AV92NMVETA	259.0	
		AV94NMVETA	265.5	
		AV96NMVETA	272.0	
		AV98NMVETA	277.5	
		AV100NMVETA	283.0	
		AV102NMVETA	288.5	
		AV104NMVETA	294.0	

3. Specification

Model			AV08NMVETA	AV10NMVETA
HP			8	10
Combination			/	/
Power supply		Ph/V/Hz	3/380~415/50/60	3/380~415/50/60
Cooling	Rated capacity	kW	25.2	28.0
	Rated capacity	kBtu/h	85.99	95.54
	Rated power input	kW	6.24	7.37
	Max. power input	kW	14.30	15.10
	Rated current	A	10.53	12.44
	Max. current	A	23.81	25.14
	EER		4.04	3.80
	AEER		7.25	7.09
Heating	Rated capacity	kw	25.2	28.0
	Rated capacity	kBtu/h	85.99	95.54
	Rated power input	kW	5.56	6.32
	Max. power input	kW	11.69	12.19
	Rated current	A	9.67	10.99
	Max. current	A	19.47	20.30
	COP		4.53	4.43
	ACOP		4.61	4.51
Compressor	Brand		MITSUBISHI ELECTRIC	MITSUBISHI ELECTRIC
	Model		ANB66FZXMT	ANB66FZXMT
	Type		DC INV. SCROLL	DC INV. SCROLL
	Compressor quantity		1INV	1INV
	Capacity	W	21300	21300
	Power Input	W	6600	6600
	Rated current(RLA)	A	21.5	21.5
	Speed	rps	60	60
	Crankcase Heater	W	66	66
	Refrigerant oil brand		IDEMITSUKOSAN CO.,LTD	IDEMITSUKOSAN CO.,LTD
	Refrigerant oil type		FVC68D	FVC68D
Refrigerant oil charge	ml	2300+1500	2300+1500	
Outdoor fan motor	Brand		BROAD-OCEAN	BROAD-OCEAN
	Model		ZWK924D500007	ZWK924D500007
	Voltage		DC540V	DC540V
	IP Class		IP44	IP44
	Type/quantity		DC/1	DC/1
	Insulation class		B	B
	Safe class		I	I
	Power Input	W	1600	1600
	Output	W	1300	1300
	Rated current	A		
	Caocitor	μF	/	/
	Speed	rpm	0~1100	0~1100

Model			AV08NMVETA	AV10NMVETA	
Outdoor fan	Brand		Shun wei	Shun wei	
	Model		/	/	
	Material		ABS+20%GF	ABS+20%GF	
	Type		Axial	Axial	
	Diameter	mm	Φ700	Φ700	
	Height	mm	204	204	
Outdoor coil	Number of rows		3	3	
	Tube pitch(a)x row pitch(b)	mm	21×18.186	21×18.186	
	Fin spacing	mm	1.6	1.6	
	Fin type(code)		Hydrophilic aluminum	Hydrophilic aluminum	
	Fin coating Type	Optional	Clear lacquer	Clear lacquer	
	Salt Spray Test Duration	Hour	168	168	
	Tube outside dia.and type	mm		INNERGROOVE TUBE	INNERGROOVE TUBE
				Φ7	Φ7
Coil length x height	mm	2245*1260+2158*1260 +2065*1260	2245*1260+2158*1260 +2065*1260		
Number or circuits		29	29		
Cabinet coating	Coating type		Powerr Coating	Powerr Coating	
	Salt Spray Test Duration	Hour	72	72	
	Sheet Metal Material		Hot zinc plate	Hot zinc plate	
	Sheet Metal Thickness	mm	1	1	
Control panel enclosure IP class	standard		IP24	IP24	
Outdoor air flow (cooling/heating)	m ³ /h		11000	11000	
External static pressure	Pa		110	110	
Outdoor sound level(sound power level) (H)	dB(A)		81	82	
Outdoor unit	Diamension(W*D*H)	mm	980/750/1690	980/750/1690	
	Packing(W*D*H)	mm	1070/850/1858	1070/850/1858	
	Net weight	kg	255	255	
	Gross weight	kg	280	280	
Refrigerant	Type		R410A	R410A	
	Charged volume	kg	10	10	
Throttle type			EXV	EXV	
Design pressure	Mpa		4.15	4.15	

Model			AV08NMVETA	AV10NMVETA
Frigerant piping	Liquid pipe	mm	9.52	9.52
	Gas pipe	mm	19.05	22.22
	Oil pipe	mm	/	/
	Total pipe length	m	1000	1000
	Max. pipe length(Equivalent/Actual)	m	260/220	260/220
	Max. Diff. indoor/outdoor unit*1	m	110/90	110/90
	Standard Diff. indoor/outdoor unit	m	50/40	50/40
	Max./standard Diff. indoor/indoor unit*1	m	30/18	30/18
Connectable indoor unit ratio		%	50~130	50~130
Maximum indoor units		Piece	13	16
Connection wiring	Max. fuse current	A	25.0	32.0
	Min. wiring current	A	20.30	21.80
	Power wiring	mm ²	6	6
	Signal wiring	mm ²	2×0.75	2×0.75
Operation Range		°C	Cooling:-5~52 Heating:-27~21	Cooling:-5~52 Heating:-27~21

Nominal condition: indoor temperature (cooling): 27°C DB/19°C WB, indoor temperature (heating): 20°C DB/14.5°C WB.

Outdoor temperature(cooling): 35°C DB/24°C WB, outdoor temperature(heating): 7°C DB/6°C WB The data is measured with 7.5m equivalent pipe and 0 m height difference.

The noise level will be measured in the third octave band limited values in the semi-anechoic chamber, using a Real Time Analyser calibrated sound intensity meter. It is a sound pressure noise level.

*1 If the total pipe length is from 500 to 1000m or the height difference between the outdoor and indoor units is from 50 to 110m or the height difference between the indoor units is from 18 to 30m, you Must contact your local distributor/dealer for individual design and production.

Model			AV12NMVETA	AV14NMVETA
HP			12	14
Combination			/	/
Power supply		Ph/V/Hz	3/380~415/50/60	3/380~415/50/60
Cooling	Rated capacity	kW	33.5	40.0
	Rated capacity	kBtu/h	114.31	136.49
	Rated power input	kW	9.31	11.94
	Max. power input	kW	16.32	17.58
	Rated current	A	15.71	20.16
	Max. current	A	27.17	29.27
	EER		3.60	3.35
	AEER		6.69	6.60
Heating	Rated capacity	kw	33.5	40.0
	Rated capacity	kBtu/h	114.31	136.49
	Rated power input	kW	7.71	9.71
	Max. power input	kW	12.69	16.10
	Rated current	A	13.40	16.88
	Max. current	A	21.13	26.81
	COP		4.35	4.12
	ACOP		4.51	4.31
Compressor	Brand		MITSUBISHI ELECTRIC	MITSUBISHI ELECTRIC
	Model		ANB66FZXMT	ANB78FZXMT
	Type		DC INV. SCROLL	DC INV. SCROLL
	Compressor quantity		1INV	1INV
	Capacity	W	21300	25200
	Power Input	W	6600	7700
	Rated current(RLA)	A	21.5	26
	Speed	rps	60	60
	Crankcase Heater	W	66	66
	Refrigerant oil brand		IDEMITSUKOSAN CO.,LTD	IDEMITSUKOSAN CO.,LTD
	Refrigerant oil type		FVC68D	FVC68D
Refrigerant oil charge	ml	2300+1500	2300+1500	
Outdoor fan motor	Brand		BROAD-OCEAN	BROAD-OCEAN
	Model		ZWK924D500007	ZWK924D500007
	Voltage		DC540V	DC540V
	IP Class		IP44	IP44
	Type/quantity		DC/1	DC/1
	Insulation class		B	B
	Safe class		I	I
	Power Input	W	1600	1600
	Output	W	1300	1300
	Rated current	A		
	Caocitor	μF	/	/
	Speed	rpm	0~1100	0~1100

Model			AV12NMVETA	AV14NMVETA
Outdoor fan	Brand		Shun wei	Shun wei
	Model		/	/
	Material		ABS+20%GF	ABS+20%GF
	Type		Axial	Axial
	Diameter	mm	Φ700	Φ700
	Height	mm	204	204
Outdoor coil	Number of rows		3	3
	Tube pitch(a)x row pitch(b)	mm	21×18.186	21×18.186
	Fin spacing	mm	1.6	1.6
	Fin type(code)		Hydrophilic aluminum	Hydrophilic aluminum
	Fin coating Type	Optional	Clear lacquer	Clear lacquer
	Salt Spray Test Duration	Hour	168	168
	Tube outside dia.and type	mm	INNERGROOVE TUBE Φ7	INNERGROOVE TUBE Φ7
	Coil length x height	mm	2245*1260+2158*1260 +2065*1260	2245*1260+2158*1260 +2065*1260
Number or circuits		29	29	
Cabinet coating	Coating type		Powerr Coating	Powerr Coating
	Salt Spray Test Duration	Hour	72	72
	Sheet Metal Material		Hot zinc plate	Hot zinc plate
	Sheet Metal Thickness	mm	1	1
Control panel enclosure IP class	standard	IP24	IP24	
Outdoor air flow (cooling/heating)	m ³ /h	12000	13500	
External static pressure	Pa	110	110	
Outdoor sound level(sound power level) (H)	dB(A)	88	88	
Outdoor unit	Diamension(W*D*H)	mm	980/750/1690	980/750/1690
	Packing(W*D*H)	mm	1070/850/1858	1070/850/1858
	Net weight	kg	255	255
	Gross weight	kg	280	280
Refrigerant	Type		R410A	R410A
	Charged volume	kg	10	10
Throttle type		EXV	EXV	
Design pressure	Mpa	4.15	4.15	

Model			AV12NMVETA	AV14NMVETA
Frigerant piping	Liquid pipe	mm	12.7	12.7
	Gas pipe	mm	25.4	25.4
	Oil pipe	mm	/	/
	Total pipe length	m	1000	1000
	Max. pipe length(Equivalent/Actual)	m	260/220	260/220
	Max. Diff. indoor/outdoor unit*1	m	110/90	110/90
	Standard Diff. indoor/outdoor unit	m	50/40	50/40
	Max./standard Diff. indoor/indoor unit*1	m	30/18	30/18
Connectable indoor unit ratio		%	50~130	50~130
Maximum indoor units		Piece	20	24
Connection wiring	Max. fuse current	A	32.0	40.0
	Min. wiring current	A	23.30	27.70
	Power wiring	mm ²	6	10
	Signal wiring	mm ²	2×0.75	2×0.75
Operation Range		°C	Cooling:-5~52 Heating:-27~21	Cooling:-5~52 Heating:-27~21

Nominal condition: indoor temperature (cooling): 27°C DB/19°C WB, indoor temperature (heating): 20°C DB/14.5°C WB.

Outdoor temperature(cooling): 35°C DB/24°C WB, outdoor temperature(heating): 7°C DB/6°C WB The data is measured with 7.5m equivalent pipe and 0 m height difference.

The noise level will be measured in the third octave band limited values in the semi-anechoic chamber, using a Real Time Analyser calibrated sound intensity meter. It is a sound pressure noise level.

*1 If the total pipe length is from 500 to 1000m or the height difference between the outdoor and indoor units is from 50 to 110m or the height difference between the indoor units is from 18 to 30m, you Must contact your local distributor/dealer for individual design and production.

Model			AV16NMVETA	AV18NMVETA
HP			16	18
Combination			/	/
Power supply		Ph/V/Hz	3/380~415/50/60	3/380~415/50/60
Cooling	Rated capacity	kW	45.0	50.4
	Rated capacity	kBtu/h	153.55	171.97
	Rated power input	kW	13.24	15.70
	Max. power input	kW	20.69	25.90
	Rated current	A	22.34	26.51
	Max. current	A	34.50	40.30
	EER		3.40	3.21
	AEER		6.36	6.78
Heating	Rated capacity	kw	45.0	50.4
	Rated capacity	kBtu/h	153.55	171.97
	Rated power input	kW	10.92	12.81
	Max. power input	kW	19.56	21.93
	Rated current	A	18.99	22.27
	Max. current	A	32.57	36.51
	COP		4.12	3.93
	ACOP		4.10	4.31
Compressor	Brand		MITSUBISHI ELECTRIC	MITSUBISHI ELECTRIC
	Model		ANB78FZXMT	ANB52FZJMT*2
	Type		DC INV. SCROLL	DC INV. SCROLL
	Compressor quantity		1INV	2INV
	Capacity	W	25200	16800*2
	Power Input	W	7700	5250*2
	Rated current(RLA)	A	26	16.5*2
	Speed	rps	60	60
	Crankcase Heater	W	66	132
	Refrigerant oil brand		IDEMITSUKOSAN CO.,LTD	IDEMITSUKOSAN CO.,LTD
	Refrigerant oil type		FVC68D	FVC68D
Refrigerant oil charge	ml	2300+1500	(2300+1500)*2	
Outdoor fan motor	Brand		BROAD-OCEAN	BROAD-OCEAN
	Model		ZWK924D500007	ZWK924D500002 +ZWK924D500002
	Voltage		DC540V	DC540V
	IP Class		IP44	IP44
	Type/quantity		DC/1	DC/2
	Insulation class		B	B
	Safe class		I	I
	Power Input	W	1600	2320
	Output	W	1300	1800
	Rated current	A		8
	Caocitor	μF	/	/
Speed	rpm	0~1100	0~1180	

Model			AV16NMVETA	AV18NMVETA	
Outdoor fan	Brand		Shun wei	Tian Da	
	Model		/	/	
	Material		ABS+20%GF	ABS+20%GF	
	Type		Axial	Axial	
	Diameter	mm	Φ700	Φ642	
	Height	mm	204	198	
Outdoor coil	Number of rows		3	3	
	Tube pitch(a)x row pitch(b)	mm	21×18.186	21×18.186	
	Fin spacing	mm	1.6	1.6	
	Fin type(code)		Hydrophilic aluminum	Hydrophilic aluminum	
	Fin coating Type	Optional	Clear lacquer	Clear lacquer	
	Salt Spray Test Duration	Hour	168	168	
	Tube outside dia.and type	mm		INNERGROOVE TUBE	INNERGROOVE TUBE
				Φ7	Φ7
Coil length x height	mm	2245*1260+2158*1260 +2065*1260	2843*1260+2757*1260 +2669*1260		
Number or circuits		29	29		
Cabinet coating	Coating type		Powerr Coating	Powerr Coating	
	Salt Spray Test Duration	Hour	72	72	
	Sheet Metal Material		Hot zinc plate	Hot zinc plate	
	Sheet Metal Thickness	mm	1	1	
Control panel enclosure IP class	standard		IP24	IP24	
Outdoor air flow (cooling/heating)	m ³ /h		13500	17000	
External static pressure	Pa		110	110	
Outdoor sound level(sound power level) (H)	dB(A)		88	88	
Outdoor unit	Diamension(W*D*H)	mm	980/750/1690	1410/750/1690	
	Packing(W*D*H)	mm	1070/850/1858	1515/850/1858	
	Net weight	kg	255	385	
	Gross weight	kg	280	410	
Refrigerant	Type		R410A	R410A	
	Charged volume	kg	10	10	
Throttle type			EXV	EXV	
Design pressure	Mpa		4.15	4.15	

Model			AV16NMVETA	AV18NMVETA
Frigerant piping	Liquid pipe	mm	12.7	15.88
	Gas pipe	mm	28.58	28.58
	Oil pipe	mm	/	/
	Total pipe length	m	1000	1000
	Max. pipe length(Equivalent/Actual)	m	260/220	260/220
	Max. Diff. indoor/outdoor unit*1	m	110/90	110/90
	Standard Diff. indoor/outdoor unit	m	50/40	50/40
	Max./standard Diff. indoor/indoor unit*1	m	30/18	30/18
Connectable indoor unit ratio		%	50~130	50~130
Maximum indoor units		Piece	27	30
Connection wiring	Max. fuse current	A	40.0	50.0
	Min. wiring current	A	32.40	36.10
	Power wiring	mm ²	10	10
	Signal wiring	mm ²	2×0.75	2×0.75
Operation Range		°C	Cooling:-5~52 Heating:-27~21	Cooling:-5~52 Heating:-27~21

Nominal condition: indoor temperature (cooling): 27°C DB/19°C WB, indoor temperature (heating): 20°C DB/14.5°C WB.

Outdoor temperature(cooling): 35°C DB/24°C WB, outdoor temperature(heating): 7°C DB/6°C WB The data is measured with 7.5m equivalent pipe and 0 m height difference.

The noise level will be measured in the third octave band limited values in the semi-anechoic chamber, using a Real Time Analyser calibrated sound intensity meter. It is a sound pressure noise level.

*1 If the total pipe length is from 500 to 1000m or the height difference between the outdoor and indoor units is from 50 to 110m or the height difference between the indoor units is from 18 to 30m, you Must contact your local distributor/dealer for individual design and production.

Model			AV20NMVETA	AV22NMVETA
HP			20	22
Combination			/	/
Power supply		Ph/V/Hz	3/380~415/50/60	3/380~415/50/60
Cooling	Rated capacity	kW	56.0	61.5
	Rated capacity	kBtu/h	191.08	209.85
	Rated power input	kW	16.62	18.30
	Max. power input	kW	28.91	31.82
	Rated current	A	28.05	30.90
	Max. current	A	46.30	51.91
	EER		3.37	3.36
	AEER		6.75	6.54
Heating	Rated capacity	kw	56.0	61.5
	Rated capacity	kBtu/h	191.08	209.85
	Rated power input	kW	14.23	16.14
	Max. power input	kW	24.70	25.69
	Rated current	A	24.75	28.06
	Max. current	A	41.13	42.78
	COP		3.93	3.81
	ACOP		4.38	4.39
Compressor	Brand		MITSUBISHI ELECTRIC	MITSUBISHI ELECTRIC
	Model		ANB52FZJMT*2	ANB66FZXMT*2
	Type		DC INV. SCROLL	DC INV. SCROLL
	Compressor quantity		2INV	2INV
	Capacity	W	16800*2	21300*2
	Power Input	W	5250*2	6600*2
	Rated current(RLA)	A	16.5*2	21.5*2
	Speed	rps	60	60
	Crankcase Heater	W	132	132
	Refrigerant oil brand		IDEMITSUKOSAN CO.,LTD	IDEMITSUKOSAN CO.,LTD
	Refrigerant oil type		FVC68D	FVC68D
Refrigerant oil charge	ml	(2300+1500)*2	(2300+1500)*2	
Outdoor fan motor	Brand		BROAD-OCEAN	BROAD-OCEAN
	Model		ZWK924D500002 +ZWK924D500002	ZWK924D500002 +ZWK924D500002
	Voltage		DC540V	DC540V
	IP Class		IP44	IP44
	Type/quantity		DC/2	DC/2
	Insulation class		B	B
	Safe class		I	I
	Power Input	W	2320	2320
	Output	W	1800	1800
	Rated current	A	8	8
	Capacitor	μF	/	/
	Speed	rpm	0~1180	0~1180

Model			AV20NMVETA	AV22NMVETA
Outdoor fan	Brand		Tian Da	Tian Da
	Model		/	/
	Material		ABS+20%GF	ABS+20%GF
	Type		Axial	Axial
	Diameter	mm	Φ642	Φ642
	Height	mm	198	198
Outdoor coil	Number of rows		3	3
	Tube pitch(a)x row pitch(b)	mm	21×18.186	21×18.186
	Fin spacing	mm	1.6	1.6
	Fin type(code)		Hydrophilic aluminum	Hydrophilic aluminum
	Fin coating Type	Optional	Clear lacquer	Clear lacquer
	Salt Spray Test Duration	Hour	168	168
	Tube outside dia.and type	mm	INNERGROOVE TUBE Φ7	INNERGROOVE TUBE Φ7
	Coil length x height	mm	2843*1260+2757*1260 +2669*1260	2843*1260+2757*1260 +2669*1260
Number or circuits		29	29	
Cabinet coating	Coating type		Powerr Coating	Powerr Coating
	Salt Spray Test Duration	Hour	72	72
	Sheet Metal Material		Hot zinc plate	Hot zinc plate
	Sheet Metal Thickness	mm	1	1
Control panel enclosure IP class	standard	IP24	IP24	
Outdoor air flow (cooling/heating)	m ³ /h	17000	18000	
External static pressure	Pa	110	110	
Outdoor sound level(sound power level) (H)	dB(A)	88	88	
Outdoor unit	Diamension(W*D*H)	mm	1410/750/1690	1410/750/1690
	Packing(W*D*H)	mm	1515/850/1858	1515/850/1858
	Net weight	kg	385	385
	Gross weight	kg	410	410
Refrigerant	Type		R410A	R410A
	Charged volume	kg	10	10
Throttle type		EXV	EXV	
Design pressure	Mpa	4.15	4.15	

Model			AV20NMVETA	AV22NMVETA
Frigerant piping	Liquid pipe	mm	15.88	15.88
	Gas pipe	mm	28.58	28.58
	Oil pipe	mm	/	/
	Total pipe length	m	1000	1000
	Max. pipe length(Equivalent/Actual)	m	260/220	260/220
	Max. Diff. indoor/outdoor unit*1	m	110/90	110/90
	Standard Diff. indoor/outdoor unit	m	50/40	50/40
	Max./standard Diff. indoor/indoor unit*1	m	30/18	30/18
Connectable indoor unit ratio		%	50~130	50~130
Maximum indoor units		Piece	33	36
Connection wiring	Max. fuse current	A	50.0	63.0
	Min. wiring current	A	42.40	48.10
	Power wiring	mm ²	16	16
	Signal wiring	mm ²	2×0.75	2×0.75
Operation Range		°C	Cooling:-5~52 Heating:-27~21	Cooling:-5~52 Heating:-27~21

Nominal condition: indoor temperature (cooling): 27°C DB/19°C WB, indoor temperature (heating): 20°C DB/14.5°C WB.

Outdoor temperature(cooling): 35°C DB/24°C WB, outdoor temperature(heating): 7°C DB/6°C WB The data is measured with 7.5m equivalent pipe and 0 m height difference.

The noise level will be measured in the third octave band limited values in the semi-anechoic chamber, using a Real Time Analyser calibrated sound intensity meter. It is a sound pressure noise level.

*1 If the total pipe length is from 500 to 1000m or the height difference between the outdoor and indoor units is from 50 to 110m or the height difference between the indoor units is from 18 to 30m, you Must contact your local distributor/dealer for individual design and production.

Model			AV24NMVETA	AV26NMVETA
HP			24	26
Combination			/	/
Power supply		Ph/V/Hz	3/380~415/50/60	3/380~415/50/60
Cooling	Rated capacity	kW	68.0	73.5
	Rated capacity	kBtu/h	232.03	250.79
	Rated power input	kW	21.94	24.75
	Max. power input	kW	32.81	35.35
	Rated current	A	31.42	35.87
	Max. current	A	54.12	58.86
	EER		3.10	2.97
	AEER		5.97	5.68
Heating	Rated capacity	kw	68.0	73.5
	Rated capacity	kBtu/h	232.03	250.79
	Rated power input	kW	18.86	21.62
	Max. power input	kW	30.40	32.45
	Rated current	A	32.80	37.60
	Max. current	A	50.62	54.03
	COP		3.61	3.40
	ACOP		4.34	3.88
Compressor	Brand		MITSUBISHI ELECTRIC	MITSUBISHI ELECTRIC
	Model		ANB66FZXMT*2	ANB78FZXMT*2
	Type		DC INV. SCROLL	DC INV. SCROLL
	Compressor quantity		2INV	2INV
	Capacity	W	21300*2	25200*2
	Power Input	W	6600*2	7700*2
	Rated current(RLA)	A	21.5*2	26*2
	Speed	rps	60	60
	Crankcase Heater	W	132	132
	Refrigerant oil brand		IDEMITSUKOSAN CO.,LTD	IDEMITSUKOSAN CO.,LTD
	Refrigerant oil type		FVC68D	FVC68D
Refrigerant oil charge	ml	(2300+1500)*2	(2300+1500)*2	
Outdoor fan motor	Brand		BROAD-OCEAN	BROAD-OCEAN
	Model		ZWK924D500002 +ZWK924D500002	ZWK924D500002 +ZWK924D500002
	Voltage		DC540V	DC540V
	IP Class		IP44	IP44
	Type/quantity		DC/2	DC/1+DC/1
	Insulation class		B	B
	Safe class		I	I
	Power Input	W	2320	2320
	Output	W	1800	1800
	Rated current	A	8	8
	Caocitor	μF	/	/
	Speed	rpm	0~1180	0~1180

Model			AV24NMVETA	AV26NMVETA	
Outdoor fan	Brand		Tian Da	Tian Da	
	Model		/	/	
	Material		ABS+20%GF	ABS+20%GF	
	Type		Axial	Axial	
	Diameter	mm	Φ642	Φ642	
	Height	mm	198	198	
Outdoor coil	Number of rows		3	3	
	Tube pitch(a)x row pitch(b)	mm	21×18.186	21×18.186	
	Fin spacing	mm	1.6	1.6	
	Fin type(code)		Hydrophilic aluminum	Hydrophilic aluminum	
	Fin coating Type	Optional	Clear lacquer	Clear lacquer	
	Salt Spray Test Duration	Hour	168	168	
	Tube outside dia.and type	mm		INNERGROOVE TUBE	INNERGROOVE TUBE
				Φ7	Φ7
Coil length x height	mm	2843*1260+2757*1260 +2669*1260	2843*1260+2757*1260 +2669*1260		
Number or circuits		29	29		
Cabinet coating	Coating type		Powerr Coating	Powerr Coating	
	Salt Spray Test Duration	Hour	72	72	
	Sheet Metal Material		Hot zinc plate	Hot zinc plate	
	Sheet Metal Thickness	mm	1	1	
Control panel enclosure IP class	standard		IP24	IP24	
Outdoor air flow (cooling/heating)	m ³ /h		18000	19000	
External static pressure	Pa		110	110	
Outdoor sound level(sound power level) (H)	dB(A)		90	90	
Outdoor unit	Diamension(W*D*H)	mm	1410/750/1690	1410/750/1690	
	Packing(W*D*H)	mm	1515/850/1858	1515/850/1858	
	Net weight	kg	385	385	
	Gross weight	kg	410	410	
Refrigerant	Type		R410A	R410A	
	Charged volume	kg	10	10	
Throttle type			EXV	EXV	
Design pressure	Mpa		4.15	4.15	

Model			AV24NMVETA	AV26NMVETA
Frigerant piping	Liquid pipe	mm	15.88	15.88
	Gas pipe	mm	28.58	28.58
	Oil pipe	mm	/	/
	Total pipe length	m	1000	1000
	Max. pipe length(Equivalent/Actual)	m	260/220	260/220
	Max. Diff. indoor/outdoor unit*1	m	110/90	110/90
	Standard Diff. indoor/outdoor unit	m	50/40	50/40
	Max./standard Diff. indoor/indoor unit*1	m	30/18	30/18
Connectable indoor unit ratio		%	50~130	50~130
Maximum indoor units		Piece	40	43
Connection wiring	Max. fuse current	A	63.0	63.0
	Min. wiring current	A	49.10	55.80
	Power wiring	mm ²	25	25
	Signal wiring	mm ²	2×0.75	2×0.75
Operation Range		°C	Cooling:-5~52 Heating:-27~21	Cooling:-5~52 Heating:-27~21

Nominal condition: indoor temperature (cooling): 27°C DB/19°C WB, indoor temperature (heating): 20°C DB/14.5°C WB.

Outdoor temperature(cooling): 35°C DB/24°C WB, outdoor temperature(heating): 7°C DB/6°C WB The data is measured with 7.5m equivalent pipe and 0 m height difference.

The noise level will be measured in the third octave band limited values in the semi-anechoic chamber, using a Real Time Analyser calibrated sound intensity meter. It is a sound pressure noise level.

*1 If the total pipe length is from 500 to 1000m or the height difference between the outdoor and indoor units is from 50 to 110m or the height difference between the indoor units is from 18 to 30m, you Must contact your local distributor/dealer for individual design and production.

Model			AV28NMVETA	AV30NMVETA
HP			28	30
Combination			14+14	14+16
Power supply		Ph/V/Hz	3/380~415/50/60	3/380~415/50/60
Cooling	Rated capacity	kW	80.0	85.0
	Rated capacity	kBtu/h	272.97	290.03
	Rated power input	kW	23.88	25.18
	Max. power input	kW	35.16	38.27
	Rated current	A	40.32	42.50
	Max. current	A	58.54	63.77
	EER		3.35	3.38
	AEER		5.68	6.54
Heating	Rated capacity	kw	80.0	85.0
	Rated capacity	kBtu/h	272.97	290.03
	Rated power input	kW	19.42	20.63
	Max. power input	kW	32.20	35.66
	Rated current	A	33.76	35.87
	Max. current	A	53.61	59.38
	COP		4.12	4.12
	ACOP		4.31	4.19
Compressor	Brand		MITSUBISHI ELECTRIC	MITSUBISHI ELECTRIC
	Model		ANB78FZXMT+ANB78FZXMT	ANB78FZXMT+ANB78FZXMT
	Type		DC INV. SCROLL	DC INV. SCROLL
	Compressor quantity		2INV	2INV
	Capacity	W	25200+25200	25200+25200
	Power Input	W	7700+7700	7700+7700
	Rated current(RLA)	A	26+26	26+26
	Speed	rps	60	60
	Crankcase Heater	W	66+66	66+66
	Refrigerant oil brand		IDEMITSUKOSAN CO.,LTD	IDEMITSUKOSAN CO.,LTD
	Refrigerant oil type		FVC68D	FVC68D
Refrigerant oil charge	ml	(2300+1500)*2	(2300+1500)*2	
Outdoor fan motor	Brand		BROAD-OCEAN	BROAD-OCEAN
	Model		ZWK924D500007 +ZWK924D500007	ZWK924D500007 +ZWK924D500007
	Voltage		DC540V	DC540V
	IP Class		IP44	IP44
	Type/quantity		DC/1+DC/1	DC/1+DC/1
	Insulation class		B	B
	Safe class		I	I
	Power Input	W	1600+1600	1600+1600
	Output	W	1300+1300	1300+1300
	Rated current	A	8+8	8+8
	Capacitor	μF	/	/
	Speed	rpm	0~1180	0~1180

Model			AV28NMVETA	AV30NMVETA	
Outdoor fan	Brand		Shun wei+Shun wei	Shun wei+Shun wei	
	Model		/	/	
	Material		ABS+20%GF	ABS+20%GF	
	Type		Axial	Axial	
	Diameter	mm	Φ700+Φ700	Φ700+Φ700	
	Height	mm	204+204	204+204	
Outdoor coil	Number of rows		3+3	3+3	
	Tube pitch(a)x row pitch(b)	mm	21×18.186	21×18.186	
	Fin spacing	mm	1.6	1.6	
	Fin type(code)		Hydrophilic aluminum	Hydrophilic aluminum	
	Fin coating Type	Optional	Clear lacquer	Clear lacquer	
	Salt Spray Test Duration	Hour	168	168	
	Tube outside dia.and type	mm		INNERGROOVE TUBE	INNERGROOVE TUBE
				Φ7	Φ7
Coil length x height	mm	(2245*1260+2158*1260+2065*1260)+(2245*1260+2158*1260+2065*1260)	(2245*1260+2158*1260+2065*1260)+(2245*1260+2158*1260+2065*1260)		
Number or circuits		2601900	29		
Cabinet coating	Coating type		Powerr Coating	Powerr Coating	
	Salt Spray Test Duration	Hour	72	72	
	Sheet Metal Material		Hot zinc plate	Hot zinc plate	
	Sheet Metal Thickness	mm	1	1	
Control panel enclosure IP class	standard		IP24	IP24	
Outdoor air flow (cooling/heating)	m ³ /h		27000	27000	
External static pressure	Pa		110	110	
Outdoor sound level(sound power level) (H)	dB(A)		91	91	
Outdoor unit	Dimension(W*D*H)	mm	980/750/1690	980/750/1690	
			+980/750/1690	+980/750/1690	
	Packing(W*D*H)	mm	1070/850/1858	1070/850/1858	
			+1070/850/1858	+1070/850/1858	
Net weight	kg	255+255	255+255		
Gross weight	kg	280+280	280+280		
Refrigerant	Type		R410A	R410A	
	Charged volume	kg	20	20	
Throttle type			EXV	EXV	
Design pressure	Mpa		4.15	4.15	

Model			AV28NMVETA	AV30NMVETA
Frigerant piping	Liquid pipe	mm	15.88	19.05
	Gas pipe	mm	28.58	31.8
	Oil pipe	mm	/	/
	Total pipe length	m	1000	1000
	Max. pipe length(Equivalent/Actual)	m	260/220	260/220
	Max. Diff. indoor/outdoor unit*1	m	110/90	110/90
	Standard Diff. indoor/outdoor unit	m	50/40	50/40
	Max./standard Diff. indoor/indoor unit*1	m	30/18	30/18
Connectable indoor unit ratio		%	50~130	50~130
Maximum indoor units		Piece	47	50
Connection wiring	Max. fuse current	A	80.00	80.00
	Min. wiring current	A	55.40	60.10
	Power wiring	mm ²	10+10	10+10
	Signal wiring	mm ²	2×0.75	2×0.75
Operation Range		°C	Cooling:-5~52 Heating:-27~21	Cooling:-5~52 Heating:-27~21

Nominal condition: indoor temperature (cooling): 27°C DB/19°C WB, indoor temperature (heating): 20°C DB/14.5°C WB.

Outdoor temperature(cooling): 35°C DB/24°C WB, outdoor temperature(heating): 7°C DB/6°C WB The data is measured with 7.5m equivalent pipe and 0 m height difference.

The noise level will be measured in the third octave band limited values in the semi-anechoic chamber, using a Real Time Analyser calibrated sound intensity meter. It is a sound pressure noise level.

*1 If the total pipe length is from 500 to 1000m or the height difference between the outdoor and indoor units is from 50 to 110m or the height difference between the indoor units is from 18 to 30m, you Must contact your local distributor/dealer for individual design and production.

Model			AV32NMVETA	AV34NMVETA
HP			32	34
Combination			16+16	16+18
Power supply		Ph/V/Hz	3/380~415/50/60	3/380~415/50/60
Cooling	Rated capacity	kW	90.0	95.4
	Rated capacity	kBtu/h	307.09	325.52
	Rated power input	kW	26.47	28.94
	Max. power input	kW	41.38	46.59
	Rated current	A	44.69	48.85
	Max. current	A	69.00	74.80
	EER		3.40	3.30
	AEER		6.42	6.63
Heating	Rated capacity	kw	90.0	95.4
	Rated capacity	kBtu/h	307.09	325.52
	Rated power input	kW	21.84	23.73
	Max. power input	kW	39.12	41.49
	Rated current	A	37.98	41.27
	Max. current	A	65.14	69.08
	COP		4.12	4.01
	ACOP		4.10	4.21
Compressor	Brand		MITSUBISHI ELECTRIC	MITSUBISHI ELECTRIC
	Model		ANB78FZXMT +ANB78FZXMT	ANB78FZXMT ANB52FZJMT*2
	Type		DC INV. SCROLL	DC INV. SCROLL
	Compressor quantity		2INV	3INV
	Capacity	W	25200+25200	25200+(16800*2)
	Power Input	W	7700+7700	7700+5250*2
	Rated current(RLA)	A	26+26	26+16.5*2
	Speed	rps	60	60
	Crankcase Heater	W	66+66	66+132
	Refrigerant oil brand		IDEMITSUKOSAN CO.,LTD	IDEMITSUKOSAN CO.,LTD
	Refrigerant oil type		FVC68D	FVC68D
Refrigerant oil charge	ml	(2300+1500)*2	(2300+1500) + (2300+1500)*2	
Outdoor fan motor	Brand		BROAD-OCEAN	BROAD-OCEAN
	Model		ZWK924D500007 +ZWK924D500007	ZWK924D500007+(ZWK924D500002+ZWK924D500002)
	Voltage		DC540V	DC540V
	IP Class		IP44	IP44
	Type/quantity		DC/1+DC/2	DC/2+DC/2
	Insulation class		B	B
	Safe class		I	I
	Power Input	W	1600+1600	1600+2320
	Output	W	1300+1300	1300+1800
	Rated current	A	8+8	8+8
	Caocitor	μF	/	/
Speed	rpm	0~1180	0~1180	

Model			AV32NMVETA	AV34NMVETA	
Outdoor fan	Brand		Shun wei+Shun wei	Shun wei+Tian Da	
	Model		/	/	
	Material		ABS+20%GF	ABS+20%GF	
	Type		Axial	Axial	
	Diameter	mm	Φ700+Φ700	Φ700+Φ642	
	Height	mm	204+204	204+198	
Outdoor coil	Number of rows		3+3	3+3	
	Tube pitch(a)x row pitch(b)	mm	21×18.186	21×18.186	
	Fin spacing	mm	1.6	1.6	
	Fin type(code)		Hydrophilic aluminum	Hydrophilic aluminum	
	Fin coating Type	Optional	Clear lacquer	Clear lacquer	
	Salt Spray Test Duration	Hour	168	168	
	Tube outside dia.and type	mm		INNERGROOVE TUBE	INNERGROOVE TUBE
				Φ7	Φ7
Coil length x height	mm	(2245*1260+2158*1260+2065*1260)+(2245*1260+2158*1260+2065*1260)	(2245*1260+2158*1260+2065*1260)+(2843*1260+2757*1260+2669*1260)		
Number or circuits		29	29		
Cabinet coating	Coating type		Power Coating	Power Coating	
	Salt Spray Test Duration	Hour	72	72	
	Sheet Metal Material		Hot zinc plate	Hot zinc plate	
	Sheet Metal Thickness	mm	1	1	
Control panel enclosure IP class	standard		IP24	IP24	
Outdoor air flow (cooling/heating)	m ³ /h		27000	30500	
External static pressure	Pa		110	110	
Outdoor sound level(sound power level) (H)	dB(A)		91	91	
Outdoor unit	Dimension(W*D*H)	mm	980/750/1690	980/750/1690	
			+980/750/1690	+1410/750/1690	
	Packing(W*D*H)	mm	1070/850/1858	1070/850/1858	
			+1070/850/1858	+1515/850/1858	
Net weight	kg	255+255	255+385		
Gross weight	kg	280+280	280+410		
Refrigerant	Type		R410A	R410A	
	Charged volume	kg	20	20	
Throttle type			EXV	EXV	
Design pressure	Mpa		4.15	4.15	

Model			AV32NMVETA	AV34NMVETA
Frigerant piping	Liquid pipe	mm	19.05	19.05
	Gas pipe	mm	31.8	31.8
	Oil pipe	mm	/	/
	Total pipe length	m	1000	1000
	Max. pipe length(Equivalent/Actual)	m	260/220	260/220
	Max. Diff. indoor/outdoor unit*1	m	110/90	110/90
	Standard Diff. indoor/outdoor unit	m	50/40	50/40
	Max./standard Diff. indoor/indoor unit*1	m	30/18	30/18
Connectable indoor unit ratio		%	50~130	50~130
Maximum indoor units		Piece	53	56
Connection wiring	Max. fuse current	A	80.00	90.00
	Min. wiring current	A	64.80	68.50
	Power wiring	mm ²	10+10	10+10
	Signal wiring	mm ²	2×0.75	2×0.75
Operation Range		°C	Cooling:-5~52 Heating:-27~21	Cooling:-5~52 Heating:-27~21

Nominal condition: indoor temperature (cooling): 27°C DB/19°C WB, indoor temperature (heating): 20°C DB/14.5°C WB.

Outdoor temperature(cooling): 35°C DB/24°C WB, outdoor temperature(heating): 7°C DB/6°C WB The data is measured with 7.5m equivalent pipe and 0 m height difference.

The noise level will be measured in the third octave band limited values in the semi-anechoic chamber, using a Real Time Analyser calibrated sound intensity meter. It is a sound pressure noise level.

*1 If the total pipe length is from 500 to 1000m or the height difference between the outdoor and indoor units is from 50 to 110m or the height difference between the indoor units is from 18 to 30m, you Must contact your local distributor/dealer for individual design and production.

Model			AV36NMVETA	AV38NMVETA
HP			36	38
Combination			18+18	18+20
Power supply		Ph/V/Hz	3/380~415/50/60	3/380~415/50/60
Cooling	Rated capacity	kW	100.8	106.4
	Rated capacity	kBtu/h	343.94	363.05
	Rated power input	kW	31.40	32.32
	Max. power input	kW	51.80	54.81
	Rated current	A	53.01	54.56
	Max. current	A	80.60	86.60
	EER		3.21	3.29
AEER		6.84	6.82	
Heating	Rated capacity	kw	100.8	106.4
	Rated capacity	kBtu/h	343.94	363.05
	Rated power input	kW	25.62	27.04
	Max. power input	kW	43.86	46.63
	Rated current	A	44.55	47.02
	Max. current	A	73.03	77.64
	COP		3.93	3.93
ACOP		4.31	4.34	
Compressor	Brand		MITSUBISHI ELECTRIC	MITSUBISHI ELECTRIC
	Model		ANB52FZJMT*2 +ANB52FZJMT*2	ANB52FZJMT*2 +ANB52FZJMT*2
	Type		DC INV. SCROLL	DC INV. SCROLL
	Compressor quantity		4INV	4INV
	Capacity	W	16800*2+16800*2	16800*2+16800*2
	Power Input	W	5250*2+5250*2	5250*2+5250*2
	Rated current(RLA)	A	16.5*2+16.5*2	16.5*2+16.5*2
	Speed	rps	60	60
	Crankcase Heater	W	132+132	132+132
	Refrigerant oil brand		IDEMITSUKOSAN CO.,LTD	IDEMITSUKOSAN CO.,LTD
	Refrigerant oil type		FVC68D	FVC68D
Refrigerant oil charge	ml	(2300+1500)*2 +(2300+1500)*2	(2300+1500)*2 +(2300+1500)*2	
Outdoor fan motor	Brand		BROAD-OCEAN	BROAD-OCEAN
	Model		(ZWK924D500002+ZWK924D500002)+(ZWK924D500002+ZWK924D500002)	(ZWK924D500002+ZWK924D500002)+(ZWK924D500002+ZWK924D500002)
	Voltage		DC540V	DC540V
	IP Class		IP44	IP44
	Type/quantity		DC/2+DC/2	DC/2+DC/2
	Insulation class		B	B
	Safe class		I	I
	Power Input	W	2320+2320	2320+2320
	Output	W	1800+1800	1800+1800
	Rated current	A	8+8	8+8
	Capacitor	μF	/	/
Speed	rpm	0~1180	0~1180	

Model			AV36NMVETA	AV38NMVETA	
Outdoor fan	Brand		Tian Da+Tian Da	Tian Da+Tian Da	
	Model		/	/	
	Material		ABS+20%GF	ABS+20%GF	
	Type		Axial	Axial	
	Diameter	mm	Φ642+Φ642	Φ642+Φ642	
	Height	mm	198+198	198+198	
Outdoor coil	Number of rows		3+3	3+3	
	Tube pitch(a)x row pitch(b)	mm	21×18.186	21×18.186	
	Fin spacing	mm	1.6	1.6	
	Fin type(code)		Hydrophilic aluminum	Hydrophilic aluminum	
	Fin coating Type	Optional	Clear lacquer	Clear lacquer	
	Salt Spray Test Duration	Hour	168	168	
	Tube outside dia.and type	mm		INNERGROOVE TUBE	INNERGROOVE TUBE
				Φ7	Φ7
Coil length x height	mm	(2843*1260+2757*1260+2669*1260)+(2843*1260+2757*1260+2669*1260)	(2843*1260+2757*1260+2669*1260)+(2843*1260+2757*1260+2669*1260)		
Number or circuits		29	29		
Cabinet coating	Coating type		Powerr Coating	Powerr Coating	
	Salt Spray Test Duration	Hour	72	72	
	Sheet Metal Material		Hot zinc plate	Hot zinc plate	
	Sheet Metal Thickness	mm	1	1	
Control panel enclosure IP class	standard		IP24	IP24	
Outdoor air flow (cooling/heating)	m ³ /h		34000	34000	
External static pressure	Pa		110	110	
Outdoor sound level(sound power level) (H)	dB(A)		91	91	
Outdoor unit	Dimension(W*D*H)	mm	1410/750/1690	1410/750/1690	
			+1410/750/1690	+1410/750/1690	
	Packing(W*D*H)	mm	1515/850/1858	1515/850/1858	
			+1515/850/1858	+1515/850/1858	
Net weight	kg	385+385	385+385		
Gross weight	kg	410+410	410+410		
Refrigerant	Type		R410A	R410A	
	Charged volume	kg	20	20	
Throttle type			EXV	EXV	
Design pressure	Mpa		4.15	4.15	

Model			AV36NMVETA	AV38NMVETA
Frigerant piping	Liquid pipe	mm	19.05	19.05
	Gas pipe	mm	38.1	38.1
	Oil pipe	mm	/	/
	Total pipe length	m	1000	1000
	Max. pipe length(Equivalent/Actual)	m	260/220	260/220
	Max. Diff. indoor/outdoor unit*1	m	110/90	110/90
	Standard Diff. indoor/outdoor unit	m	50/40	50/40
	Max./standard Diff. indoor/indoor unit*1	m	30/18	30/18
Connectable indoor unit ratio		%	50~130	50~130
Maximum indoor units		Piece	59	63
Connection wiring	Max. fuse current	A	100.00	100.00
	Min. wiring current	A	72.20	78.50
	Power wiring	mm ²	10+10	10+16
	Signal wiring	mm ²	2×0.75	2×0.75
Operation Range		°C	Cooling:-5~52 Heating:-27~21	Cooling:-5~52 Heating:-27~21

Nominal condition: indoor temperature (cooling): 27°C DB/19°C WB, indoor temperature (heating): 20°C DB/14.5°C WB.

Outdoor temperature(cooling): 35°C DB/24°C WB, outdoor temperature(heating): 7°C DB/6°C WB The data is measured with 7.5m equivalent pipe and 0 m height difference.

The noise level will be measured in the third octave band limited values in the semi-anechoic chamber, using a Real Time Analyser calibrated sound intensity meter. It is a sound pressure noise level.

*1 If the total pipe length is from 500 to 1000m or the height difference between the outdoor and indoor units is from 50 to 110m or the height difference between the indoor units is from 18 to 30m, you Must contact your local distributor/dealer for individual design and production.

Model			AV40NMVETA	AV42NMVETA
HP			40	42
Combination			20+20	20+22
Power supply		Ph/V/Hz	3/380~415/50/60	3/380~415/50/60
Cooling	Rated capacity	kW	112.0	117.5
	Rated capacity	kBtu/h	382.16	400.93
	Rated power input	kW	33.23	34.92
	Max. power input	kW	57.82	60.73
	Rated current	A	56.11	58.95
	Max. current	A	92.60	98.21
	EER		3.37	3.36
	AEER		6.80	6.69
Heating	Rated capacity	kw	112.0	117.5
	Rated capacity	kBtu/h	382.16	400.93
	Rated power input	kW	28.47	30.37
	Max. power input	kW	49.40	50.39
	Rated current	A	49.50	52.81
	Max. current	A	82.25	83.90
	COP		3.93	3.86
	ACOP		4.38	4.38
Compressor	Brand		MITSUBISHI ELECTRIC	MITSUBISHI ELECTRIC
	Model		ANB52FZJMT*2 +ANB52FZJMT*2	ANB52FZJMT*2 +ANB66FZXMT*2*2
	Type		DC INV. SCROLL	DC INV. SCROLL
	Compressor quantity		4INV	4INV
	Capacity	W	16800*2+16800*2	16800*2+21300*2
	Power Input	W	5250*2+5250*2	5250*2+6650*2
	Rated current(RLA)	A	16.5*2+16.5*2	16.5*2+21.5*2
	Speed	rps	60	60
	Crankcase Heater	W	132+132	132+132
	Refrigerant oil brand		IDEMITSUKOSAN CO.,LTD	IDEMITSUKOSAN CO.,LTD
	Refrigerant oil type		FVC68D	FVC68D
Refrigerant oil charge	ml	(2300+1500)*2 +(2300+1500)*2	(2300+1500)*2 +(2300+1500)*2	
Outdoor fan motor	Brand		BROAD-OCEAN	BROAD-OCEAN
	Model		(ZWK924D500002 +ZWK924D500002) +(ZWK924D500002 +ZWK924D500002)	(ZWK924D500002 +ZWK924D500002) +(ZWK924D500002 +ZWK924D500002)
	Voltage		DC540V	DC540V
	IP Class		IP44	IP44
	Type/quantity		DC/2+DC/2	DC/2+DC/2
	Insulation class		B	B
	Safe class		I	I
	Power Input	W	2320+2320	2320+2320
	Output	W	1800+1800	1800+1800
	Rated current	A	8+8	8+8
	Capacitor	μF	/	/
Speed	rpm	0~1180	0~1180	

Model			AV40NMVETA	AV42NMVETA	
Outdoor fan	Brand		Tian Da+Tian Da	Tian Da+Tian Da	
	Model		/	/	
	Material		ABS+20%GF	ABS+20%GF	
	Type		Axial	Axial	
	Diameter	mm	Φ642+Φ642	Φ642+Φ642	
	Height	mm	198+198	198+198	
Outdoor coil	Number of rows		3+3	3+3	
	Tube pitch(a)x row pitch(b)	mm	21×18.186	21×18.186	
	Fin spacing	mm	1.6	1.6	
	Fin type(code)		Hydrophilic aluminum	Hydrophilic aluminum	
	Fin coating Type	Optional	Clear lacquer	Clear lacquer	
	Salt Spray Test Duration	Hour	168	168	
	Tube outside dia.and type	mm		INNERGROOVE TUBE	INNERGROOVE TUBE
				Φ7	Φ7
Coil length x height	mm	(2843*1260+2757*1260+2669*1260)+(2843*1260+2757*1260+2669*1260)	(2843*1260+2757*1260+2669*1260)+(2843*1260+2757*1260+2669*1260)		
Number or circuits		29	29		
Cabinet coating	Coating type		Power Coating	Power Coating	
	Salt Spray Test Duration	Hour	72	72	
	Sheet Metal Material		Hot zinc plate	Hot zinc plate	
	Sheet Metal Thickness	mm	1	1	
Control panel enclosure IP class	standard		IP24	IP24	
Outdoor air flow (cooling/heating)	m ³ /h		34000	35000	
External static pressure	Pa		110	110	
Outdoor sound level(sound power level) (H)	dB(A)		91	92	
Outdoor unit	Dimension(W*D*H)	mm	1410/750/1690	1410/750/1690	
			+1410/750/1690	+1410/750/1690	
	Packing(W*D*H)	mm	1515/850/1858	1515/850/1858	
			+1515/850/1858	+1515/850/1858	
Net weight	kg	385+385	385+385		
Gross weight	kg	410+410	410+410		
Refrigerant	Type		R410A	R410A	
	Charged volume	kg	20	20	
Throttle type			EXV	EXV	
Design pressure	Mpa		4.15	4.15	

Model			AV40NMVETA	AV42NMVETA
Frigerant piping	Liquid pipe	mm	19.05	19.05
	Gas pipe	mm	38.1	38.1
	Oil pipe	mm	/	/
	Total pipe length	m	1000	1000
	Max. pipe length(Equivalent/Actual)	m	260/220	260/220
	Max. Diff. indoor/outdoor unit*1	m	110/90	110/90
	Standard Diff. indoor/outdoor unit	m	50/40	50/40
	Max./standard Diff. indoor/indoor unit*1	m	30/18	30/18
Connectable indoor unit ratio		%	50~130	50~130
Maximum indoor units		Piece	64	64
Connection wiring	Max. fuse current	A	100.00	113.00
	Min. wiring current	A	84.80	90.50
	Power wiring	mm ²	16+16	16+16
	Signal wiring	mm ²	2×0.75	2×0.75
Operation Range		°C	Cooling:-5~52 Heating:-27~21	Cooling:-5~52 Heating:-27~21

Nominal condition: indoor temperature (cooling): 27°C DB/19°C WB, indoor temperature (heating): 20°C DB/14.5°C WB.

Outdoor temperature(cooling): 35°C DB/24°C WB, outdoor temperature(heating): 7°C DB/6°C WB The data is measured with 7.5m equivalent pipe and 0 m height difference.

The noise level will be measured in the third octave band limited values in the semi-anechoic chamber, using a Real Time Analyser calibrated sound intensity meter. It is a sound pressure noise level.

*1 If the total pipe length is from 500 to 1000m or the height difference between the outdoor and indoor units is from 50 to 110m or the height difference between the indoor units is from 18 to 30m, you Must contact your local distributor/dealer for individual design and production.

Model			AV44NMVETA	AV46NMVETA
HP			44	46
Combination			22+22	22+24
Power supply		Ph/V/Hz	3/380~415/50/60	3/380~415/50/60
Cooling	Rated capacity	kW	123.0	129.5
	Rated capacity	kBtu/h	419.69	441.87
	Rated power input	kW	36.61	36.91
	Max. power input	kW	63.64	64.63
	Rated current	A	61.80	62.32
	Max. current	A	103.82	106.03
	EER		3.36	3.51
	AEER		6.59	6.76
Heating	Rated capacity	kw	123.0	129.5
	Rated capacity	kBtu/h	419.69	441.87
	Rated power input	kW	32.27	35.00
	Max. power input	kW	51.38	56.09
	Rated current	A	56.12	60.86
	Max. current	A	85.55	93.39
	COP		3.81	3.69
	ACOP		4.39	4.36
Compressor	Brand		MITSUBISHI ELECTRIC	MITSUBISHI ELECTRIC
	Model		ANB66FZXMT*2 +ANB66FZXMT*2	ANB66FZXMT*2 +ANB66FZXMT*2
	Type		DC INV. SCROLL	DC INV. SCROLL
	Compressor quantity		4INV	4INV
	Capacity	W	21300*2+21300*2	21300*2+21300*2
	Power Input	W	6600*2+6600*2	6600*2+6600*2
	Rated current(RLA)	A	21.5*2+21.5*2	21.5*2+21.5*2
	Speed	rps	60	60
	Crankcase Heater	W	132+132	132+132
	Refrigerant oil brand		IDEMITSUKOSAN CO.,LTD	IDEMITSUKOSAN CO.,LTD
	Refrigerant oil type		FVC68D	FVC68D
Refrigerant oil charge	ml	(2300+1500)*2 +(2300+1500)*2	(2300+1500)*2 +(2300+1500)*2	
Outdoor fan motor	Brand		BROAD-OCEAN	BROAD-OCEAN
	Model		(ZWK924D500002 +ZWK924D500002) +(ZWK924D500002 +ZWK924D500002)	(ZWK924D500002 +ZWK924D500002) +(ZWK924D500002 +ZWK924D500002)
	Voltage		DC540V	DC540V
	IP Class		IP44	IP44
	Type/quantity		DC/2+DC/2	DC/2+DC/2
	Insulation class		B	B
	Safe class		I	I
	Power Input	W	2320+2320	2320+2320
	Output	W	1800+1800	1800+1800
	Rated current	A	8+8	8+8
	Capacitor	μF	/	/
Speed	rpm	0~1180	0~1180	

Model			AV44NMVETA	AV46NMVETA	
Outdoor fan	Brand		Tian Da+Tian Da	Tian Da+Tian Da	
	Model		/	/	
	Material		ABS+20%GF	ABS+20%GF	
	Type		Axial	Axial	
	Diameter	mm	Φ642+Φ642	Φ642+Φ642	
	Height	mm	198+198	198+198	
Outdoor coil	Number of rows		3+3	3+3	
	Tube pitch(a)x row pitch(b)	mm	21×18.186	21×18.186	
	Fin spacing	mm	1.6	1.6	
	Fin type(code)		Hydrophilic aluminum	Hydrophilic aluminum	
	Fin coating Type	Optional	Clear lacquer	Clear lacquer	
	Salt Spray Test Duration	Hour	168	168	
	Tube outside dia.and type	mm		INNERGROOVE TUBE	INNERGROOVE TUBE
				Φ7	Φ7
Coil length x height	mm	(2843*1260+2757*1260+2669*1260)+(2843*1260+2757*1260+2669*1260)	(2843*1260+2757*1260+2669*1260)+(2843*1260+2757*1260+2669*1260)		
Number or circuits		29	29		
Cabinet coating	Coating type		Powerr Coating	Powerr Coating	
	Salt Spray Test Duration	Hour	72	72	
	Sheet Metal Material		Hot zinc plate	Hot zinc plate	
	Sheet Metal Thickness	mm	1	1	
Control panel enclosure IP class	standard		IP24	IP24	
Outdoor air flow (cooling/heating)	m ³ /h		36000	36000	
External static pressure	Pa		110	110	
Outdoor sound level(sound power level) (H)	dB(A)		93	93	
Outdoor unit	Dimension(W*D*H)	mm	1410/750/1690	1410/750/1690	
			+1410/750/1690	+1410/750/1690	
	Packing(W*D*H)	mm	1515/850/1858	1515/850/1858	
			+1515/850/1858	+1515/850/1858	
Net weight	kg	385+385	385+385		
Gross weight	kg	410+410	410+410		
Refrigerant	Type		R410A	R410A	
	Charged volume	kg	20	20	
Throttle type			EXV	EXV	
Design pressure	Mpa		4.15	4.15	

Model			AV44NMVETA	AV46NMVETA
Frigerant piping	Liquid pipe	mm	19.05	19.05
	Gas pipe	mm	38.1	38.1
	Oil pipe	mm	/	/
	Total pipe length	m	1000	1000
	Max. pipe length(Equivalent/Actual)	m	260/220	260/220
	Max. Diff. indoor/outdoor unit*1	m	110/90	110/90
	Standard Diff. indoor/outdoor unit	m	50/40	50/40
	Max./standard Diff. indoor/indoor unit*1	m	30/18	30/18
Connectable indoor unit ratio		%	50~130	50~130
Maximum indoor units		Piece	64	64
Connection wiring	Max. fuse current	A	126.00	126.00
	Min. wiring current	A	96.20	97.20
	Power wiring	mm ²	16+16	16+25
	Signal wiring	mm ²	2×0.75	2×0.75
Operation Range		°C	Cooling:-5~52 Heating:-27~21	Cooling:-5~52 Heating:-27~21

Nominal condition: indoor temperature (cooling): 27°C DB/19°C WB, indoor temperature (heating): 20°C DB/14.5°C WB.

Outdoor temperature(cooling): 35°C DB/24°C WB, outdoor temperature(heating): 7°C DB/6°C WB The data is measured with 7.5m equivalent pipe and 0 m height difference.

The noise level will be measured in the third octave band limited values in the semi-anechoic chamber, using a Real Time Analyser calibrated sound intensity meter. It is a sound pressure noise level.

*1 If the total pipe length is from 500 to 1000m or the height difference between the outdoor and indoor units is from 50 to 110m or the height difference between the indoor units is from 18 to 30m, you Must contact your local distributor/dealer for individual design and production.

Model			AV48NMVETA	AV50NMVETA
HP			48	50
Combination			24+24	24+26
Power supply		Ph/V/Hz	3/380~415/50/60	3/380~415/50/60
Cooling	Rated capacity	kW	136.0	141.5
	Rated capacity	kBtu/h	464.05	482.82
	Rated power input	kW	37.22	39.86
	Max. power input	kW	65.62	68.16
	Rated current	A	62.84	67.29
	Max. current	A	108.24	112.98
	EER		3.65	3.55
	AEER		6.97	6.87
Heating	Rated capacity	kw	136.0	141.5
	Rated capacity	kBtu/h	464.05	482.82
	Rated power input	kW	37.73	40.49
	Max. power input	kW	60.80	62.85
	Rated current	A	65.60	70.40
	Max. current	A	101.23	104.65
	COP		3.60	3.49
	ACOP		4.34	4.08
Compressor	Brand		MITSUBISHI ELECTRIC	MITSUBISHI ELECTRIC
	Model		ANB66FZXMT*2 +ANB66FZXMT*2	ANB66FZXMT*2 +ANB78FZXMT*2
	Type		DC INV. SCROLL	DC INV. SCROLL
	Compressor quantity		4INV	4INV
	Capacity	W	21300*2+21300*2	21300*2+25200*2
	Power Input	W	6600*2+6600*2	6600*2+7700*2
	Rated current(RLA)	A	21.5*2+21.5*2	21.5*2+26*2
	Speed	rps	60	60
	Crankcase Heater	W	132+132	132+132
	Refrigerant oil brand		IDEMITSUKOSAN CO.,LTD	IDEMITSUKOSAN CO.,LTD
	Refrigerant oil type		FVC68D	FVC68D
Refrigerant oil charge	ml	(2300+1500)*2 +(2300+1500)*2	(2300+1500)*2 +(2300+1500)*2	
Outdoor fan motor	Brand		BROAD-OCEAN	BROAD-OCEAN
	Model		(ZWK924D500002 +ZWK924D500002) +(ZWK924D500002 +ZWK924D500002)	(ZWK924D500002 +ZWK924D500002) +(ZWK924D500002 +ZWK924D500002)
	Voltage		DC540V	DC540V
	IP Class		IP44	IP44
	Type/quantity		DC/2+DC/2	DC/2+DC/2
	Insulation class		B	B
	Safe class		I	I
	Power Input	W	2320+2320	2320+2320
	Output	W	1800+1800	1800+1800
	Rated current	A	8+8	8+8
	Capacitor	μF	/	/
Speed	rpm	0~1180	0~1180	

Model			AV48NMVETA	AV50NMVETA	
Outdoor fan	Brand		Tian Da+Tian Da	Tian Da+Tian Da	
	Model		/	/	
	Material		ABS+20%GF	ABS+20%GF	
	Type		Axial	Axial	
	Diameter	mm	Φ642+Φ642	Φ642+Φ642	
	Height	mm	198+198	198+198	
Outdoor coil	Number of rows		3+3	3+3	
	Tube pitch(a)x row pitch(b)	mm	21×18.186	21×18.186	
	Fin spacing	mm	1.6	1.6	
	Fin type(code)		Hydrophilic aluminum	Hydrophilic aluminum	
	Fin coating Type	Optional	Clear lacquer	Clear lacquer	
	Salt Spray Test Duration	Hour	168	168	
	Tube outside dia.and type	mm		INNERGROOVE TUBE	INNERGROOVE TUBE
				Φ7	Φ7
Coil length x height	mm	(2843*1260+2757*1260+2669*1260)+(2843*1260+2757*1260+2669*1260)	(2843*1260+2757*1260+2669*1260)+(2843*1260+2757*1260+2669*1260)		
Number or circuits		29	29		
Cabinet coating	Coating type		Powerr Coating	Powerr Coating	
	Salt Spray Test Duration	Hour	72	72	
	Sheet Metal Material		Hot zinc plate	Hot zinc plate	
	Sheet Metal Thickness	mm	1	1	
Control panel enclosure IP class	standard		IP24	IP24	
Outdoor air flow (cooling/heating)	m ³ /h		36000	37000	
External static pressure	Pa		110	110	
Outdoor sound level(sound power level) (H)	dB(A)		93	93	
Outdoor unit	Dimension(W*D*H)	mm	1410/750/1690	1410/750/1690	
			+1410/750/1690	+1410/750/1690	
	Packing(W*D*H)	mm	1515/850/1858	1515/850/1858	
			+1515/850/1858	+1515/850/1858	
Net weight	kg	385+385	385+385		
Gross weight	kg	410+410	410+410		
Refrigerant	Type		R410A	R410A	
	Charged volume	kg	20	20	
Throttle type			EXV	EXV	
Design pressure	Mpa		4.15	4.15	

Model			AV48NMVETA	AV50NMVETA
Frigerant piping	Liquid pipe	mm	19.05	19.05
	Gas pipe	mm	38.1	38.1
	Oil pipe	mm	/	/
	Total pipe length	m	1000	1000
	Max. pipe length(Equivalent/Actual)	m	260/220	260/220
	Max. Diff. indoor/outdoor unit*1	m	110/90	110/90
	Standard Diff. indoor/outdoor unit	m	50/40	50/40
	Max./standard Diff. indoor/indoor unit*1	m	30/18	30/18
Connectable indoor unit ratio		%	50~130	50~130
Maximum indoor units		Piece	64	64
Connection wiring	Max. fuse current	A	126.00	126.00
	Min. wiring current	A	98.20	104.90
	Power wiring	mm ²	25+25	25+25
	Signal wiring	mm ²	2×0.75	2×0.75
Operation Range		°C	Cooling:-5~52 Heating:-27~21	Cooling:-5~52 Heating:-27~21

Nominal condition: indoor temperature (cooling): 27°C DB/19°C WB, indoor temperature (heating): 20°C DB/14.5°C WB.

Outdoor temperature(cooling): 35°C DB/24°C WB, outdoor temperature(heating): 7°C DB/6°C WB The data is measured with 7.5m equivalent pipe and 0 m height difference.

The noise level will be measured in the third octave band limited values in the semi-anechoic chamber, using a Real Time Analyser calibrated sound intensity meter. It is a sound pressure noise level.

*1 If the total pipe length is from 500 to 1000m or the height difference between the outdoor and indoor units is from 50 to 110m or the height difference between the indoor units is from 18 to 30m, you Must contact your local distributor/dealer for individual design and production.

Model			AV52NMVETA	AV54NMVETA
HP			52	54
Combination			26+26	18+18+18
Power supply		Ph/V/Hz	3/380~415/50/60	3/380~415/50/60
Cooling	Rated capacity	kW	147.0	151.2
	Rated capacity	kBtu/h	501.58	515.92
	Rated power input	kW	42.49	47.10
	Max. power input	kW	70.70	77.70
	Rated current	A	71.73	79.52
	Max. current	A	117.72	120.90
	EER		3.46	3.21
	AEER		6.78	6.85
Heating	Rated capacity	kw	147.0	151.2
	Rated capacity	kBtu/h	501.58	515.92
	Rated power input	kW	43.25	38.43
	Max. power input	kW	64.90	65.79
	Rated current	A	75.20	66.82
	Max. current	A	108.06	109.54
	COP		3.39	3.93
	ACOP		3.88	4.31
Compressor	Brand		MITSUBISHI ELECTRIC	MITSUBISHI ELECTRIC
	Model		ANB78FZXMT*2 +ANB78FZXMT*2	ANB52FZJMT*2 +ANB52FZJMT*2 +ANB52FZJMT*2
	Type		DC INV. SCROLL	DC INV. SCROLL
	Compressor quantity		4INV	6INV
	Capacity	W	25200*2+25200*2	16800*2+16800*2+16800*2
	Power Input	W	7700*2+7700*2	5250*2+5250*2+5250*2
	Rated current(RLA)	A	26*2+26*2	16.5*2+16.5*2+16.5*2
	Speed	rps	60	60
	Crankcase Heater	W	132+132	132+132+132
	Refrigerant oil brand		IDEMITSUKOSAN CO.,LTD	IDEMITSUKOSAN CO.,LTD
	Refrigerant oil type		FVC68D	FVC68D
Refrigerant oil charge	ml	(2300+1500)*2 +(2300+1500)*2	(2300+1500)*2 +(2300+1500)*2 +(2300+1500)*2	
Outdoor fan motor	Brand		BROAD-OCEAN	BROAD-OCEAN
	Model		(ZWK924D500002 +ZWK924D500002) +(ZWK924D500002 +ZWK924D500002)	(ZWK924D500002 +ZWK924D500002)*3
	Voltage		DC540V	DC540V
	IP Class		IP44	IP44
	Type/quantity		DC/2+DC/2	DC/2+DC/2+DC/2
	Insulation class		B	B
	Safe class		I	I
	Power Input	W	2320+2320	2320+2320+2320
	Output	W	1800+1800	1800+1800+1800
	Rated current	A	8+8	8+8+8
	Capacitor	μF	/	/
Speed	rpm	0~1180	0~1180	

Model			AV52NMVETA	AV54NMVETA	
Outdoor fan	Brand		Tian Da+Tian Da	Tian Da+Tian Da+Tian Da	
	Model		/	/	
	Material		ABS+20%GF	ABS+20%GF	
	Type		Axial	Axial	
	Diameter	mm	Φ642+Φ642	Φ642+Φ642+Φ642+Φ642	
	Height	mm	198+198	198+198+198	
Outdoor coil	Number of rows		3+3	3+3+3	
	Tube pitch(a)x row pitch(b)	mm	21×18.186	21×18.186	
	Fin spacing	mm	1.6	1.6	
	Fin type(code)		Hydrophilic aluminum	Hydrophilic aluminum	
	Fin coating Type	Optional	Clear lacquer	Clear lacquer	
	Salt Spray Test Duration	Hour	168	168	
	Tube outside dia.and type	mm		INNERGROOVE TUBE	INNERGROOVE TUBE
				Φ7	Φ7
Coil length x height	mm	(2843*1260+2757*1260+2669*1260)+(2843*1260+2757*1260+2669*1260)	(2843*1260+2757*1260+2669*1260)+(2843*1260+2757*1260+2669*1260)		
Number or circuits		29	29		
Cabinet coating	Coating type		Powerr Coating	Powerr Coating	
	Salt Spray Test Duration	Hour	72	72	
	Sheet Metal Material		Hot zinc plate	Hot zinc plate	
	Sheet Metal Thickness	mm	1	1	
Control panel enclosure IP class	standard		IP24	IP24	
Outdoor air flow (cooling/heating)	m ³ /h		38000	51000	
External static pressure	Pa		110	110	
Outdoor sound level(sound power level) (H)	dB(A)		93	93	
Outdoor unit	Dimension(W*D*H)	mm	1410/750/1690 +1410/750/1690	1410/750/1690+1410/750/1690 690+1410/750/1690	
			1515/850/1858 +1515/850/1858	1515/850/1858+1515/850/1858 858+1515/850/1858	
	Net weight	kg	385+385	385+385+385	
	Gross weight	kg	410+410	410+410+410	
Refrigerant	Type		R410A	R410A	
	Charged volume	kg	20	30	
Throttle type			EXV	EXV	
Design pressure	Mpa		4.15	4.15	

Model			AV52NMVETA	AV54NMVETA
Frigerant piping	Liquid pipe	mm	19.05	19.05
	Gas pipe	mm	38.1	38.1
	Oil pipe	mm	/	/
	Total pipe length	m	1000	1000
	Max. pipe length(Equivalent/Actual)	m	260/220	260/220
	Max. Diff. indoor/outdoor unit*1	m	110/90	110/90
	Standard Diff. indoor/outdoor unit	m	50/40	50/40
	Max./standard Diff. indoor/indoor unit*1	m	30/18	30/18
Connectable indoor unit ratio		%	50~130	50~130
Maximum indoor units		Piece	64	64
Connection wiring	Max. fuse current	A	126.00	150.00
	Min. wiring current	A	111.60	108.30
	Power wiring	mm ²	25+25	10+10+10
	Signal wiring	mm ²	2×0.75	2×0.75
Operation Range		°C	Cooling:-5~52 Heating:-27~21	Cooling:-5~52 Heating:-27~21

Nominal condition: indoor temperature (cooling): 27°C DB/19°C WB, indoor temperature (heating): 20°C DB/14.5°C WB.

Outdoor temperature(cooling): 35°C DB/24°C WB, outdoor temperature(heating): 7°C DB/6°C WB The data is measured with 7.5m equivalent pipe and 0 m height difference.

The noise level will be measured in the third octave band limited values in the semi-anechoic chamber, using a Real Time Analyser calibrated sound intensity meter. It is a sound pressure noise level.

*1 If the total pipe length is from 500 to 1000m or the height difference between the outdoor and indoor units is from 50 to 110m or the height difference between the indoor units is from 18 to 30m, you Must contact your local distributor/dealer for individual design and production.

Model			AV56NMVETA	AV58NMVETA
HP			56	58
Combination			18+18+20	18+20+20
Power supply		Ph/V/Hz	3/380~415/50/60	3/380~415/50/60
Cooling	Rated capacity	kW	156.8	162.4
	Rated capacity	kBtu/h	535.02	554.13
	Rated power input	kW	48.02	48.94
	Max. power input	kW	80.71	83.72
	Rated current	A	81.07	82.61
	Max. current	A	126.90	132.90
	EER		3.27	3.32
	AEER		6.84	6.83
Heating	Rated capacity	kw	156.8	162.4
	Rated capacity	kBtu/h	535.02	554.13
	Rated power input	kW	39.85	41.27
	Max. power input	kW	68.56	71.33
	Rated current	A	69.30	71.77
	Max. current	A	114.15	118.76
	COP		3.93	3.93
	ACOP		4.33	4.36
Compressor	Brand		MITSUBISHI ELECTRIC	MITSUBISHI ELECTRIC
	Model		ANB52FZJMT*2 +ANB52FZJMT*2 +ANB52FZJMT*2	ANB52FZJMT*2 +ANB52FZJMT*2 +ANB52FZJMT*2
	Type		DC INV. SCROLL	DC INV. SCROLL
	Compressor quantity		6INV	6INV
	Capacity	W	16800*2+16800*2+16800*2	16800*2+16800*2+16800*2
	Power Input	W	5250*2+5250*2+5250*2	5250*2+5250*2+5250*2
	Rated current(RLA)	A	16.5*2+16.5*2+16.5*2	16.5*2+16.5*2+16.5*2
	Speed	rps	60	60
	Crankcase Heater	W	132+132+132	132+132+132
	Refrigerant oil brand		IDEMITSUKOSAN CO.,LTD	IDEMITSUKOSAN CO.,LTD
	Refrigerant oil type		FVC68D	FVC68D
Refrigerant oil charge	ml	(2300+1500)*2 +(2300+1500)*2 +(2300+1500)*2	(2300+1500)*2 +(2300+1500)*2 +(2300+1500)*2	
Outdoor fan motor	Brand		BROAD-OCEAN	BROAD-OCEAN
	Model		(ZWK924D500002 +ZWK924D500002)*3	(ZWK924D500002 +ZWK924D500002)*3
	Voltage		DC540V	DC540V
	IP Class		IP44	IP44
	Type/quantity		DC/2+DC/2+DC/2	DC/2+DC/2+DC/2
	Insulation class		B	B
	Safe class		I	I
	Power Input	W	2320+2320+2320	2320+2320+2320
	Output	W	1800+1800+1800	1800+1800+1800
	Rated current	A	8+8+8	8+8+8
	Capacitor	μF	/	/
Speed	rpm	0~1180	0~1180	

Model			AV56NMVETA	AV58NMVETA
Outdoor fan	Brand		Tian Da+Tian Da+Tian Da	Tian Da+Tian Da+Tian Da
	Model		/	/
	Material		ABS+20%GF	ABS+20%GF
	Type		Axial	Axial
	Diameter	mm	Φ642+Φ642+Φ642+Φ642	Φ642+Φ642+Φ642+Φ642
	Height	mm	198+198+198	198+198+198
Outdoor coil	Number of rows		3+3+3	3+3+3
	Tube pitch(a)x row pitch(b)	mm	21×18.186	21×18.186
	Fin spacing	mm	1.6	1.6
	Fin type(code)		Hydrophilic aluminum	Hydrophilic aluminum
	Fin coating Type	Optional	Clear lacquer	Clear lacquer
	Salt Spray Test Duration	Hour	168	168
	Tube outside dia.and type	mm	INNERGROOVE TUBE Φ7	INNERGROOVE TUBE Φ7
Coil length x height	mm	(2843*1260+2757*1260 +2669*1260)+(2843*1260 +2757*1260+2669*1260) +(2843*1260+2757*1260 +2669*1260)	(2843*1260+2757*1260 +2669*1260)+(2843*1260 +2757*1260+2669*1260) +(2843*1260+2757*1260 +2669*1260)	
Number or circuits		29	29	
Cabinet coating	Coating type		Powerr Coating	Powerr Coating
	Salt Spray Test Duration	Hour	72	72
	Sheet Metal Material		Hot zinc plate	Hot zinc plate
	Sheet Metal Thickness	mm	1	1
Control panel enclosure IP class	standard	IP24	IP24	
Outdoor air flow (cooling/heating)	m ³ /h	51000	51000	
External static pressure	Pa	110	110	
Outdoor sound level(sound power level) (H)	dB(A)	93	93	
Outdoor unit	Diamension(W*D*H)	mm	1410/750/1690+1410/750/1690+1410/750/1690	1410/750/1690+1410/750/1690+1410/750/1690
	Packing(W*D*H)	mm	1515/850/1858+1515/850/1858+1515/850/1858	1515/850/1858+1515/850/1858+1515/850/1858
	Net weight	kg	385+385+385	385+385+385
	Gross weight	kg	410+410+410	410+410+410
Refrigerant	Type		R410A	R410A
	Charged volume	kg	30	30
Throttle type		EXV	EXV	
Design pressure	Mpa	4.15	4.15	

Model			AV56NMVETA	AV58NMVETA
Frigerant piping	Liquid pipe	mm	19.05	19.05
	Gas pipe	mm	38.1	41.3
	Oil pipe	mm	/	/
	Total pipe length	m	1000	1000
	Max. pipe length(Equivalent/Actual)	m	260/220	260/220
	Max. Diff. indoor/outdoor unit*1	m	110/90	110/90
	Standard Diff. indoor/outdoor unit	m	50/40	50/40
	Max./standard Diff. indoor/indoor unit*1	m	30/18	30/18
Connectable indoor unit ratio		%	50~130	50~130
Maximum indoor units		Piece	64	64
Connection wiring	Max. fuse current	A	150.00	150.00
	Min. wiring current	A	114.60	120.90
	Power wiring	mm ²	10+10+16	10+16+16
	Signal wiring	mm ²	2×0.75	2×0.75
Operation Range		°C	Cooling:-5~52 Heating:-27~21	Cooling:-5~52 Heating:-27~21

Nominal condition: indoor temperature (cooling): 27°C DB/19°C WB, indoor temperature (heating): 20°C DB/14.5°C WB.

Outdoor temperature(cooling): 35°C DB/24°C WB, outdoor temperature(heating): 7°C DB/6°C WB The data is measured with 7.5m equivalent pipe and 0 m height difference.

The noise level will be measured in the third octave band limited values in the semi-anechoic chamber, using a Real Time Analyser calibrated sound intensity meter. It is a sound pressure noise level.

*1 If the total pipe length is from 500 to 1000m or the height difference between the outdoor and indoor units is from 50 to 110m or the height difference between the indoor units is from 18 to 30m, you Must contact your local distributor/dealer for individual design and production.

Model			AV60NMVETA	AV62NMVETA
HP			60	62
Combination			20+20+20	20+20+22
Power supply		Ph/V/Hz	3/380~415/50/60	3/380~415/50/60
Cooling	Rated capacity	kW	168.0	173.5
	Rated capacity	kBtu/h	573.24	592.01
	Rated power input	kW	49.85	51.54
	Max. power input	kW	86.73	89.64
	Rated current	A	84.16	87.01
	Max. current	A	138.90	144.51
	EER		3.37	3.37
AEER		6.81	6.74	
Heating	Rated capacity	kw	168.0	173.5
	Rated capacity	kBtu/h	573.24	592.01
	Rated power input	kW	42.70	44.60
	Max. power input	kW	74.10	75.09
	Rated current	A	74.25	77.56
	Max. current	A	123.38	125.03
	COP		3.93	3.88
ACOP		4.38	4.38	
Compressor	Brand		MITSUBISHI ELECTRIC	MITSUBISHI ELECTRIC
	Model		ANB52FZJMT*2 +ANB52FZJMT*2 +ANB52FZJMT*2	ANB52FZJMT*2 +ANB52FZJMT*2 +ANB66FZXMT*2
	Type		DC INV. SCROLL	DC INV. SCROLL
	Compressor quantity		6INV	6INV
	Capacity	W	16800*2+16800*2+16800*2	16800*2+16800*2+21300*2
	Power Input	W	5250*2+5250*2+5250*2	5250*2+5250*2+6600*2
	Rated current(RLA)	A	16.5*2+16.5*2+16.5*2	16.5*2+16.5*2+21.5*2
	Speed	rps	60	60
	Crankcase Heater	W	132+132+132	132+132+132
	Refrigerant oil brand		IDEMITSUKOSAN CO.,LTD	IDEMITSUKOSAN CO.,LTD
	Refrigerant oil type		FVC68D	FVC68D
Refrigerant oil charge	ml	(2300+1500)*2+(2300+1500)*2+(2300+1500)*2	(2300+1500)*2+(2300+1500)*2+(2300+1500)*2	
Outdoor fan motor	Brand		BROAD-OCEAN	BROAD-OCEAN
	Model		(ZWK924D500002 +ZWK924D500002)*3	(ZWK924D500002 +ZWK924D500002)*3
	Voltage		DC540V	DC540V
	IP Class		IP44	IP44
	Type/quantity		DC/2+DC/2+DC/2	DC/2+DC/2+DC/2
	Insulation class		B	B
	Safe class		I	I
	Power Input	W	2320+2320+2320	2320+2320+2320
	Output	W	1800+1800+1800	1800+1800+1800
	Rated current	A	8+8+8	8+8+8
	Capacitor	μF	/	/
Speed	rpm	0~1180	0~1180	

Model			AV60NMVETA	AV62NMVETA
Outdoor fan	Brand		Tian Da+Tian Da+Tian Da	Tian Da+Tian Da+Tian Da
	Model		/	/
	Material		ABS+20%GF	ABS+20%GF
	Type		Axial	Axial
	Diameter	mm	Φ642+Φ642+Φ642+Φ642	Φ642+Φ642+Φ642+Φ642
	Height	mm	198+198+198	198+198+198
Outdoor coil	Number of rows		3+3+3	3+3+3
	Tube pitch(a)x row pitch(b)	mm	21×18.186	21×18.186
	Fin spacing	mm	1.6	1.6
	Fin type(code)		Hydrophilic aluminum	Hydrophilic aluminum
	Fin coating Type	Optional	Clear lacquer	Clear lacquer
	Salt Spray Test Duration	Hour	168	168
	Tube outside dia.and type	mm	INNERGROOVE TUBE Φ7	INNERGROOVE TUBE Φ7
Coil length x height	mm	(2843*1260+2757*1260 +2669*1260)+(2843*1260 +2757*1260+2669*1260) +(2843*1260+2757*1260 +2669*1260)	(2843*1260+2757*1260 +2669*1260)+(2843*1260+ 2757*1260+2669*1260) +(2843*1260+2757*1260 +2669*1260)	
Number or circuits		29	29	
Cabinet coating	Coating type		Powerr Coating	Powerr Coating
	Salt Spray Test Duration	Hour	72	72
	Sheet Metal Material		Hot zinc plate	Hot zinc plate
	Sheet Metal Thickness	mm	1	1
Control panel enclosure IP class	standard	IP24	IP24	
Outdoor air flow (cooling/heating)	m ³ /h	51000	52000	
External static pressure	Pa	110	110	
Outdoor sound level(sound power level) (H)	dB(A)	93	93.5	
Outdoor unit	Diamension(W*D*H)	mm	1410/750/1690+1410/750/1 690+1410/750/1690	1410/750/1690+1410/750/1 690+1410/750/1690
	Packing(W*D*H)	mm	1515/850/1858+1515/850/1 858+1515/850/1858	1515/850/1858+1515/850/1 858+1515/850/1858
	Net weight	kg	385+385+385	385+385+385
	Gross weight	kg	410+410+410	410+410+410
Refrigerant	Type		R410A	R410A
	Charged volume	kg	30	30
Throttle type		EXV	EXV	
Design pressure	Mpa	4.15	4.15	

Model			AV60NMVETA	AV62NMVETA
Frigerant piping	Liquid pipe	mm	19.05	19.05
	Gas pipe	mm	41.3	41.3
	Oil pipe	mm	/	/
	Total pipe length	m	1000	1000
	Max. pipe length(Equivalent/Actual)	m	260/220	260/220
	Max. Diff. indoor/outdoor unit*1	m	110/90	110/90
	Standard Diff. indoor/outdoor unit	m	50/40	50/40
	Max./standard Diff. indoor/indoor unit*1	m	30/18	30/18
Connectable indoor unit ratio		%	50~130	50~130
Maximum indoor units		Piece	64	64
Connection wiring	Max. fuse current	A	150.00	163.00
	Min. wiring current	A	127.20	132.90
	Power wiring	mm ²	16+16+16	16+16+16
	Signal wiring	mm ²	2×0.75	2×0.75
Operation Range		°C	Cooling:-5~52 Heating:-27~21	Cooling:-5~52 Heating:-27~21

Nominal condition: indoor temperature (cooling): 27°C DB/19°C WB, indoor temperature (heating): 20°C DB/14.5°C WB.

Outdoor temperature(cooling): 35°C DB/24°C WB, outdoor temperature(heating): 7°C DB/6°C WB The data is measured with 7.5m equivalent pipe and 0 m height difference.

The noise level will be measured in the third octave band limited values in the semi-anechoic chamber, using a Real Time Analyser calibrated sound intensity meter. It is a sound pressure noise level.

*1 If the total pipe length is from 500 to 1000m or the height difference between the outdoor and indoor units is from 50 to 110m or the height difference between the indoor units is from 18 to 30m, you Must contact your local distributor/dealer for individual design and production.

Model			AV64NMVETA	AV66NMVETA
HP			64	66
Combination			20+22+22	22+22+22
Power supply		Ph/V/Hz	3/380~415/50/60	3/380~415/50/60
Cooling	Rated capacity	kW	179.0	184.5
	Rated capacity	kBtu/h	610.77	629.54
	Rated power input	kW	53.22	54.91
	Max. power input	kW	92.55	95.46
	Rated current	A	89.85	92.70
	Max. current	A	150.12	155.73
	EER		3.36	3.36
	AEER		6.67	6.60
Heating	Rated capacity	kw	179.0	184.5
	Rated capacity	kBtu/h	610.77	629.54
	Rated power input	kW	46.51	48.41
	Max. power input	kW	76.08	77.08
	Rated current	A	80.87	84.18
	Max. current	A	126.68	128.33
	COP		3.84	3.81
	ACOP		4.39	4.39
Compressor	Brand		MITSUBISHI ELECTRIC	MITSUBISHI ELECTRIC
	Model		ANB52FZJMT*2+ANB66FZXMT*2+ANB66FZXMT*2	ANB66FZXMT*2+ANB66FZXMT*2
	Type		DC INV. SCROLL	DC INV. SCROLL
	Compressor quantity		6INV	6INV
	Capacity	W	16800*2+21300*2+21300*2	21300*2+21300*2+21300*2
	Power Input	W	5250*2+6600*2+6600*2	6600*2+6600*2+6600*2
	Rated current(RLA)	A	16.5*2+21.5*2+21.5*2	21.5*2+21.5*2+21.5*2
	Speed	rps	60	60
	Crankcase Heater	W	132+132+132	132+132+132
	Refrigerant oil brand		IDEMITSUKOSAN CO.,LTD	IDEMITSUKOSAN CO.,LTD
	Refrigerant oil type		FVC68D	FVC68D
Refrigerant oil charge	ml	(2300+1500)*2 +(2300+1500)*2 +(2300+1500)*2	(2300+1500)*2 +(2300+1500)*2 +(2300+1500)*2	
Outdoor fan motor	Brand		BROAD-OCEAN	BROAD-OCEAN
	Model		(ZWK924D500002 +ZWK924D500002)*3	(ZWK924D500002 +ZWK924D500002)*3
	Voltage		DC540V	DC540V
	IP Class		IP44	IP44
	Type/quantity		DC/2+DC/2+DC/2	DC/2+DC/2+DC/2
	Insulation class		B	B
	Safe class		I	I
	Power Input	W	2320+2320+2320	2320+2320+2320
	Output	W	1800+1800+1800	1800+1800+1800
	Rated current	A	8+8+8	8+8+8
	Capacitor	μF	/	/
Speed	rpm	0~1180	0~1180	

Model			AV64NMVETA	AV66NMVETA
Outdoor fan	Brand		Tian Da+Tian Da+Tian Da	Tian Da+Tian Da+Tian Da
	Model		/	/
	Material		ABS+20%GF	ABS+20%GF
	Type		Axial	Axial
	Diameter	mm	Φ642+Φ642+Φ642+Φ642	Φ642+Φ642+Φ642+Φ642
	Height	mm	198+198+198	198+198+198
Outdoor coil	Number of rows		3+3+3	3+3+3
	Tube pitch(a)x row pitch(b)	mm	21×18.186	21×18.186
	Fin spacing	mm	1.6	1.6
	Fin type(code)		Hydrophilic aluminum	Hydrophilic aluminum
	Fin coating Type	Optional	Clear lacquer	Clear lacquer
	Salt Spray Test Duration	Hour	168	168
	Tube outside dia.and type	mm	INNERGROOVE TUBE Φ7	INNERGROOVE TUBE Φ7
Coil length x height	mm	(2843*1260+2757*1260+2669*1260)+(2843*1260+2757*1260+2669*1260) +(2843*1260+2757*1260+2669*1260)	(2843*1260+2757*1260+2669*1260)+(2843*1260+2757*1260+2669*1260) +(2843*1260+2757*1260+2669*1260)	
Number or circuits		29	29	
Cabinet coating	Coating type		Powerr Coating	Powerr Coating
	Salt Spray Test Duration	Hour	72	72
	Sheet Metal Material		Hot zinc plate	Hot zinc plate
	Sheet Metal Thickness	mm	1	1
Control panel enclosure IP class	standard	IP24	IP24	
Outdoor air flow (cooling/heating)	m ³ /h	53000	54000	
External static pressure	Pa	110	110	
Outdoor sound level(sound power level) (H)	dB(A)	94	95	
Outdoor unit	Diamension(W*D*H)	mm	1410/750/1690+1410/750/1690+1410/750/1690	1410/750/1690+1410/750/1690+1410/750/1690
	Packing(W*D*H)	mm	1515/850/1858+1515/850/1858+1515/850/1858	1515/850/1858+1515/850/1858+1515/850/1858
	Net weight	kg	385+385+385	385+385+385
	Gross weight	kg	410+410+410	410+410+410
Refrigerant	Type		R410A	R410A
	Charged volume	kg	30	30
Throttle type		EXV	EXV	
Design pressure	Mpa	4.15	4.15	

Model			AV64NMVETA	AV66NMVETA
Frigerant piping	Liquid pipe	mm	19.05	19.05
	Gas pipe	mm	41.3	41.3
	Oil pipe	mm	/	/
	Total pipe length	m	1000	1000
	Max. pipe length(Equivalent/Actual)	m	260/220	260/220
	Max. Diff. indoor/outdoor unit*1	m	110/90	110/90
	Standard Diff. indoor/outdoor unit	m	50/40	50/40
	Max./standard Diff. indoor/indoor unit*1	m	30/18	30/18
Connectable indoor unit ratio		%	50~130	50~130
Maximum indoor units		Piece	64	64
Connection wiring	Max. fuse current	A	176.00	189.00
	Min. wiring current	A	138.60	144.30
	Power wiring	mm ²	16+16+16	16+16+16
	Signal wiring	mm ²	2×0.75	2×0.75
Operation Range		°C	Cooling:-5~52 Heating:-27~21	Cooling:-5~52 Heating:-27~21

Nominal condition: indoor temperature (cooling): 27°C DB/19°C WB, indoor temperature (heating): 20°C DB/14.5°C WB.

Outdoor temperature(cooling): 35°C DB/24°C WB, outdoor temperature(heating): 7°C DB/6°C WB The data is measured with 7.5m equivalent pipe and 0 m height difference.

The noise level will be measured in the third octave band limited values in the semi-anechoic chamber, using a Real Time Analyser calibrated sound intensity meter. It is a sound pressure noise level.

*1 If the total pipe length is from 500 to 1000m or the height difference between the outdoor and indoor units is from 50 to 110m or the height difference between the indoor units is from 18 to 30m, you Must contact your local distributor/dealer for individual design and production.

Model			AV68NMVETA	AV70NMVETA
HP			68	70
Combination			22+22+24	22+24+24
Power supply		Ph/V/Hz	3/380~415/50/60	3/380~415/50/60
Cooling	Rated capacity	kW	191.0	197.5
	Rated capacity	kBtu/h	651.72	673.90
	Rated power input	kW	55.22	55.53
	Max. power input	kW	96.45	97.44
	Rated current	A	93.22	93.74
	Max. current	A	157.94	160.15
	EER		3.46	3.56
	AEER		6.80	6.86
Heating	Rated capacity	kw	191.0	197.5
	Rated capacity	kBtu/h	651.72	673.90
	Rated power input	kW	51.14	53.86
	Max. power input	kW	81.78	86.49
	Rated current	A	88.92	93.66
	Max. current	A	136.17	144.01
	COP		3.73	3.66
	ACOP		4.37	4.35
Compressor	Brand		MITSUBISHI ELECTRIC	MITSUBISHI ELECTRIC
	Model		ANB66FZXMT*2+ANB66FZXMT*2+ANB66FZXMT*2	ANB66FZXMT*2+ANB66FZXMT*2+ANB66FZXMT*2
	Type		DC INV. SCROLL	DC INV. SCROLL
	Compressor quantity		6INV	6INV
	Capacity	W	21300*2+21300*2+21300*2	21300*2+21300*2+21300*2
	Power Input	W	6600*2+6600*2+6600*2	6600*2+6600*2+6600*2
	Rated current(RLA)	A	21.5*2+21.5*2+21.5*2	21.5*2+21.5*2+21.5*2
	Speed	rps	60	60
	Crankcase Heater	W	132+132+132	132+132+132
	Refrigerant oil brand		IDEMITSUKOSAN CO.,LTD	IDEMITSUKOSAN CO.,LTD
	Refrigerant oil type		FVC68D	FVC68D
	Refrigerant oil charge	ml	(2300+1500)*2+(2300+1500)*2+(2300+1500)*2	(2300+1500)*2+(2300+1500)*2+(2300+1500)*2
Outdoor fan motor	Brand		BROAD-OCEAN	BROAD-OCEAN
	Model		(ZWK924D500002+ZWK924D500002)*3	(ZWK924D500002+ZWK924D500002)*3
	Voltage		DC540V	DC540V
	IP Class		IP44	IP44
	Type/quantity		DC/2+DC/2+DC/2	DC/2+DC/2+DC/2
	Insulation class		B	B
	Safe class		I	I
	Power Input	W	2320+2320+2320	2320+2320+2320
	Output	W	1800+1800+1800	1800+1800+1800
	Rated current	A	8+8+8	8+8+8
	Capacitor	μF	/	/
	Speed	rpm	0~1180	0~1180

Model			AV68NMVETA	AV70NMVETA
Outdoor fan	Brand		Tian Da+Tian Da+Tian Da	Tian Da+Tian Da+Tian Da
	Model		/	/
	Material		ABS+20%GF	ABS+20%GF
	Type		Axial	Axial
	Diameter	mm	Φ642+Φ642+Φ642+Φ642	Φ642+Φ642+Φ642+Φ642
	Height	mm	198+198+198	198+198+198
Outdoor coil	Number of rows		3+3+3	3+3+3
	Tube pitch(a)x row pitch(b)	mm	21×18.186	21×18.186
	Fin spacing	mm	1.6	1.6
	Fin type(code)		Hydrophilic aluminum	Hydrophilic aluminum
	Fin coating Type	Optional	Clear lacquer	Clear lacquer
	Salt Spray Test Duration	Hour	168	168
	Tube outside dia.and type	mm	INNERGROOVE TUBE Φ7	INNERGROOVE TUBE Φ7
Coil length x height	mm	(2843*1260+2757*1260+2669*1260)+(2843*1260+2757*1260+2669*1260) +(2843*1260+2757*1260+2669*1260)	(2843*1260+2757*1260+2669*1260)+(2843*1260+2757*1260+2669*1260) +(2843*1260+2757*1260+2669*1260)	
Number or circuits		29	29	
Cabinet coating	Coating type		Powerr Coating	Powerr Coating
	Salt Spray Test Duration	Hour	72	72
	Sheet Metal Material		Hot zinc plate	Hot zinc plate
	Sheet Metal Thickness	mm	1	1
Control panel enclosure IP class	standard	IP24	IP24	
Outdoor air flow (cooling/heating)	m ³ /h	54000	54000	
External static pressure	Pa	110	110	
Outdoor sound level(sound power level) (H)	dB(A)	95	95	
Outdoor unit	Diamension(W*D*H)	mm	1410/750/1690+1410/750/1690+1410/750/1690	1410/750/1690+1410/750/1690+1410/750/1690
	Packing(W*D*H)	mm	1515/850/1858+1515/850/1858+1515/850/1858	1515/850/1858+1515/850/1858+1515/850/1858
	Net weight	kg	385+385+385	385+385+385
	Gross weight	kg	410+410+410	410+410+410
Refrigerant	Type		R410A	R410A
	Charged volume	kg	30	30
Throttle type		EXV	EXV	
Design pressure	Mpa	4.15	4.15	

Model			AV68NMVETA	AV70NMVETA
Frigerant piping	Liquid pipe	mm	22.2	22.2
	Gas pipe	mm	44.5	44.5
	Oil pipe	mm	/	/
	Total pipe length	m	1000	1000
	Max. pipe length(Equivalent/Actual)	m	260/220	260/220
	Max. Diff. indoor/outdoor unit*1	m	110/90	110/90
	Standard Diff. indoor/outdoor unit	m	50/40	50/40
	Max./standard Diff. indoor/indoor unit*1	m	30/18	30/18
Connectable indoor unit ratio		%	50~130	50~130
Maximum indoor units		Piece	64	64
Connection wiring	Max. fuse current	A	189.00	189.00
	Min. wiring current	A	145.30	146.30
	Power wiring	mm ²	16+16+25	16+25+25
	Signal wiring	mm ²	2×0.75	2×0.75
Operation Range		°C	Cooling:-5~52 Heating:-27~21	Cooling:-5~52 Heating:-27~21

Nominal condition: indoor temperature (cooling): 27°C DB/19°C WB, indoor temperature (heating): 20°C DB/14.5°C WB.

Outdoor temperature(cooling): 35°C DB/24°C WB, outdoor temperature(heating): 7°C DB/6°C WB The data is measured with 7.5m equivalent pipe and 0 m height difference.

The noise level will be measured in the third octave band limited values in the semi-anechoic chamber, using a Real Time Analyser calibrated sound intensity meter. It is a sound pressure noise level.

*1 If the total pipe length is from 500 to 1000m or the height difference between the outdoor and indoor units is from 50 to 110m or the height difference between the indoor units is from 18 to 30m, you Must contact your local distributor/dealer for individual design and production.

Model			AV72NMVETA	AV74NMVETA
HP			72	74
Combination			24+24+24	24+24+26
Power supply		Ph/V/Hz	3/380~415/50/60	3/380~415/50/60
Cooling	Rated capacity	kW	204.0	209.5
	Rated capacity	kBtu/h	696.08	714.84
	Rated power input	kW	55.83	58.47
	Max. power input	kW	98.43	100.97
	Rated current	A	94.26	98.71
	Max. current	A	162.36	167.10
	EER		3.65	3.58
	AEER		6.98	6.92
Heating	Rated capacity	kw	204.0	209.5
	Rated capacity	kBtu/h	696.08	714.84
	Rated power input	kW	56.59	59.35
	Max. power input	kW	91.20	93.25
	Rated current	A	98.40	103.20
	Max. current	A	151.85	155.26
	COP		3.60	3.52
	ACOP		4.34	4.16
Compressor	Brand		MITSUBISHI ELECTRIC	MITSUBISHI ELECTRIC
	Model		ANB66FZXMT*2+ANB66FZXMT*2+ANB66FZXMT*2	ANB66FZXMT*2+ANB66FZXMT*2+ANB78FZXMT*2
	Type		DC INV. SCROLL	DC INV. SCROLL
	Compressor quantity		6INV	6INV
	Capacity	W	21300*2+21300*2+21300*2	21300*2+21300*2+25200*2
	Power Input	W	6600*2+6600*2+6600*2	6600*2+6600*2+7700*2
	Rated current(RLA)	A	21.5*2+21.5*2+21.5*2	21.5*2+21.5*2+26*2
	Speed	rps	60	60
	Crankcase Heater	W	132+132+132	132+132+132
	Refrigerant oil brand		IDEMITSUKOSAN CO.,LTD	IDEMITSUKOSAN CO.,LTD
	Refrigerant oil type		FVC68D	FVC68D
	Refrigerant oil charge	ml	(2300+1500)*2+(2300+1500)*2+(2300+1500)*2	(2300+1500)*2+(2300+1500)*2+(2300+1500)*2
Outdoor fan motor	Brand		BROAD-OCEAN	BROAD-OCEAN
	Model		(ZWK924D500002+ZWK924D500002)*3	(ZWK924D500002+ZWK924D500002)*3
	Voltage		DC540V	DC540V
	IP Class		IP44	IP44
	Type/quantity		DC/2+DC/2+DC/2	DC/2+DC/2+DC/2
	Insulation class		B	B
	Safe class		I	I
	Power Input	W	2320+2320+2320	2320+2320+2320
	Output	W	1800+1800+1800	1800+1800+1800
	Rated current	A	8+8+8	8+8+8
	Capacitor	μF	/	/
	Speed	rpm	0~1180	0~1180

Model			AV72NMVETA	AV74NMVETA
Outdoor fan	Brand		Tian Da+Tian Da+Tian Da	Tian Da+Tian Da+Tian Da
	Model		/	/
	Material		ABS+20%GF	ABS+20%GF
	Type		Axial	Axial
	Diameter	mm	Φ642+Φ642+Φ642+Φ642	Φ642+Φ642+Φ642+Φ642
	Height	mm	198+198+198	198+198+198
Outdoor coil	Number of rows		3+3+3	3+3+3
	Tube pitch(a)x row pitch(b)	mm	21×18.186	21×18.186
	Fin spacing	mm	1.6	1.6
	Fin type(code)		Hydrophilic aluminum	Hydrophilic aluminum
	Fin coating Type	Optional	Clear lacquer	Clear lacquer
	Salt Spray Test Duration	Hour	168	168
	Tube outside dia.and type	mm	INNERGROOVE TUBE Φ7	INNERGROOVE TUBE Φ7
Coil length x height	mm	(2843*1260+2757*1260+2669*1260)+(2843*1260+2757*1260+2669*1260) +(2843*1260+2757*1260+2669*1260)	(2843*1260+2757*1260+2669*1260)+(2843*1260+2757*1260+2669*1260) +(2843*1260+2757*1260+2669*1260)	
Number or circuits		29	29	
Cabinet coating	Coating type		Powerr Coating	Powerr Coating
	Salt Spray Test Duration	Hour	72	72
	Sheet Metal Material		Hot zinc plate	Hot zinc plate
	Sheet Metal Thickness	mm	1	1
Control panel enclosure IP class	standard	IP24	IP24	
Outdoor air flow (cooling/heating)	m ³ /h	54000	55000	
External static pressure	Pa	110	110	
Outdoor sound level(sound power level) (H)	dB(A)	95	95	
Outdoor unit	Diamension(W*D*H)	mm	1410/750/1690+1410/750/1690+1410/750/1690	1410/750/1690+1410/750/1690+1410/750/1690
	Packing(W*D*H)	mm	1515/850/1858+1515/850/1858+1515/850/1858	1515/850/1858+1515/850/1858+1515/850/1858
	Net weight	kg	385+385+385	385+385+385
	Gross weight	kg	410+410+410	410+410+410
Refrigerant	Type		R410A	R410A
	Charged volume	kg	30	30
Throttle type		EXV	EXV	
Design pressure	Mpa	4.15	4.15	

Model			AV72NMVETA	AV74NMVETA
Frigerant piping	Liquid pipe	mm	22.2	22.2
	Gas pipe	mm	44.5	44.5
	Oil pipe	mm	/	/
	Total pipe length	m	1000	1000
	Max. pipe length(Equivalent/Actual)	m	260/220	260/220
	Max. Diff. indoor/outdoor unit*1	m	110/90	110/90
	Standard Diff. indoor/outdoor unit	m	50/40	50/40
	Max./standard Diff. indoor/indoor unit*1	m	30/18	30/18
Connectable indoor unit ratio		%	50~130	50~130
Maximum indoor units		Piece	64	64
Connection wiring	Max. fuse current	A	189.00	189.00
	Min. wiring current	A	147.30	154.00
	Power wiring	mm ²	25+25+25	25+25+25
	Signal wiring	mm ²	2×0.75	2×0.75
Operation Range		°C	Cooling:-5~52 Heating:-27~21	Cooling:-5~52 Heating:-27~21

Nominal condition: indoor temperature (cooling): 27°C DB/19°C WB, indoor temperature (heating): 20°C DB/14.5°C WB.

Outdoor temperature(cooling): 35°C DB/24°C WB, outdoor temperature(heating): 7°C DB/6°C WB The data is measured with 7.5m equivalent pipe and 0 m height difference.

The noise level will be measured in the third octave band limited values in the semi-anechoic chamber, using a Real Time Analyser calibrated sound intensity meter. It is a sound pressure noise level.

*1 If the total pipe length is from 500 to 1000m or the height difference between the outdoor and indoor units is from 50 to 110m or the height difference between the indoor units is from 18 to 30m, you Must contact your local distributor/dealer for individual design and production.

Model			AV76NMVETA	AV78NMVETA
HP			76	78
Combination			24+26+26	26+26+26
Power supply		Ph/V/Hz	3/380~415/50/60	3/380~415/50/60
Cooling	Rated capacity	kW	215.0	220.5
	Rated capacity	kBtu/h	733.61	752.38
	Rated power input	kW	61.10	63.74
	Max. power input	kW	103.51	106.05
	Rated current	A	103.15	107.60
	Max. current	A	171.84	176.57
	EER		3.52	3.46
	AEER		6.85	6.79
Heating	Rated capacity	kw	215.0	220.5
	Rated capacity	kBtu/h	733.61	752.38
	Rated power input	kW	62.11	64.87
	Max. power input	kW	95.30	97.35
	Rated current	A	108.00	112.80
	Max. current	A	158.67	162.09
	COP		3.46	3.39
	ACOP		4.01	3.88
Compressor	Brand		MITSUBISHI ELECTRIC	MITSUBISHI ELECTRIC
	Model		ANB66FZXMT*2+ANB78FZXMT*2+ANB78FZXMT*2	ANB78FZXMT*2+ANB78FZXMT*2+ANB78FZXMT*2
	Type		DC INV. SCROLL	DC INV. SCROLL
	Compressor quantity		6INV	6INV
	Capacity	W	21300*2+25200*2+25200*2	25200*2+25200*2+25200*2
	Power Input	W	6600*2+7700*2+7700*2	7700*2+7700*2+7700*2
	Rated current(RLA)	A	21.5*2+26*2+26*2	26*2+26*2+26*2
	Speed	rps	60	60
	Crankcase Heater	W	132+132+132	132+132+132
	Refrigerant oil brand		IDEMITSUKOSAN CO.,LTD	IDEMITSUKOSAN CO.,LTD
	Refrigerant oil type		FVC68D	FVC68D
	Refrigerant oil charge	ml	(2300+1500)*2+(2300+1500)*2+(2300+1500)*2	(2300+1500)*2+(2300+1500)*2+(2300+1500)*2
Outdoor fan motor	Brand		BROAD-OCEAN	BROAD-OCEAN
	Model		(ZWK924D500002+ZWK924D500002)*3	(ZWK924D500002+ZWK924D500002)*3
	Voltage		DC540V	DC540V
	IP Class		IP44	IP44
	Type/quantity		DC/2+DC/2+DC/2	DC/2+DC/2+DC/2
	Insulation class		B	B
	Safe class		I	I
	Power Input	W	2320+2320+2320	2320+2320+2320
	Output	W	1800+1800+1800	1800+1800+1800
	Rated current	A	8+8+8	8+8+8
	Capacitor	μF	/	/
	Speed	rpm	0~1180	0~1180

Model			AV76NMVETA	AV78NMVETA
Outdoor fan	Brand		Tian Da+Tian Da+Tian Da	Tian Da+Tian Da+Tian Da
	Model		/	/
	Material		ABS+20%GF	ABS+20%GF
	Type		Axial	Axial
	Diameter	mm	Φ642+Φ642+Φ642+Φ642	Φ642+Φ642+Φ642+Φ642
	Height	mm	198+198+198	198+198+198
Outdoor coil	Number of rows		3+3+3	3+3+3
	Tube pitch(a)x row pitch(b)	mm	21×18.186	21×18.186
	Fin spacing	mm	1.6	1.6
	Fin type(code)		Hydrophilic aluminum	Hydrophilic aluminum
	Fin coating Type	Optional	Clear lacquer	Clear lacquer
	Salt Spray Test Duration	Hour	168	168
	Tube outside dia.and type	mm	INNERGROOVE TUBE Φ7	INNERGROOVE TUBE Φ7
Coil length x height	mm	(2843*1260+2757*1260 +2669*1260)+(2843*1260+ 2757*1260+2669*1260) +(2843*1260+2757*1260 +2669*1260)	(2843*1260+2757*1260 +2669*1260)+(2843*1260+ 2757*1260+2669*1260) +(2843*1260+2757*1260 +2669*1260)	
Number or circuits		29	29	
Cabinet coating	Coating type		Powerr Coating	Powerr Coating
	Salt Spray Test Duration	Hour	72	72
	Sheet Metal Material		Hot zinc plate	Hot zinc plate
	Sheet Metal Thickness	mm	1	1
Control panel enclosure IP class	standard	IP24	IP24	
Outdoor air flow (cooling/heating)	m ³ /h	56000	57000	
External static pressure	Pa	110	110	
Outdoor sound level(sound power level) (H)	dB(A)	95	95	
Outdoor unit	Diamension(W*D*H)	mm	1410/750/1690+1410/750/1 690+1410/750/1690	1410/750/1690+1410/750/1 690+1410/750/1690
	Packing(W*D*H)	mm	1515/850/1858+1515/850/1 858+1515/850/1858	1515/850/1858+1515/850/1 858+1515/850/1858
	Net weight	kg	385+385+385	385+385+385
	Gross weight	kg	410+410+410	410+410+410
Refrigerant	Type		R410A	R410A
	Charged volume	kg	30	30
Throttle type			EXV	EXV
Design pressure	Mpa		4.15	4.15

Model			AV76NMVETA	AV78NMVETA
Frigerant piping	Liquid pipe	mm	22.2	22.2
	Gas pipe	mm	44.5	44.5
	Oil pipe	mm	/	/
	Total pipe length	m	1000	1000
	Max. pipe length(Equivalent/Actual)	m	260/220	260/220
	Max. Diff. indoor/outdoor unit*1	m	110/90	110/90
	Standard Diff. indoor/outdoor unit	m	50/40	50/40
	Max./standard Diff. indoor/indoor unit*1	m	30/18	30/18
Connectable indoor unit ratio		%	50~130	50~130
Maximum indoor units		Piece	64	64
Connection wiring	Max. fuse current	A	189.00	189.00
	Min. wiring current	A	160.70	167.40
	Power wiring	mm ²	25+25+25	25+25+25
	Signal wiring	mm ²	2×0.75	2×0.75
Operation Range		°C	Cooling:-5~52 Heating:-27~21	Cooling:-5~52 Heating:-27~21

Nominal condition: indoor temperature (cooling): 27°C DB/19°C WB, indoor temperature (heating): 20°C DB/14.5°C WB.

Outdoor temperature(cooling): 35°C DB/24°C WB, outdoor temperature(heating): 7°C DB/6°C WB The data is measured with 7.5m equivalent pipe and 0 m height difference.

The noise level will be measured in the third octave band limited values in the semi-anechoic chamber, using a Real Time Analyser calibrated sound intensity meter. It is a sound pressure noise level.

*1 If the total pipe length is from 500 to 1000m or the height difference between the outdoor and indoor units is from 50 to 110m or the height difference between the indoor units is from 18 to 30m, you Must contact your local distributor/dealer for individual design and production.

Model			AV80NMVETA	AV82NMVETA
HP			80	82
Combination			20+20+20+20	20+20+20+22
Power supply		Ph/V/Hz	3/380~415/50/60	3/380~415/50/60
Cooling	Rated capacity	kW	224.0	229.5
	Rated capacity	kBtu/h	764.32	783.09
	Rated power input	kW	66.47	68.16
	Max. power input	kW	115.64	118.55
	Rated current	A	112.21	115.06
	Max. current	A	185.20	190.81
	EER		3.37	3.37
	AEER		6.82	6.76
Heating	Rated capacity	kw	224.0	229.5
	Rated capacity	kBtu/h	764.32	783.09
	Rated power input	kW	56.93	58.84
	Max. power input	kW	98.80	99.79
	Rated current	A	98.99	102.31
	Max. current	A	164.50	166.15
	COP		3.93	3.90
	ACOP		4.38	4.38
Compressor	Brand		MITSUBISHI ELECTRIC	MITSUBISHI ELECTRIC
	Model		ANB52FZJMT*2+ANB52FZJMT*2 +ANB52FZJMT*2+ANB52FZJMT*2	ANB52FZJMT*2+ANB52FZJMT*2 +ANB52FZJMT*2+ANB66FZJMT*2
	Type		DC INV. SCROLL	DC INV. SCROLL
	Compressor quantity		8INV	8INV
	Capacity	W	16800*2+16800*2 +16800*2+16800*2	16800*2+16800*2 +16800*2+21300*2
	Power Input	W	5250*2+5250*2 +5250*2+5250*2	5250*2+5250*2 +5250*2+6600*2
	Rated current(RLA)	A	16.5*2+16.5*2+16.5*2+16.5*2	16.5*2+16.5*2+16.5*2+21.5*2
	Speed	rps	60	60
	Crankcase Heater	W	132+132+132+132	132+132+132+132
	Refrigerant oil brand		IDEMITSUKOSAN CO.,LTD	IDEMITSUKOSAN CO.,LTD
	Refrigerant oil type		FVC68D	FVC68D
	Refrigerant oil charge	ml	(2300+1500)*2+(2300+1500)*2 +(2300+1500)*2+(2300+1500)*2	(2300+1500)*2+(2300+1500)*2 +(2300+1500)*2+(2300+1500)*2
Outdoor fan motor	Brand		BROAD-OCEAN	BROAD-OCEAN
	Model		(ZWK924D500002 +ZWK924D500002)*4	(ZWK924D500002 +ZWK924D500002)*4
	Voltage		DC540V	DC540V
	IP Class		IP44	IP44
	Type/quantity		DC/2+DC/2+DC/2+DC/2	DC/2+DC/2+DC/2+DC/2
	Insulation class		B	B
	Safe class		I	I
	Power Input	W	2320+2320+2320+2320	2320+2320+2320+2320
	Output	W	1800+1800+1800+1800	1800+1800+1800+1800
	Rated current	A	8+8+8+8	8+8+8+8
	Capacitor	μF	/	/
	Speed	rpm	0~1180	0~1180

Model			AV80NMVETA	AV82NMVETA
Outdoor fan	Brand		Tian Da+Tian Da+Tian Da+Tian Da	Tian Da+Tian Da+Tian Da+Tian Da
	Model		/	/
	Material		ABS+20%GF	ABS+20%GF
	Type		Axial	Axial
	Diameter	mm	Φ642+Φ642+Φ642+Φ642	Φ642+Φ642+Φ642+Φ642
	Height	mm	198+198+198+198	198+198+198+198
Outdoor coil	Number of rows		3+3+3+3	3+3+3+3
	Tube pitch(a)x row pitch(b)	mm	21×18.186	21×18.186
	Fin spacing	mm	1.6	1.6
	Fin type(code)		Hydrophilic aluminum	21×18.186
	Fin coating Type	Optional	Clear lacquer	1.6
	Salt Spray Test Duration	Hour	168	168
	Tube outside dia.and type	mm	INNERGROOVE TUBE Φ7	INNERGROOVE TUBE Φ7
Coil length x height	mm	(2843*1260+2757*1260+2669*1260)+(2843*1260+2757*1260+2669*1260)+(2843*1260+2757*1260+2669*1260)+(2843*1260+2757*1260+2669*1260)	(2843*1260+2757*1260+2669*1260)+(2843*1260+2757*1260+2669*1260)+(2843*1260+2757*1260+2669*1260)+(2843*1260+2757*1260+2669*1260)	
Number or circuits		29	29	
Cabinet coating	Coating type		Powerr Coating	Powerr Coating
	Salt Spray Test Duration	Hour	72	72
	Sheet Metal Material		Hot zinc plate	Hot zinc plate
	Sheet Metal Thickness	mm	1	1
Control panel enclosure IP class	standard		IP24	IP24
Outdoor air flow (cooling/heating)	m ³ /h		68000	69000
External static pressure	Pa		110	110
Outdoor sound level(sound power level) (H)	dB(A)		94	95
Outdoor unit	Diamension(W*D*H)	mm	1410/750/1690+1410/750/1690+1410/750/1690+1410/750/1690	1410/750/1690+1410/750/1690+1410/750/1690+1410/750/1690
	Packing(W*D*H)	mm	1515/850/1858+1515/850/1858+1515/850/1858+1515/850/1858	1515/850/1858+1515/850/1858+1515/850/1858+1515/850/1858
	Net weight	kg	385+385+385+385	385+385+385+385
	Gross weight	kg	410+410+410+410	410+410+410+410
Refrigerant	Type		R410A	R410A
	Charged volume	kg	40	40
Throttle type			EXV	EXV
Design pressure		Mpa	4.15	4.15

Model			AV80NMVETA	AV82NMVETA
Frigerant piping	Liquid pipe	mm	22.2	22.2
	Gas pipe	mm	44.5	44.5
	Oil pipe	mm	/	/
	Total pipe length	m	1000	1000
	Max. pipe length(Equivalent/Actual)	m	260/220	260/220
	Max. Diff. indoor/outdoor unit*1	m	110/90	110/90
	Standard Diff. indoor/outdoor unit	m	50/40	50/40
	Max./standard Diff. indoor/indoor unit*1	m	30/18	30/18
Connectable indoor unit ratio		%	50~130	50~130
Maximum indoor units		Piece	64	64
Connection wiring	Max. fuse current	A	200.00	213.00
	Min. wiring current	A	169.60	175.30
	Power wiring	mm ²	16+16+16+16	16+16+16+16
	Signal wiring	mm ²	2×0.75	2×0.75
Operation Range		°C	Cooling:-5~52 Heating:-27~21	Cooling:-5~52 Heating:-27~21

Nominal condition: indoor temperature (cooling): 27°C DB/19°C WB, indoor temperature (heating): 20°C DB/14.5°C WB.

Outdoor temperature(cooling): 35°C DB/24°C WB, outdoor temperature(heating): 7°C DB/6°C WB The data is measured with 7.5m equivalent pipe and 0 m height difference.

The noise level will be measured in the third octave band limited values in the semi-anechoic chamber, using a Real Time Analyser calibrated sound intensity meter. It is a sound pressure noise level.

*1 If the total pipe length is from 500 to 1000m or the height difference between the outdoor and indoor units is from 50 to 110m or the height difference between the indoor units is from 18 to 30m, you Must contact your local distributor/dealer for individual design and production.

Model			AV84NMVETA	AV86NMVETA
HP			84	86
Combination			20+20+22+22	20+22+22+22
Power supply		Ph/V/Hz	3/380~415/50/60	3/380~415/50/60
Cooling	Rated capacity	kW	235.0	240.5
	Rated capacity	kBtu/h	801.85	820.62
	Rated power input	kW	69.84	71.53
	Max. power input	kW	121.46	124.37
	Rated current	A	117.91	120.75
	Max. current	A	196.42	202.03
	EER		3.36	3.36
	AEER		6.71	6.65
Heating	Rated capacity	kw	235.0	240.5
	Rated capacity	kBtu/h	801.85	820.62
	Rated power input	kW	60.74	62.65
	Max. power input	kW	100.78	101.78
	Rated current	A	105.62	108.93
	Max. current	A	167.81	169.46
	COP		3.86	3.83
	ACOP		4.38	4.39
Compressor	Brand		MITSUBISHI ELECTRIC	MITSUBISHI ELECTRIC
	Model		ANB52FZJMT*2+ANB52FZJMT*2+ANB66FZXMT*2+ANB66FZXMT*2	ANB52FZJMT*2+ANB66FZXMT*2+ANB66FZXMT*2+ANB66FZXMT*2
	Type		DC INV. SCROLL	DC INV. SCROLL
	Compressor quantity		8INV	8INV
	Capacity	W	16800*2+16800*2+21300*2+21300*2	16800*2+21300*2+21300*2+21300*2
	Power Input	W	5250*2+5250*2+6600*2+6600*2	5250*2+6600*2+6600*2+6600*2
	Rated current(RLA)	A	16.5*2+16.5*2+21.5*2+21.5*2	16.5*2+21.5*2+21.5*2+21.5*2
	Speed	rps	60	60
	Crankcase Heater	W	132+132+132+132	132+132+132+132
	Refrigerant oil brand		IDEMITSUKOSAN CO.,LTD	IDEMITSUKOSAN CO.,LTD
	Refrigerant oil type		FVC68D	FVC68D
	Refrigerant oil charge	ml	(2300+1500)*2+(2300+1500)*2+(2300+1500)*2+(2300+1500)*2	(2300+1500)*2+(2300+1500)*2+(2300+1500)*2+(2300+1500)*2
Outdoor fan motor	Brand		BROAD-OCEAN	BROAD-OCEAN
	Model		(ZWK924D500002+ZWK924D500002)*4	(ZWK924D500002+ZWK924D500002)*4
	Voltage		DC540V	DC540V
	IP Class		IP44	IP44
	Type/quantity		DC/2+DC/2+DC/2+DC/2	DC/2+DC/2+DC/2+DC/2
	Insulation class		B	B
	Safe class		I	I
	Power Input	W	2320+2320+2320+2320	2320+2320+2320+2320
	Output	W	1800+1800+1800+1800	1800+1800+1800+1800
	Rated current	A	8+8+8+8	8+8+8+8
	Capacitor	μF	/	/
	Speed	rpm	0~1180	0~1180

Model			AV84NMVETA	AV86NMVETA	
Outdoor fan	Brand		Tian Da+Tian Da+Tian Da+Tian Da	Tian Da+Tian Da+Tian Da+Tian Da	
	Model		/	/	
	Material		ABS+20%GF	ABS+20%GF	
	Type		Axial	Axial	
	Diameter	mm	Φ642+Φ642+Φ642+Φ642	Φ642+Φ642+Φ642+Φ642	
	Height	mm	198+198+198+198	198+198+198+198	
Outdoor coil	Number of rows		3+3+3+3	3+3+3+3	
	Tube pitch(a)x row pitch(b)	mm	21×18.186	21×18.186	
	Fin spacing	mm	1.6	1.6	
	Fin type(code)		21×18.186	21×18.186	
	Fin coating Type	Optional	1.6	1.6	
	Salt Spray Test Duration	Hour	168	168	
	Tube outside dia.and type	mm		INNERGROOVE TUBE	INNERGROOVE TUBE
				Φ7	Φ7
Coil length x height	mm	(2843*1260+2757*1260+2669*1260)+(2843*1260+2757*1260+2669*1260)+(2843*1260+2757*1260+2669*1260)+(2843*1260+2757*1260+2669*1260)	(2843*1260+2757*1260+2669*1260)+(2843*1260+2757*1260+2669*1260)+(2843*1260+2757*1260+2669*1260)+(2843*1260+2757*1260+2669*1260)		
Number or circuits		29	29		
Cabinet coating	Coating type		Powerr Coating	Powerr Coating	
	Salt Spray Test Duration	Hour	72	72	
	Sheet Metal Material		Hot zinc plate	Hot zinc plate	
	Sheet Metal Thickness	mm	1	1	
Control panel enclosure IP class	standard		IP24	IP24	
Outdoor air flow (cooling/heating)	m ³ /h		70000	71000	
External static pressure	Pa		110	110	
Outdoor sound level(sound power level) (H)	dB(A)		95	96	
Outdoor unit	Diamension(W*D*H)	mm	1410/750/1690+1410/750/1690+1410/750/1690+1410/750/1690	1410/750/1690+1410/750/1690+1410/750/1690+1410/750/1690	
	Packing(W*D*H)	mm	1515/850/1858+1515/850/1858+1515/850/1858+1515/850/1858	1515/850/1858+1515/850/1858+1515/850/1858+1515/850/1858	
	Net weight	kg	385+385+385+385	385+385+385+385	
	Gross weight	kg	410+410+410+410	410+410+410+410	
Refrigerant	Type		R410A	R410A	
	Charged volume	kg	40	40	
Throttle type			EXV	EXV	
Design pressure		Mpa	4.15	4.15	

Model			AV84NMVETA	AV86NMVETA
Frigerant piping	Liquid pipe	mm	22.2	25.4
	Gas pipe	mm	44.5	50.8
	Oil pipe	mm	/	/
	Total pipe length	m	1000	1000
	Max. pipe length(Equivalent/Actual)	m	260/220	260/220
	Max. Diff. indoor/outdoor unit*1	m	110/90	110/90
	Standard Diff. indoor/outdoor unit	m	50/40	50/40
	Max./standard Diff. indoor/indoor unit*1	m	30/18	30/18
Connectable indoor unit ratio		%	50~130	50~130
Maximum indoor units		Piece	64	64
Connection wiring	Max. fuse current	A	226.00	239.00
	Min. wiring current	A	181.00	186.70
	Power wiring	mm ²	16+16+16+16	16+16+16+16
	Signal wiring	mm ²	2×0.75	2×0.75
Operation Range		°C	Cooling:-5~52 Heating:-27~21	Cooling:-5~52 Heating:-27~21

Nominal condition: indoor temperature (cooling): 27°C DB/19°C WB, indoor temperature (heating): 20°C DB/14.5°C WB.

Outdoor temperature(cooling): 35°C DB/24°C WB, outdoor temperature(heating): 7°C DB/6°C WB The data is measured with 7.5m equivalent pipe and 0 m height difference.

The noise level will be measured in the third octave band limited values in the semi-anechoic chamber, using a Real Time Analyser calibrated sound intensity meter. It is a sound pressure noise level.

*1 If the total pipe length is from 500 to 1000m or the height difference between the outdoor and indoor units is from 50 to 110m or the height difference between the indoor units is from 18 to 30m, you Must contact your local distributor/dealer for individual design and production.

Model			AV88NMVETA	AV90NMVETA
HP			88	90
Combination			22+22+22+22	22+22+22+24
Power supply		Ph/V/Hz	3/380~415/50/60	3/380~415/50/60
Cooling	Rated capacity	kW	246.0	252.5
	Rated capacity	kBtu/h	839.39	861.57
	Rated power input	kW	73.21	73.52
	Max. power input	kW	127.28	128.27
	Rated current	A	123.60	124.12
	Max. current	A	207.64	209.85
	EER		3.36	3.43
	AEER		6.61	6.70
Heating	Rated capacity	kw	246.0	252.5
	Rated capacity	kBtu/h	839.39	861.57
	Rated power input	kW	64.55	67.28
	Max. power input	kW	102.77	107.48
	Rated current	A	112.24	116.98
	Max. current	A	171.11	178.95
	COP		3.81	3.75
	ACOP		4.39	4.38
Compressor	Brand		MITSUBISHI ELECTRIC	MITSUBISHI ELECTRIC
	Model		ANB66FZXMT*2+ANB66FZXMT*2+ANB66FZXMT*2+ANB66FZXMT*2	ANB66FZXMT*2+ANB66FZXMT*2+ANB66FZXMT*2+ANB66FZXMT*2
	Type		DC INV. SCROLL	DC INV. SCROLL
	Compressor quantity		8INV	8INV
	Capacity	W	21300*2+21300*2+21300*2+21300*2	21300*2+21300*2+21300*2+21300*2
	Power Input	W	6600*2+6600*2+6600*2+6600*2	6600*2+6600*2+6600*2+6600*2
	Rated current(RLA)	A	21.5*2+21.5*2+21.5*2+21.5*2	21.5*2+21.5*2+21.5*2+21.5*2
	Speed	rps	60	60
	Crankcase Heater	W	132+132+132+132	132+132+132+132
	Refrigerant oil brand		IDEMITSUKOSAN CO.,LTD	IDEMITSUKOSAN CO.,LTD
	Refrigerant oil type		FVC68D	FVC68D
	Refrigerant oil charge	ml	(2300+1500)*2+(2300+1500)*2+(2300+1500)*2+(2300+1500)*2	(2300+1500)*2+(2300+1500)*2+(2300+1500)*2+(2300+1500)*2
Outdoor fan motor	Brand		BROAD-OCEAN	BROAD-OCEAN
	Model		(ZWK924D500002+ZWK924D500002)*4	(ZWK924D500002+ZWK924D500002)*4
	Voltage		DC540V	DC540V
	IP Class		IP44	IP44
	Type/quantity		DC/2+DC/2+DC/2+DC/2	DC/2+DC/2+DC/2+DC/2
	Insulation class		B	B
	Safe class		I	I
	Power Input	W	2320+2320+2320+2320	2320+2320+2320+2320
	Output	W	1800+1800+1800+1800	1800+1800+1800+1800
	Rated current	A	8+8+8+8	8+8+8+8
	Capacitor	μF	/	/
	Speed	rpm	0~1180	0~1180

Model			AV88NMVETA	AV90NMVETA	
Outdoor fan	Brand		Tian Da+Tian Da+Tian Da+Tian Da	Tian Da+Tian Da+Tian Da+Tian Da	
	Model		/	/	
	Material		ABS+20%GF	ABS+20%GF	
	Type		Axial	Axial	
	Diameter	mm	Φ642+Φ642+Φ642+Φ642	Φ642+Φ642+Φ642+Φ642	
	Height	mm	198+198+198+198	198+198+198+198	
Outdoor coil	Number of rows		3+3+3+3	3+3+3+3	
	Tube pitch(a)x row pitch(b)	mm	21×18.186	21×18.186	
	Fin spacing	mm	1.6	1.6	
	Fin type(code)		21×18.186	21×18.186	
	Fin coating Type	Optional	1.6	1.6	
	Salt Spray Test Duration	Hour	168	168	
	Tube outside dia.and type	mm		INNERGROOVE TUBE	INNERGROOVE TUBE
				Φ7	Φ7
Coil length x height	mm	(2843*1260+2757*1260+2669*1260)+(2843*1260+2757*1260+2669*1260)+(2843*1260+2757*1260+2669*1260)+(2843*1260+2757*1260+2669*1260)	(2843*1260+2757*1260+2669*1260)+(2843*1260+2757*1260+2669*1260)+(2843*1260+2757*1260+2669*1260)+(2843*1260+2757*1260+2669*1260)		
Number or circuits		29	29		
Cabinet coating	Coating type		Powerr Coating	Powerr Coating	
	Salt Spray Test Duration	Hour	72	72	
	Sheet Metal Material		Hot zinc plate	Hot zinc plate	
	Sheet Metal Thickness	mm	1	1	
Control panel enclosure IP class	standard		IP24	IP24	
Outdoor air flow (cooling/heating)	m ³ /h		72000	72000	
External static pressure	Pa		110	110	
Outdoor sound level(sound power level) (H)	dB(A)		96	96	
Outdoor unit	Diamension(W*D*H)	mm	1410/750/1690+1410/750/1690+1410/750/1690+1410/750/1690	1410/750/1690+1410/750/1690+1410/750/1690+1410/750/1690	
	Packing(W*D*H)	mm	1515/850/1858+1515/850/1858+1515/850/1858+1515/850/1858	1515/850/1858+1515/850/1858+1515/850/1858+1515/850/1858	
	Net weight	kg	385+385+385+385	385+385+385+385	
	Gross weight	kg	410+410+410+410	410+410+410+410	
Refrigerant	Type		R410A	R410A	
	Charged volume	kg	80	80	
Throttle type			EXV	EXV	
Design pressure		Mpa	4.15	4.15	

Model			AV88NMVETA	AV90NMVETA
Frigerant piping	Liquid pipe	mm	25.4	25.4
	Gas pipe	mm	50.8	50.8
	Oil pipe	mm	/	/
	Total pipe length	m	1000	1000
	Max. pipe length(Equivalent/Actual)	m	260/220	260/220
	Max. Diff. indoor/outdoor unit*1	m	110/90	110/90
	Standard Diff. indoor/outdoor unit	m	50/40	50/40
	Max./standard Diff. indoor/indoor unit*1	m	30/18	30/18
Connectable indoor unit ratio		%	50~130	50~130
Maximum indoor units		Piece	64	64
Connection wiring	Max. fuse current	A	252.00	252.00
	Min. wiring current	A	192.40	193.40
	Power wiring	mm ²	16+16+16+16	16+16+16+25
	Signal wiring	mm ²	2×0.75	2×0.75
Operation Range		°C	Cooling:-5~52 Heating:-27~21	Cooling:-5~52 Heating:-27~21

Nominal condition: indoor temperature (cooling): 27°C DB/19°C WB, indoor temperature (heating): 20°C DB/14.5°C WB.

Outdoor temperature(cooling): 35°C DB/24°C WB, outdoor temperature(heating): 7°C DB/6°C WB The data is measured with 7.5m equivalent pipe and 0 m height difference.

The noise level will be measured in the third octave band limited values in the semi-anechoic chamber, using a Real Time Analyser calibrated sound intensity meter. It is a sound pressure noise level.

*1 If the total pipe length is from 500 to 1000m or the height difference between the outdoor and indoor units is from 50 to 110m or the height difference between the indoor units is from 18 to 30m, you Must contact your local distributor/dealer for individual design and production.

Model			AV92NMVETA	AV94NMVETA
HP			92	94
Combination			22+22+24+24	22+24+24+24
Power supply		Ph/V/Hz	3/380~415/50/60	3/380~415/50/60
Cooling	Rated capacity	kW	259.0	265.5
	Rated capacity	kBtu/h	883.74	905.92
	Rated power input	kW	73.83	74.14
	Max. power input	kW	129.26	130.25
	Rated current	A	124.64	125.16
	Max. current	A	212.06	214.27
	EER		3.51	3.58
	AEER		6.80	6.90
Heating	Rated capacity	kw	259.0	265.5
	Rated capacity	kBtu/h	883.74	905.92
	Rated power input	kW	70.00	72.73
	Max. power input	kW	112.18	116.89
	Rated current	A	121.72	126.46
	Max. current	A	186.79	194.63
	COP		3.69	3.65
	ACOP		4.36	4.35
Compressor	Brand		MITSUBISHI ELECTRIC	MITSUBISHI ELECTRIC
	Model		ANB66FZXMT*2+ANB66FZXMT*2+ANB66FZXMT*2+ANB66FZXMT*2	ANB66FZXMT*2+ANB66FZXMT*2+ANB66FZXMT*2+ANB66FZXMT*2
	Type		DC INV. SCROLL	DC INV. SCROLL
	Compressor quantity		8INV	8INV
	Capacity	W	21300*2+21300*2+21300*2+21300*2	21300*2+21300*2+21300*2+21300*2
	Power Input	W	6600*2+6600*2+6600*2+6600*2	6600*2+6600*2+6600*2+6600*2
	Rated current(RLA)	A	21.5*2+21.5*2+21.5*2+21.5*2	21.5*2+21.5*2+21.5*2+21.5*2
	Speed	rps	60	60
	Crankcase Heater	W	132+132+132+132	132+132+132+132
	Refrigerant oil brand		IDEMITSUKOSAN CO.,LTD	IDEMITSUKOSAN CO.,LTD
	Refrigerant oil type		FVC68D	FVC68D
	Refrigerant oil charge	ml	(2300+1500)*2+(2300+1500)*2+(2300+1500)*2+(2300+1500)*2	(2300+1500)*2+(2300+1500)*2+(2300+1500)*2+(2300+1500)*2
Outdoor fan motor	Brand		BROAD-OCEAN	BROAD-OCEAN
	Model		(ZWK924D500002+ZWK924D500002)*4	(ZWK924D500002+ZWK924D500002)*4
	Voltage		DC540V	DC540V
	IP Class		IP44	IP44
	Type/quantity		DC/2+DC/2+DC/2+DC/2	DC/2+DC/2+DC/2+DC/2
	Insulation class		B	B
	Safe class		I	I
	Power Input	W	2320+2320+2320+2320	2320+2320+2320+2320
	Output	W	1800+1800+1800+1800	1800+1800+1800+1800
	Rated current	A	8+8+8+8	8+8+8+8
	Capacitor	μF	/	/
	Speed	rpm	0~1180	0~1180

Model			AV92NMVETA	AV94NMVETA	
Outdoor fan	Brand		Tian Da+Tian Da+Tian Da+Tian Da	Tian Da+Tian Da+Tian Da+Tian Da	
	Model		/	/	
	Material		ABS+20%GF	ABS+20%GF	
	Type		Axial	Axial	
	Diameter	mm	Φ642+Φ642+Φ642+Φ642	Φ642+Φ642+Φ642+Φ642	
	Height	mm	198+198+198+198	198+198+198+198	
Outdoor coil	Number of rows		3+3+3+3	3+3+3+3	
	Tube pitch(a)x row pitch(b)	mm	21×18.186	21×18.186	
	Fin spacing	mm	1.6	1.6	
	Fin type(code)		21×18.186	21×18.186	
	Fin coating Type	Optional	1.6	1.6	
	Salt Spray Test Duration	Hour	168	168	
	Tube outside dia.and type	mm		INNERGROOVE TUBE	INNERGROOVE TUBE
				Φ7	Φ7
Coil length x height	mm	(2843*1260+2757*1260+2669*1260)+(2843*1260+2757*1260+2669*1260)+(2843*1260+2757*1260+2669*1260)+(2843*1260+2757*1260+2669*1260)	(2843*1260+2757*1260+2669*1260)+(2843*1260+2757*1260+2669*1260)+(2843*1260+2757*1260+2669*1260)+(2843*1260+2757*1260+2669*1260)		
Number or circuits		29	29		
Cabinet coating	Coating type		Powerr Coating	Powerr Coating	
	Salt Spray Test Duration	Hour	72	72	
	Sheet Metal Material		Hot zinc plate	Hot zinc plate	
	Sheet Metal Thickness	mm	1	1	
Control panel enclosure IP class	standard		IP24	IP24	
Outdoor air flow (cooling/heating)	m ³ /h		72000	72000	
External static pressure	Pa		110	110	
Outdoor sound level(sound power level) (H)	dB(A)		96	96	
Outdoor unit	Diamension(W*D*H)	mm	1410/750/1690+1410/750/1690+1410/750/1690+1410/750/1690	1410/750/1690+1410/750/1690+1410/750/1690+1410/750/1690	
	Packing(W*D*H)	mm	1515/850/1858+1515/850/1858+1515/850/1858+1515/850/1858	1515/850/1858+1515/850/1858+1515/850/1858+1515/850/1858	
	Net weight	kg	385+385+385+385	385+385+385+385	
	Gross weight	kg	410+410+410+410	410+410+410+410	
Refrigerant	Type		R410A	R410A	
	Charged volume	kg	80	80	
Throttle type			EXV	EXV	
Design pressure		Mpa	4.15	4.15	

Model			AV92NMVETA	AV94NMVETA
Frigerant piping	Liquid pipe	mm	25.4	25.4
	Gas pipe	mm	50.8	50.8
	Oil pipe	mm	/	/
	Total pipe length	m	1000	1000
	Max. pipe length(Equivalent/Actual)	m	260/220	260/220
	Max. Diff. indoor/outdoor unit*1	m	110/90	110/90
	Standard Diff. indoor/outdoor unit	m	50/40	50/40
	Max./standard Diff. indoor/indoor unit*1	m	30/18	30/18
Connectable indoor unit ratio		%	50~130	50~130
Maximum indoor units		Piece	64	64
Connection wiring	Max. fuse current	A	252.00	252.00
	Min. wiring current	A	194.40	195.40
	Power wiring	mm ²	16+16+25+25	16+25+25+25
	Signal wiring	mm ²	2×0.75	2×0.75
Operation Range		°C	Cooling:-5~52 Heating:-27~21	Cooling:-5~52 Heating:-27~21

Nominal condition: indoor temperature (cooling): 27°C DB/19°C WB, indoor temperature (heating): 20°C DB/14.5°C WB.

Outdoor temperature(cooling): 35°C DB/24°C WB, outdoor temperature(heating): 7°C DB/6°C WB The data is measured with 7.5m equivalent pipe and 0 m height difference.

The noise level will be measured in the third octave band limited values in the semi-anechoic chamber, using a Real Time Analyser calibrated sound intensity meter. It is a sound pressure noise level.

*1 If the total pipe length is from 500 to 1000m or the height difference between the outdoor and indoor units is from 50 to 110m or the height difference between the indoor units is from 18 to 30m, you Must contact your local distributor/dealer for individual design and production.

Model			AV96NMVETA	AV98NMVETA
HP			96	98
Combination			24+24+24+24	24+24+24+26
Power supply		Ph/V/Hz	3/380~415/50/60	3/380~415/50/60
Cooling	Rated capacity	kW	272.0	277.5
	Rated capacity	kBtu/h	928.10	946.87
	Rated power input	kW	74.44	77.08
	Max. power input	kW	131.24	133.78
	Rated current	A	125.68	130.13
	Max. current	A	216.48	221.22
	EER		3.65	3.60
	AEER		6.99	6.94
Heating	Rated capacity	kw	272.0	277.5
	Rated capacity	kBtu/h	928.10	946.87
	Rated power input	kW	75.45	78.21
	Max. power input	kW	121.60	123.65
	Rated current	A	131.20	136.00
	Max. current	A	202.46	205.88
	COP		3.60	3.54
	ACOP		4.34	4.20
Compressor	Brand		MITSUBISHI ELECTRIC	MITSUBISHI ELECTRIC
	Model		ANB66FZXMT*2+ANB66FZXMT*2 +ANB66FZXMT*2+ANB66FZXMT*2	ANB66FZXMT*2+ANB66FZXMT*2 +ANB66FZXMT*2+ANB78FZXMT*2
	Type		DC INV. SCROLL	DC INV. SCROLL
	Compressor quantity		8INV	8INV
	Capacity	W	21300*2+21300*2 +21300*2+21300*2	21300*2+21300*2 +21300*2+25200*2
	Power Input	W	6600*2+6600*2+6600*2+6600*2	6600*2+6600*2+6600*2+7700*2
	Rated current(RLA)	A	21.5*2+21.5*2+21.5*2+21.5*2	21.5*2+21.5*2+21.5*2+26*2
	Speed	rps	60	60
	Crankcase Heater	W	132+132+132+132	132+132+132+132
	Refrigerant oil brand		IDEMITSUKOSAN CO.,LTD	IDEMITSUKOSAN CO.,LTD
	Refrigerant oil type		FVC68D	FVC68D
	Refrigerant oil charge	ml	(2300+1500)*2+(2300+1500)*2 +(2300+1500)*2+(2300+1500)*2	(2300+1500)*2+(2300+1500)*2 +(2300+1500)*2+(2300+1500)*2
Outdoor fan motor	Brand		BROAD-OCEAN	BROAD-OCEAN
	Model		(ZWK924D500002 +ZWK924D500002)*4	(ZWK924D500002 +ZWK924D500002)*4
	Voltage		DC540V	DC540V
	IP Class		IP44	IP44
	Type/quantity		DC/2+DC/2+DC/2+DC/2	DC/2+DC/2+DC/2+DC/2
	Insulation class		B	B
	Safe class		I	I
	Power Input	W	2320+2320+2320+2320	2320+2320+2320+2320
	Output	W	1800+1800+1800+1800	1800+1800+1800+1800
	Rated current	A	8+8+8+8	8+8+8+8
	Capacitor	μF	/	/
	Speed	rpm	0~1180	0~1180

Model			AV96NMVETA	AV98NMVETA	
Outdoor fan	Brand		Tian Da+Tian Da+Tian Da+Tian Da	Tian Da+Tian Da+Tian Da+Tian Da	
	Model		/	/	
	Material		ABS+20%GF	ABS+20%GF	
	Type		Axial	Axial	
	Diameter	mm	Φ642+Φ642+Φ642+Φ642	Φ642+Φ642+Φ642+Φ642	
	Height	mm	198+198+198+198	198+198+198+198	
Outdoor coil	Number of rows		3+3+3+3	3+3+3+3	
	Tube pitch(a)x row pitch(b)	mm	21×18.186	21×18.186	
	Fin spacing	mm	1.6	1.6	
	Fin type(code)		21×18.186	21×18.186	
	Fin coating Type	Optional	1.6	1.6	
	Salt Spray Test Duration	Hour	168	168	
	Tube outside dia.and type	mm		INNERGROOVE TUBE	INNERGROOVE TUBE
				Φ7	Φ7
Coil length x height	mm	(2843*1260+2757*1260+2669*1260)+(2843*1260+2757*1260+2669*1260)+(2843*1260+2757*1260+2669*1260)+(2843*1260+2757*1260+2669*1260)	(2843*1260+2757*1260+2669*1260)+(2843*1260+2757*1260+2669*1260)+(2843*1260+2757*1260+2669*1260)+(2843*1260+2757*1260+2669*1260)		
Number or circuits		29	29		
Cabinet coating	Coating type		Powerr Coating	Powerr Coating	
	Salt Spray Test Duration	Hour	72	72	
	Sheet Metal Material		Hot zinc plate	Hot zinc plate	
	Sheet Metal Thickness	mm	1	1	
Control panel enclosure IP class	standard		IP24	IP24	
Outdoor air flow (cooling/heating)	m ³ /h		72000	73000	
External static pressure	Pa		110	110	
Outdoor sound level(sound power level) (H)	dB(A)		96	96	
Outdoor unit	Diamension(W*D*H)	mm	1410/750/1690+1410/750/1690+1410/750/1690+1410/750/1690	1410/750/1690+1410/750/1690+1410/750/1690+1410/750/1690	
	Packing(W*D*H)	mm	1515/850/1858+1515/850/1858+1515/850/1858+1515/850/1858	1515/850/1858+1515/850/1858+1515/850/1858+1515/850/1858	
	Net weight	kg	385+385+385+385	385+385+385+385	
	Gross weight	kg	410+410+410+410	410+410+410+410	
Refrigerant	Type		R410A	R410A	
	Charged volume	kg	80	80	
Throttle type			EXV	EXV	
Design pressure		Mpa	4.15	4.15	

Model			AV96NMVETA	AV98NMVETA
Frigerant piping	Liquid pipe	mm	25.4	25.4
	Gas pipe	mm	50.8	54.1
	Oil pipe	mm	/	/
	Total pipe length	m	1000	1000
	Max. pipe length(Equivalent/Actual)	m	260/220	260/220
	Max. Diff. indoor/outdoor unit*1	m	110/90	110/90
	Standard Diff. indoor/outdoor unit	m	50/40	50/40
	Max./standard Diff. indoor/indoor unit*1	m	30/18	30/18
Connectable indoor unit ratio		%	50~130	50~130
Maximum indoor units		Piece	64	64
Connection wiring	Max. fuse current	A	252.00	252.00
	Min. wiring current	A	196.40	203.10
	Power wiring	mm ²	25+25+25+25	25+25+25+25
	Signal wiring	mm ²	2×0.75	2×0.75
Operation Range		°C	Cooling:-5~52 Heating:-27~21	Cooling:-5~52 Heating:-27~21

Nominal condition: indoor temperature (cooling): 27°C DB/19°C WB, indoor temperature (heating): 20°C DB/14.5°C WB.

Outdoor temperature(cooling): 35°C DB/24°C WB, outdoor temperature(heating): 7°C DB/6°C WB The data is measured with 7.5m equivalent pipe and 0 m height difference.

The noise level will be measured in the third octave band limited values in the semi-anechoic chamber, using a Real Time Analyser calibrated sound intensity meter. It is a sound pressure noise level.

*1 If the total pipe length is from 500 to 1000m or the height difference between the outdoor and indoor units is from 50 to 110m or the height difference between the indoor units is from 18 to 30m, you Must contact your local distributor/dealer for individual design and production.

Model			AV100NMVETA	AV102NMVETA
HP			100	102
Combination			24+24+26+26	24+26+26+26
Power supply		Ph/V/Hz	3/380~415/50/60	3/380~415/50/60
Cooling	Rated capacity	kW	283.0	288.5
	Rated capacity	kBtu/h	965.64	984.40
	Rated power input	kW	79.71	82.35
	Max. power input	kW	136.32	138.86
	Rated current	A	134.57	139.02
	Max. current	A	225.96	230.69
	EER		3.55	3.50
	AEER		6.89	6.84
Heating	Rated capacity	kw	283.0	288.5
	Rated capacity	kBtu/h	965.64	984.40
	Rated power input	kW	80.97	83.73
	Max. power input	kW	125.70	127.75
	Rated current	A	140.80	145.60
	Max. current	A	209.29	212.70
	COP		3.49	3.44
	ACOP		4.08	3.98
Compressor	Brand		MITSUBISHI ELECTRIC	MITSUBISHI ELECTRIC
	Model		ANB66FZXMT*2+ANB66FZXMT*2+ANB78FZXMT*2+ANB78FZXMT*2	ANB66FZXMT*2+ANB78FZXMT*2+ANB78FZXMT*2+ANB78FZXMT*2
	Type		DC INV. SCROLL	DC INV. SCROLL
	Compressor quantity		8INV	8INV
	Capacity	W	21300*2+21300*2+25200*2+25200*2	21300*2+25200*2+25200*2+25200*2
	Power Input	W	6600*2+6600*2+7700*2+7700*2	6600*2+7700*2+7700*2+7700*2
	Rated current(RLA)	A	21.5*2+21.5*2+26*2+26*2	21.5*2+26*2+26*2+26*2
	Speed	rps	60	60
	Crankcase Heater	W	132+132+132+132	132+132+132+132
	Refrigerant oil brand		IDEMITSUKOSAN CO.,LTD	IDEMITSUKOSAN CO.,LTD
	Refrigerant oil type		FVC68D	FVC68D
	Refrigerant oil charge	ml	(2300+1500)*2+(2300+1500)*2+(2300+1500)*2+(2300+1500)*2	(2300+1500)*2+(2300+1500)*2+(2300+1500)*2+(2300+1500)*2
Outdoor fan motor	Brand		BROAD-OCEAN	BROAD-OCEAN
	Model		(ZWK924D500002+ZWK924D500002)*4	(ZWK924D500002+ZWK924D500002)*4
	Voltage		DC540V	DC540V
	IP Class		IP44	IP44
	Type/quantity		DC/2+DC/2+DC/2+DC/2	DC/2+DC/2+DC/2+DC/2
	Insulation class		B	B
	Safe class		I	I
	Power Input	W	2320+2320+2320+2320	2320+2320+2320+2320
	Output	W	1800+1800+1800+1800	1800+1800+1800+1800
	Rated current	A	8+8+8+8	8+8+8+8
	Capacitor	μF	/	/
	Speed	rpm	0~1180	0~1180

Model			AV100NMVETA	AV102NMVETA	
Outdoor fan	Brand		Tian Da+Tian Da+Tian Da+Tian Da	Tian Da+Tian Da+Tian Da+Tian Da	
	Model		/	/	
	Material		ABS+20%GF	ABS+20%GF	
	Type		Axial	Axial	
	Diameter	mm	Φ642+Φ642+Φ642+Φ642	Φ642+Φ642+Φ642+Φ642	
	Height	mm	198+198+198+198	198+198+198+198	
Outdoor coil	Number of rows		3+3+3+3	3+3+3+3	
	Tube pitch(a)x row pitch(b)	mm	21×18.186	21×18.186	
	Fin spacing	mm	1.6	1.6	
	Fin type(code)		21×18.186	21×18.186	
	Fin coating Type	Optional	1.6	1.6	
	Salt Spray Test Duration	Hour	168	168	
	Tube outside dia.and type	mm		INNERGROOVE TUBE	INNERGROOVE TUBE
				Φ7	Φ7
Coil length x height	mm	(2843*1260+2757*1260+2669*1260)+(2843*1260+2757*1260+2669*1260)+(2843*1260+2757*1260+2669*1260)+(2843*1260+2757*1260+2669*1260)	(2843*1260+2757*1260+2669*1260)+(2843*1260+2757*1260+2669*1260)+(2843*1260+2757*1260+2669*1260)+(2843*1260+2757*1260+2669*1260)		
Number or circuits		29	29		
Cabinet coating	Coating type		Powerr Coating	Powerr Coating	
	Salt Spray Test Duration	Hour	72	72	
	Sheet Metal Material		Hot zinc plate	Hot zinc plate	
	Sheet Metal Thickness	mm	1	1	
Control panel enclosure IP class	standard		IP24	IP24	
Outdoor air flow (cooling/heating)	m ³ /h		74000	75000	
External static pressure	Pa		110	110	
Outdoor sound level(sound power level) (H)	dB(A)		96	96	
Outdoor unit	Diamension(W*D*H)	mm	1410/750/1690+1410/750/1690+1410/750/1690+1410/750/1690	1410/750/1690+1410/750/1690+1410/750/1690+1410/750/1690	
	Packing(W*D*H)	mm	1515/850/1858+1515/850/1858+1515/850/1858+1515/850/1858	1515/850/1858+1515/850/1858+1515/850/1858+1515/850/1858	
	Net weight	kg	385+385+385+385	385+385+385+385	
	Gross weight	kg	410+410+410+410	410+410+410+410	
Refrigerant	Type		R410A	R410A	
	Charged volume	kg	80	80	
Throttle type			EXV	EXV	
Design pressure		Mpa	4.15	4.15	

Model			AV100NMVETA	AV102NMVETA
Frigerant piping	Liquid pipe	mm	25.4	25.4
	Gas pipe	mm	54.1	54.1
	Oil pipe	mm	/	/
	Total pipe length	m	1000	1000
	Max. pipe length(Equivalent/Actual)	m	260/220	260/220
	Max. Diff. indoor/outdoor unit*1	m	110/90	110/90
	Standard Diff. indoor/outdoor unit	m	50/40	50/40
	Max./standard Diff. indoor/indoor unit*1	m	30/18	30/18
Connectable indoor unit ratio		%	50~130	50~130
Maximum indoor units		Piece	64	64
Connection wiring	Max. fuse current	A	252.00	252.00
	Min. wiring current	A	209.80	216.50
	Power wiring	mm ²	25+25+25+25	25+25+25+25
	Signal wiring	mm ²	2×0.75	2×0.75
Operation Range		°C	Cooling:-5~52 Heating:-27~21	Cooling:-5~52 Heating:-27~21

Nominal condition: indoor temperature (cooling): 27°C DB/19°C WB, indoor temperature (heating): 20°C DB/14.5°C WB.

Outdoor temperature(cooling): 35°C DB/24°C WB, outdoor temperature(heating): 7°C DB/6°C WB The data is measured with 7.5m equivalent pipe and 0 m height difference.

The noise level will be measured in the third octave band limited values in the semi-anechoic chamber, using a Real Time Analyser calibrated sound intensity meter. It is a sound pressure noise level.

*1 If the total pipe length is from 500 to 1000m or the height difference between the outdoor and indoor units is from 50 to 110m or the height difference between the indoor units is from 18 to 30m, you Must contact your local distributor/dealer for individual design and production.

Model		AV104NMVETA	
HP		104	
Combination		26+26+26+26	
Power supply		Ph/V/Hz	3/380~415/50/60
Cooling	Rated capacity	kW	294.0
	Rated capacity	kBtu/h	1003.17
	Rated power input	kW	84.98
	Max. power input	kW	141.40
	Rated current	A	143.47
	Max. current	A	235.43
	EER		3.46
	AEER		6.80
Heating	Rated capacity	kw	294.0
	Rated capacity	kBtu/h	1003.17
	Rated power input	kW	86.50
	Max. power input	kW	129.80
	Rated current	A	150.40
	Max. current	A	216.12
	COP		3.39
	ACOP		3.88
Compressor	Brand	MITSUBISHI ELECTRIC	
	Model	ANB78FZXMT*2+ANB78FZXMT*2 +ANB78FZXMT*2+ANB78FZXMT*2	
	Type	DC INV. SCROLL	
	Compressor quantity	8INV	
	Capacity	W	25200*2+25200*2+25200*2+25200*2
	Power Input	W	7700*2+7700*2+7700*2+7700*2
	Rated current(RLA)	A	26*2+26*2+26*2+26*2
	Speed	rps	60
	Crankcase Heater	W	132+132+132+132
	Refrigerant oil brand	IDEMITSUKOSAN CO.,LTD	
	Refrigerant oil type	FVC68D	
	Refrigerant oil charge	ml	(2300+1500)*2+(2300+1500)*2 +(2300+1500)*2+(2300+1500)*2
Outdoor fan motor	Brand	BROAD-OCEAN	
	Model	(ZWK924D500002+ZWK924D500002)*4	
	Voltage	DC540V	
	IP Class	IP44	
	Type/quantity	DC/2+DC/2+DC/2+DC/2	
	Insulation class	B	
	Safe class	I	
	Power Input	W	2320+2320+2320+2320
	Output	W	1800+1800+1800+1800
	Rated current	A	8+8+8+8
	Capacitor	μF	/
	Speed	rpm	0~1180

Model		AV104NMVETA	
Outdoor fan	Brand		Tian Da+Tian Da+Tian Da+Tian Da
	Model		/
	Material		ABS+20%GF
	Type		Axial
	Diameter	mm	Φ642+Φ642+Φ642+Φ642
	Height	mm	198+198+198+198
Outdoor coil	Number of rows		3+3+3+3
	Tube pitch(a)x row pitch(b)	mm	21×18.186
	Fin spacing	mm	1.6
	Fin type(code)		21×18.186
	Fin coating Type	Optional	1.6
	Salt Spray Test Duration	Hour	168
	Tube outside dia.and type	mm	INNERGROOVE TUBE Φ7
	Coil length x height	mm	(2843*1260+2757*1260+2669*1260) +(2843*1260+2757*1260+2669*1260) +(2843*1260+2757*1260+2669*1260) +(2843*1260+2757*1260+2669*1260)
Number or circuits		29	
Cabinet coating	Coating type		Powerr Coating
	Salt Spray Test Duration	Hour	72
	Sheet Metal Material		Hot zinc plate
	Sheet Metal Thickness	mm	1
Control panel enclosure IP class	standard		IP24
Outdoor air flow (cooling/heating)	m ³ /h		76000
External static pressure	Pa		110
Outdoor sound level(sound power level) (H)	dB(A)		96
Outdoor unit	Diamension(W*D*H)	mm	1410/750/1690+1410/750/1690 +1410/750/1690+1410/750/1690
	Packing(W*D*H)	mm	1515/850/1858+1515/850/1858 +1515/850/1858+1515/850/1858
	Net weight	kg	385+385+385+385
	Gross weight	kg	410+410+410+410
Refrigerant	Type		R410A
	Charged volume	kg	80
Throttle type			EXV
Design pressure	Mpa		4.15

Model			AV104NMVETA
Frigerant piping	Liquid pipe	mm	25.4
	Gas pipe	mm	54.1
	Oil pipe	mm	/
	Total pipe length	m	1000
	Max. pipe length(Equivalent/Actual)	m	260/220
	Max. Diff. indoor/outdoor unit*1	m	110/90
	Standard Diff. indoor/outdoor unit	m	50/40
	Max./standard Diff. indoor/indoor unit*1	m	30/18
Connectable indoor unit ratio		%	50~130
Maximum indoor units		Piece	64
Connection wiring	Max. fuse current	A	252.00
	Min. wiring current	A	223.20
	Power wiring	mm ²	25+25+25+25
	Signal wiring	mm ²	2×0.75
Operation Range		°C	Cooling:-5~52 Heating:-27~21

Nominal condition: indoor temperature (cooling): 27°C DB/19°C WB, indoor temperature (heating): 20°C DB/14.5°C WB.

Outdoor temperature(cooling): 35°C DB/24°C WB, outdoor temperature(heating): 7°C DB/6°C WB The data is measured with 7.5m equivalent pipe and 0 m height difference.

The noise level will be measured in the third octave band limited values in the semi-anechoic chamber, using a Real Time Analyser calibrated sound intensity meter. It is a sound pressure noise level.

*1 If the total pipe length is from 500 to 1000m or the height difference between the outdoor and indoor units is from 50 to 110m or the height difference between the indoor units is from 18 to 30m, you Must contact your local distributor/dealer for individual design and production.

4. Dimension

AV08/10/12/14/16NMVETA

Unit:mm (inch)

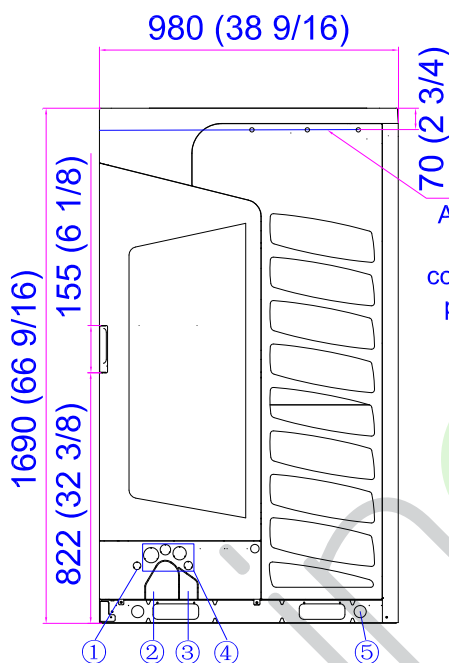
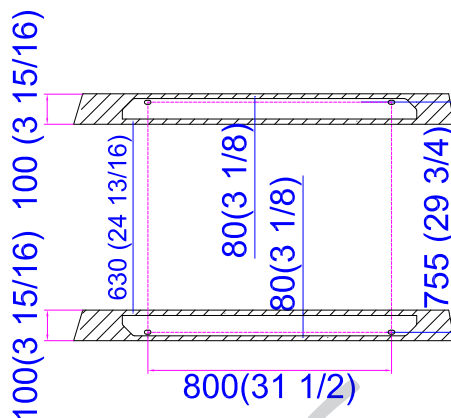
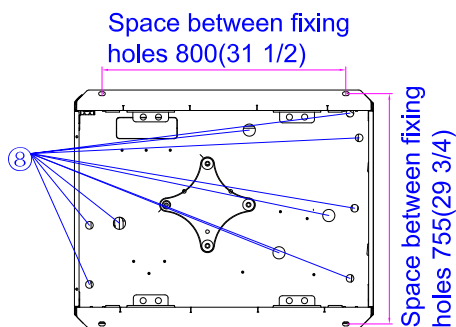

Air outlet duct connection position

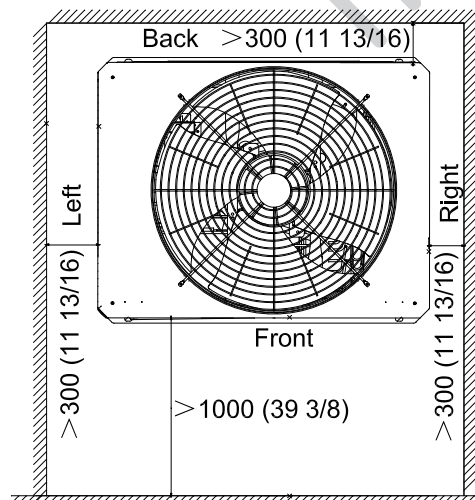
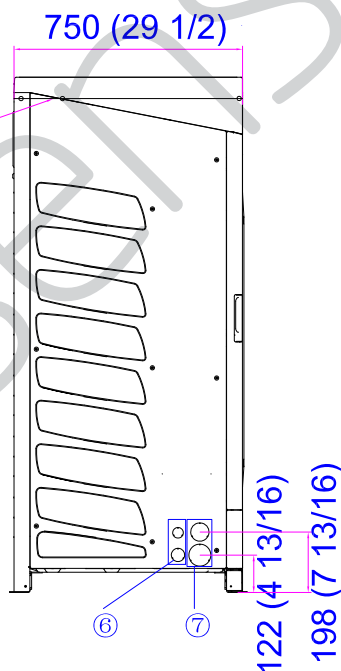

No.	Name	Remark
①	Signal line hole (Ø25)	Using the rubber plug in the unit's attachment for protection
②	Pipe outlet for 2-pipe system	
③	Pipe outlet for 3-pipe system	
④	Power supply hole (Ø50 / Ø35)	According to the wire diameter size to choose the appropriate line hole, and using the line sheath in the unit's attachment for protection.
⑤	Hoisting hole (Ø40)	
⑥	Power supply of signal line hole (Ø35 / Ø44)	
⑦	Refrigerant pipe outlet (Ø60 / Ø72)	
⑧	Drain hole	

AV18/20/22/24/26NMVETA

Unit:mm (inch)

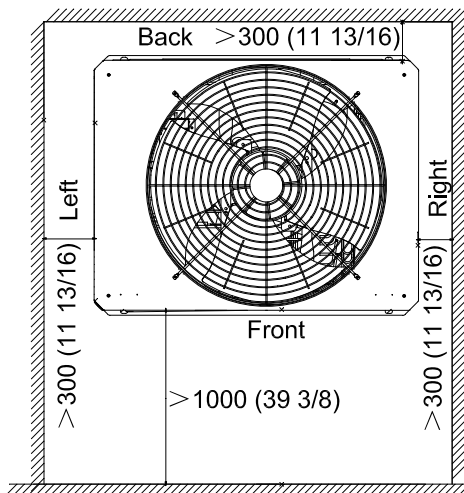
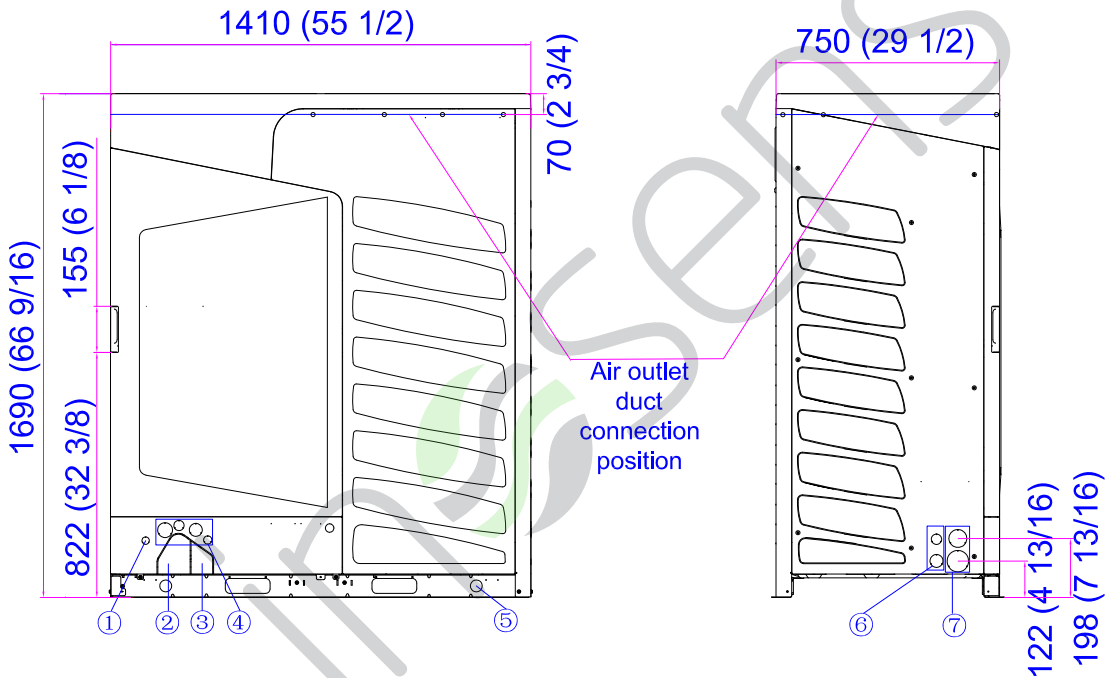
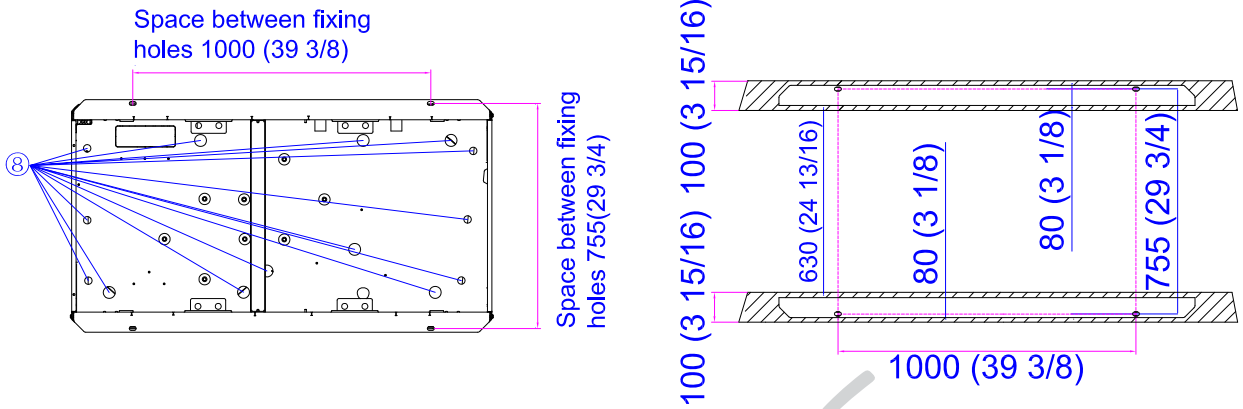

No.	Name	Remark
①	Signal line hole (Ø25)	Using the rubber plug in the unit's attachment for protection
②	Pipe outlet for 2-pipe system	
③	Pipe outlet for 3-pipe system	
④	Power supply hole (Ø50 / Ø35)	According to the wire diameter size to choose the appropriate line hole, and using the line sheath in the unit's attachment for protection.
⑤	Hoisting hole (Ø40)	
⑥	Power supply of signal line hole (Ø35 / Ø44)	
⑦	Refrigerant pipe outlet (Ø60 / Ø72)	
⑧	Drain hole	

5. Center of gravity

AV08/10/12/14/16NMVETA

Coordinate position (x, y, z: 471, 375, 725)

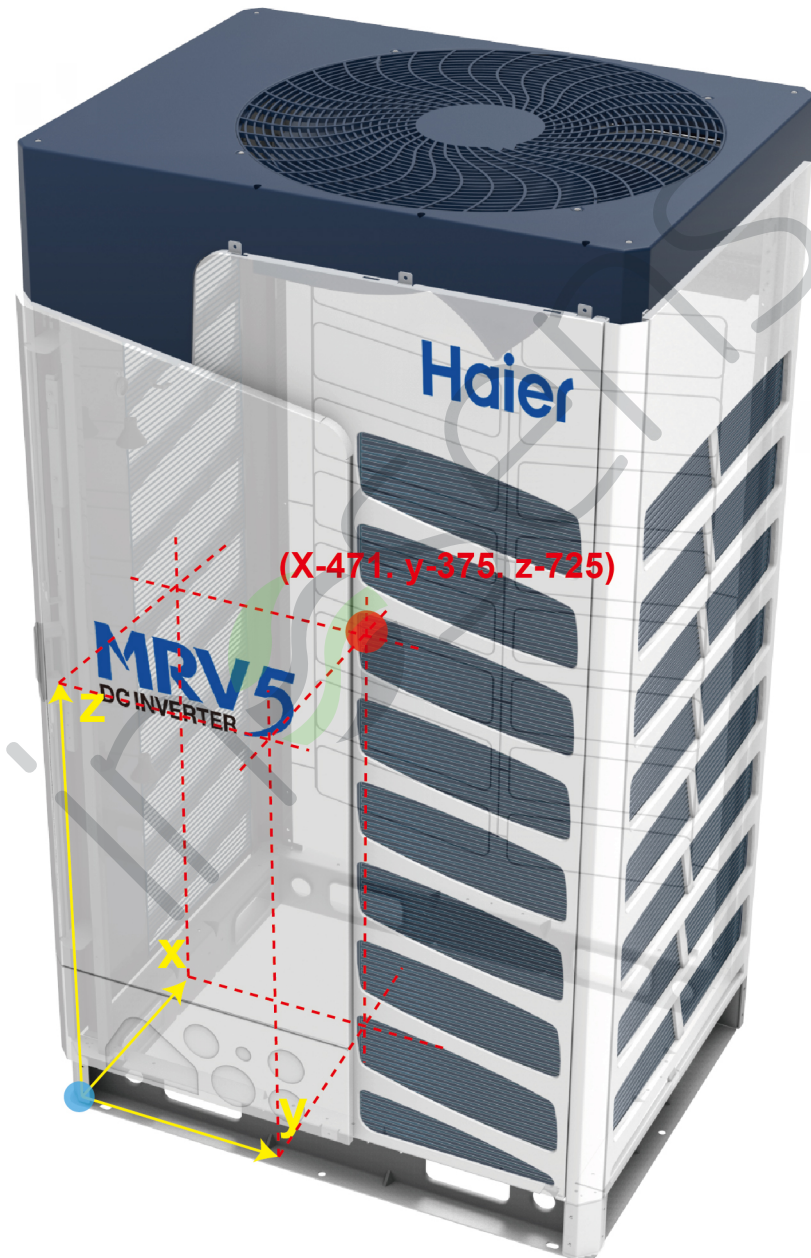

AV18/20/22/24/26NMVETA

Coordinate position (x, y, z: 650, 380, 706)

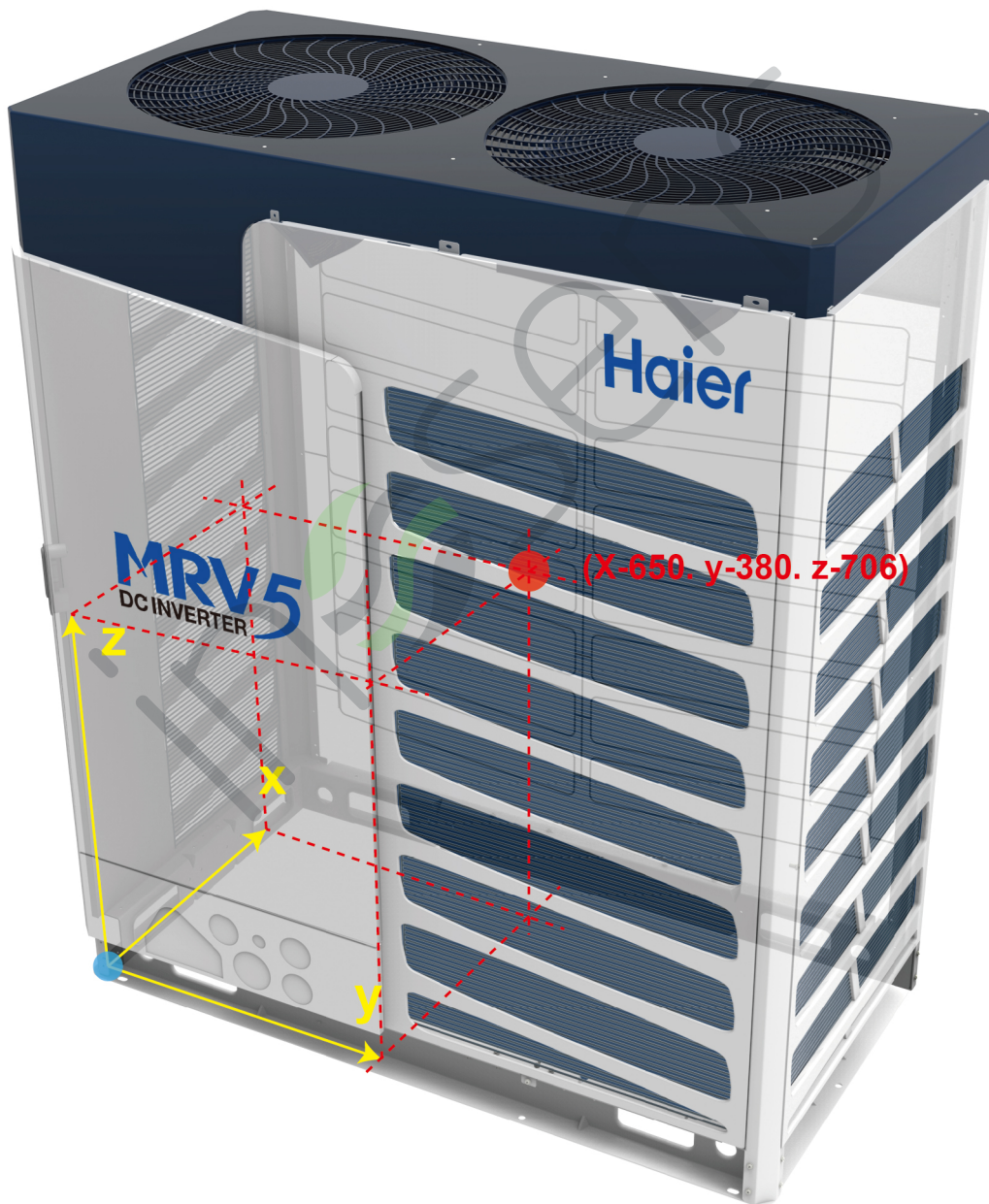

6. Piping diagram

AV08/10/12/14/16NMVETA

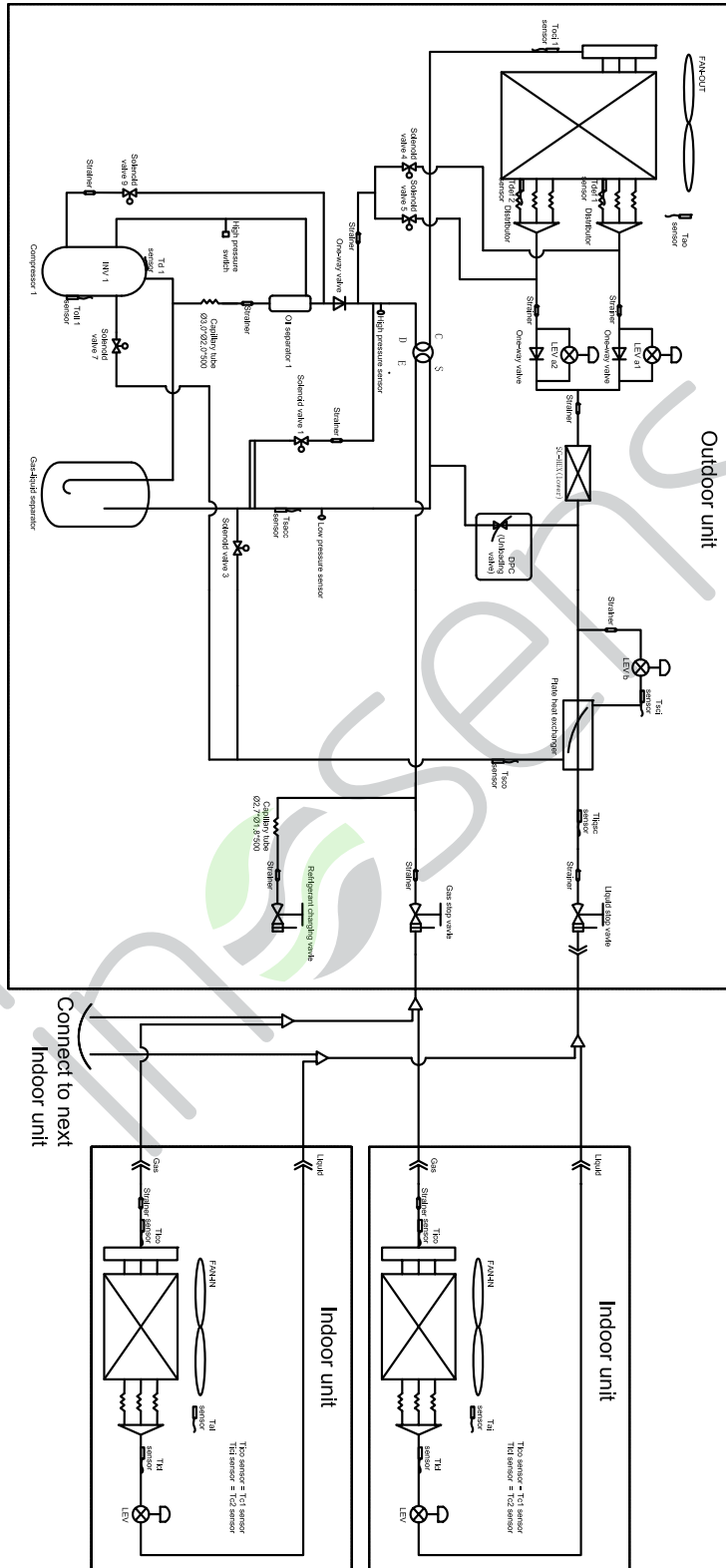

AV18/20/22/24/26NMVETA

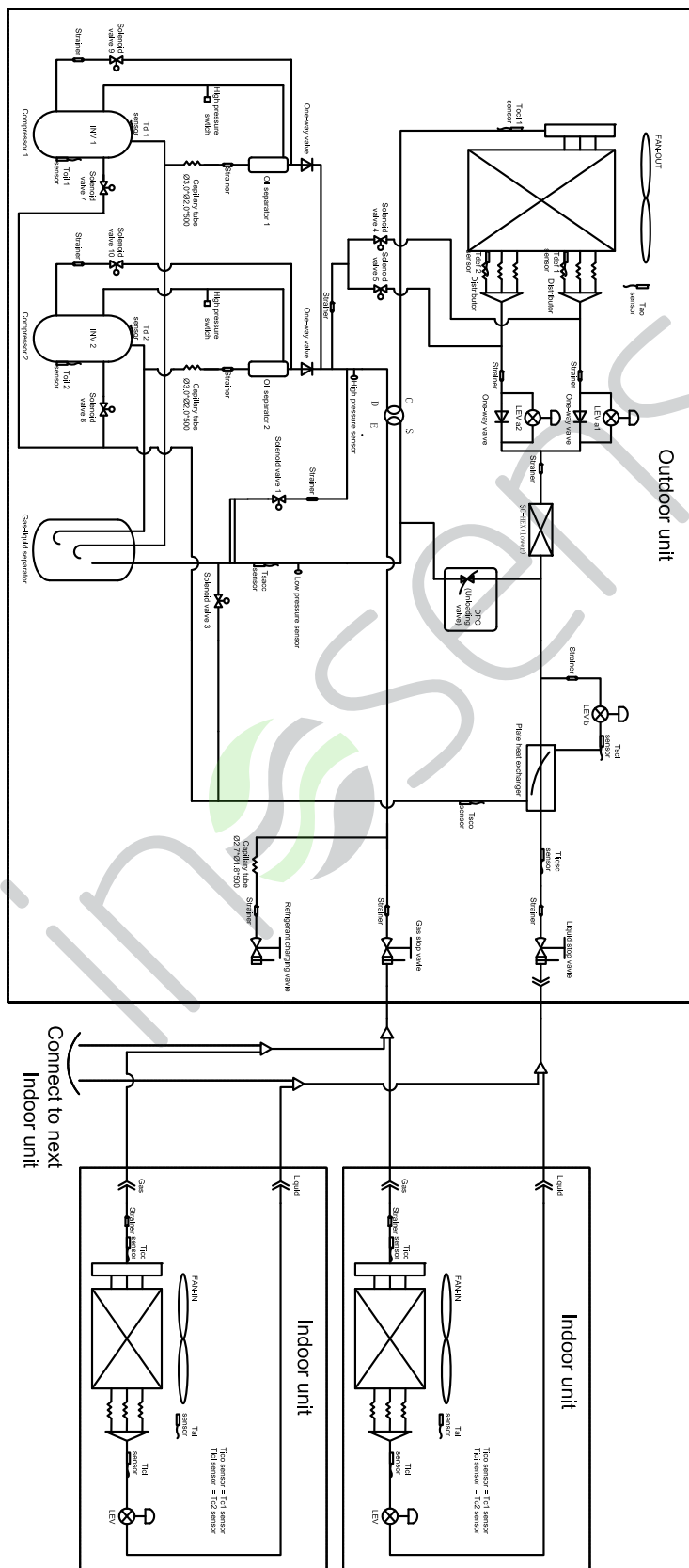

Part name	Sign	Function	Data	Remark
Compressor	/	Capacity control, to meet indoor load through frequency adjustment.	ANB52FZJMT: 0.31Ω	20°C
			ANB66FZXMT: 0.23Ω	
			ANB78FZXMT: 0.23Ω	
Pressure switch	HPS1/i	Protection control for high pressure.	4.15Mpa, OFF setting	
Pressure sensor	PD	In heating, compressor frequency adjustment and protection control for abnormal pressure.	0~4.15MPa.	
	PS	In cooling, compressor frequency adjustment and protection control for abnormal pressure.	0~1.7MPa.	
Electronic expansion valve	LEVA1, 2	Refrigerant flow control in heating.	HAM-BD30SM-2	
Solenoid valve	SV1	1. Balance between high and low pressures when the compressor starts and stops; 2. Protection to prevent high and low pressures.	AC220V	2A
	SV3	Started when the compressor discharging temperature and oil temperature are too high to carry out temperature reduction by refrigerant spraying.	AC220V	6A
	SV4	In the heating mode, the high pressure side refrigerant is bypassed to the condenser for frosting	AC220V	6A
	SV5		AC220V	6A
	SV7	Enhanced vapor injection of compressor 1	AC220V	6A
	SV8	Enhanced vapor injection of compressor 2	AC220V	6A
	SV10	Outdoor unit SV10 for oil suction starts during oil balance; for pressure relief to prevent explosion of pipe group.	AC220V	2A
	SV9	The outdoor unit for oil discharging starts SV9 for oil balancing during oil balance among modules.	AC220V	2A
Four-way valve	4WV	Switch between cooling and heating.	AC220V Power on during heating and power off during cooling or defrosting.	
Temperature sensor	Toil1/2	To detect the temperature of refrigeration lubricant at the compressor bottom.	R (80°C) - 50K	
	Td1/Td2	To detect the top temperature of inverter/ON-OFF compressor.	B (25/80°C)=4450K	
	Tdef1/Tdef2	To detect the frosting of outdoor heat exchanger.		
	Toci1	To detect the temperature of condenser main gas pipe to control LEVa1, 2 during heating.		
	Tliqsc/Tsco	Detect SH temp. of subcooler	R(25°C)=10K,	
	Tsci	Detect SH temp. of LEVb outlet	B(25°C/50°C) =3700K	
	Tsacc	To detect the inlet temperature of gas-liquid segregator.		
	Tao	To detect ambient temperature and control the initial air speed and defrosting conditions.		
Heater	HEAT1/2	Used to heat the compressor oil in the inverter compressor.	33W, 220V, 2 pieces/ compressor.	

7. Refrigerant flow Cooling operation

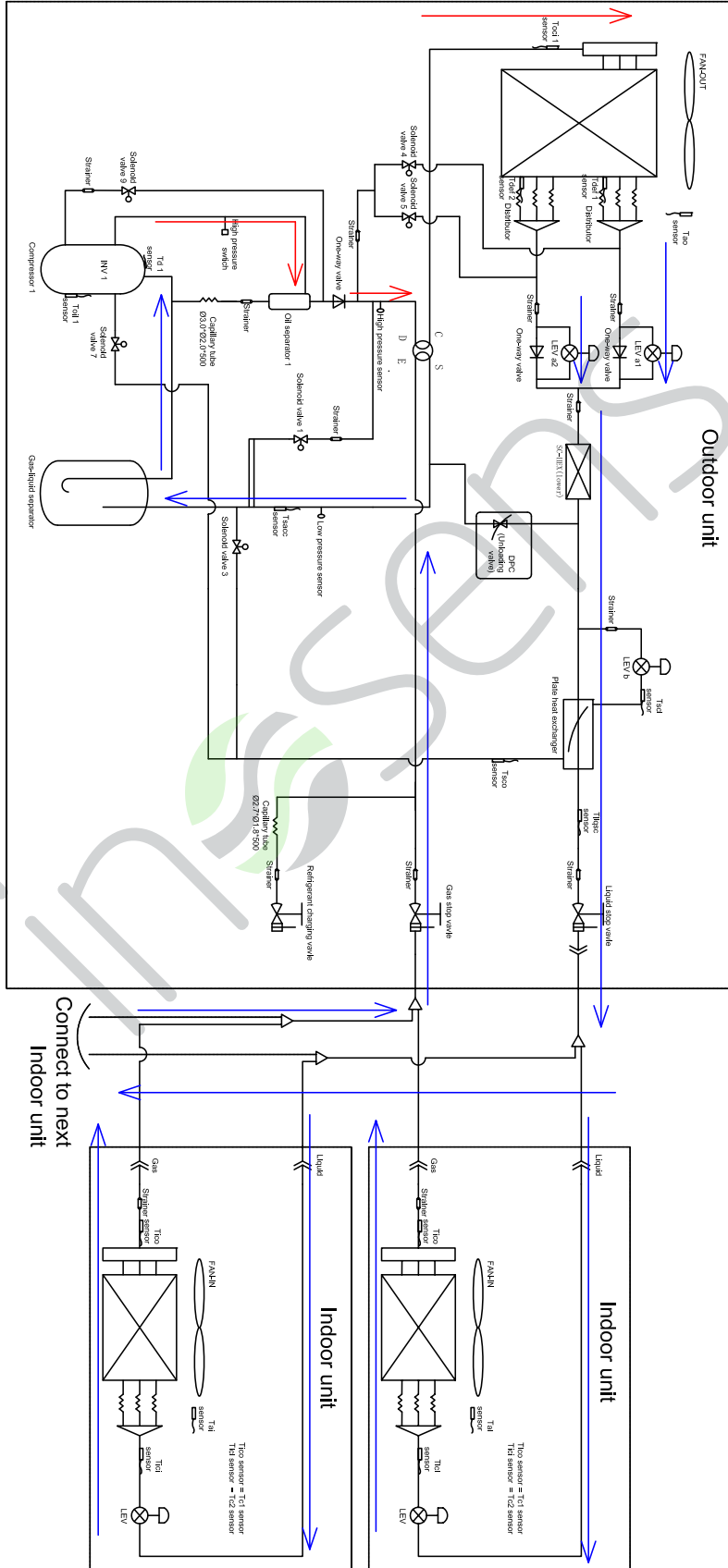

Heating operation

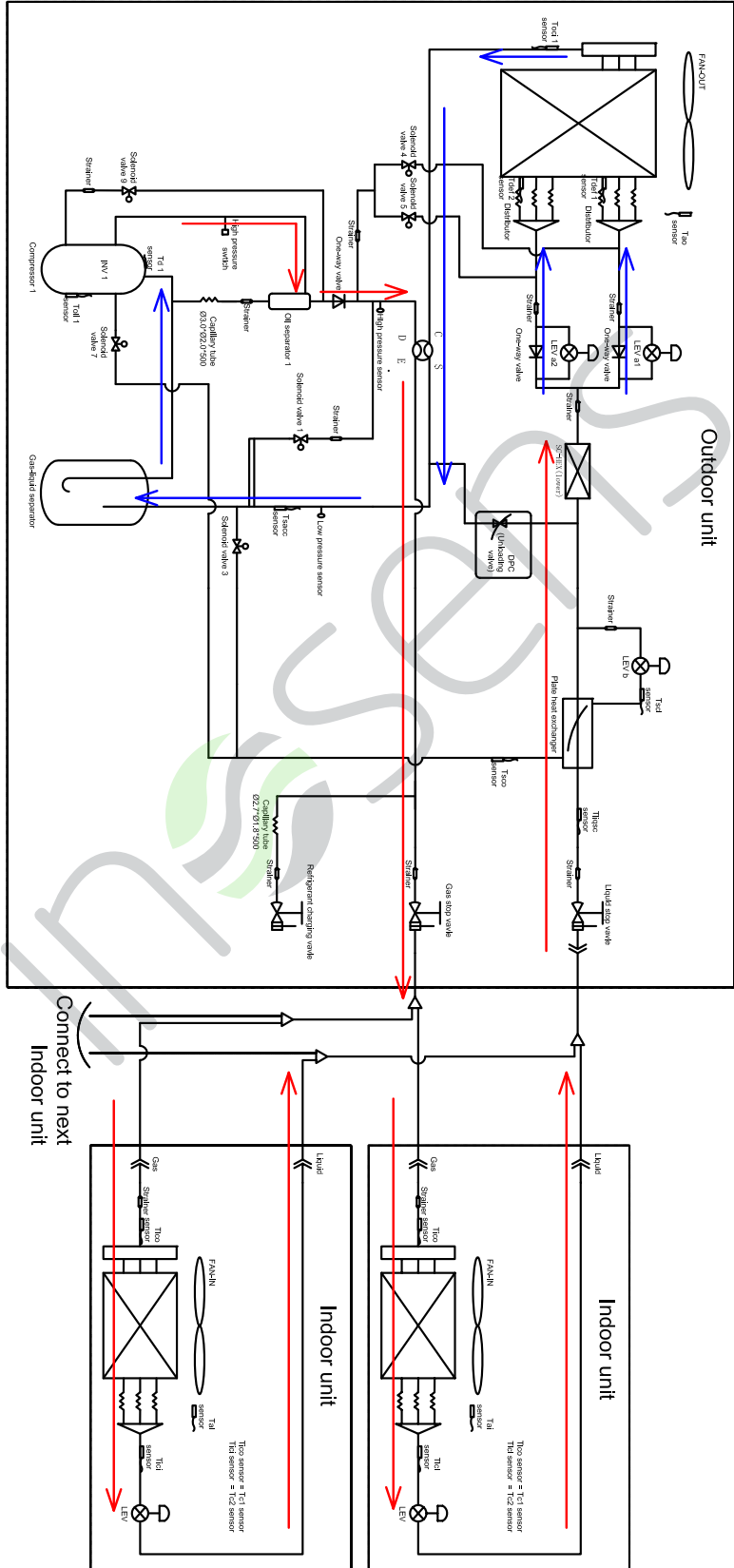

8. Functional parts layout

AV08/10/12/14/16NMVETA

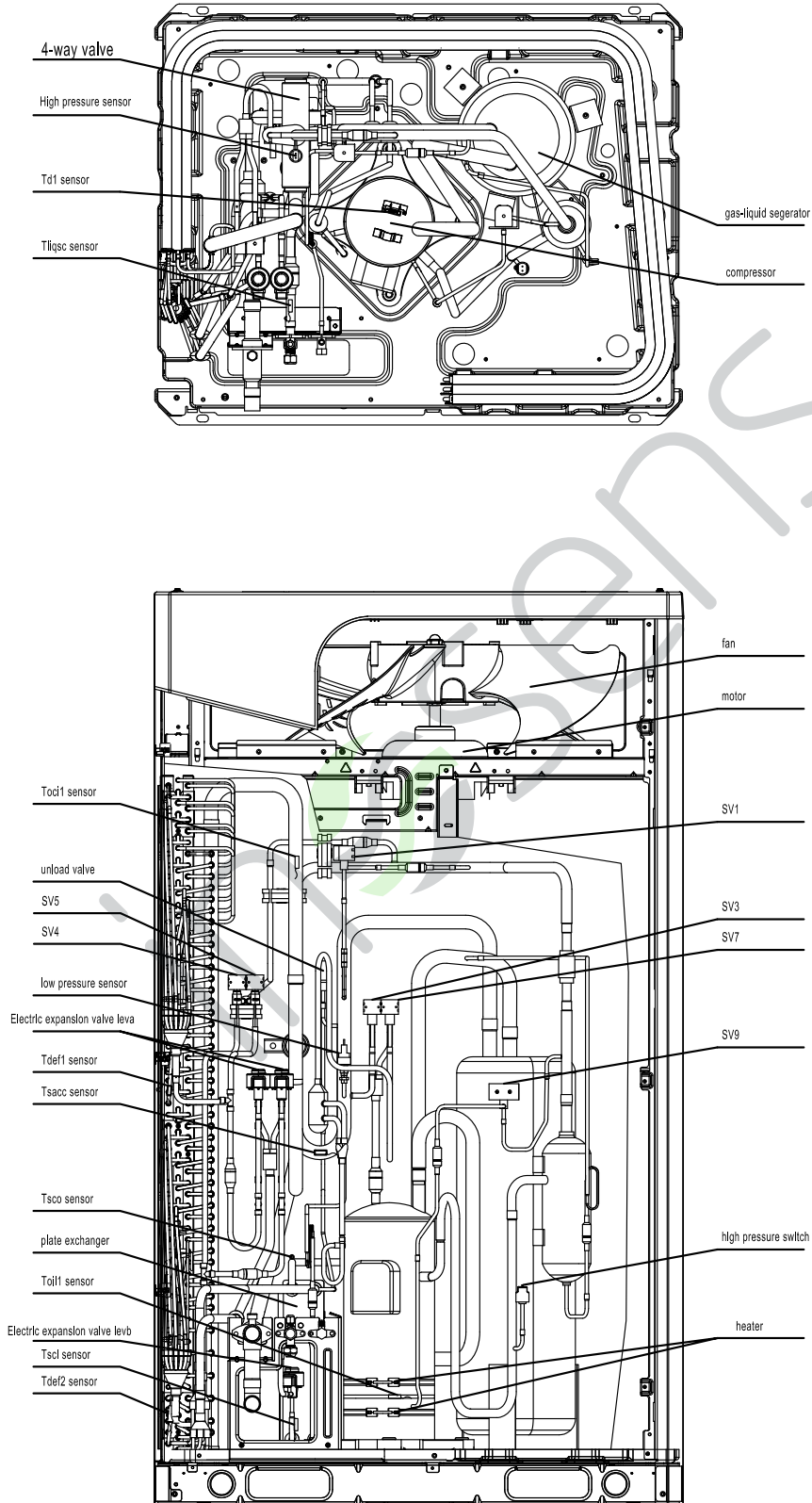

AV18/20/22/24/26NMVETA

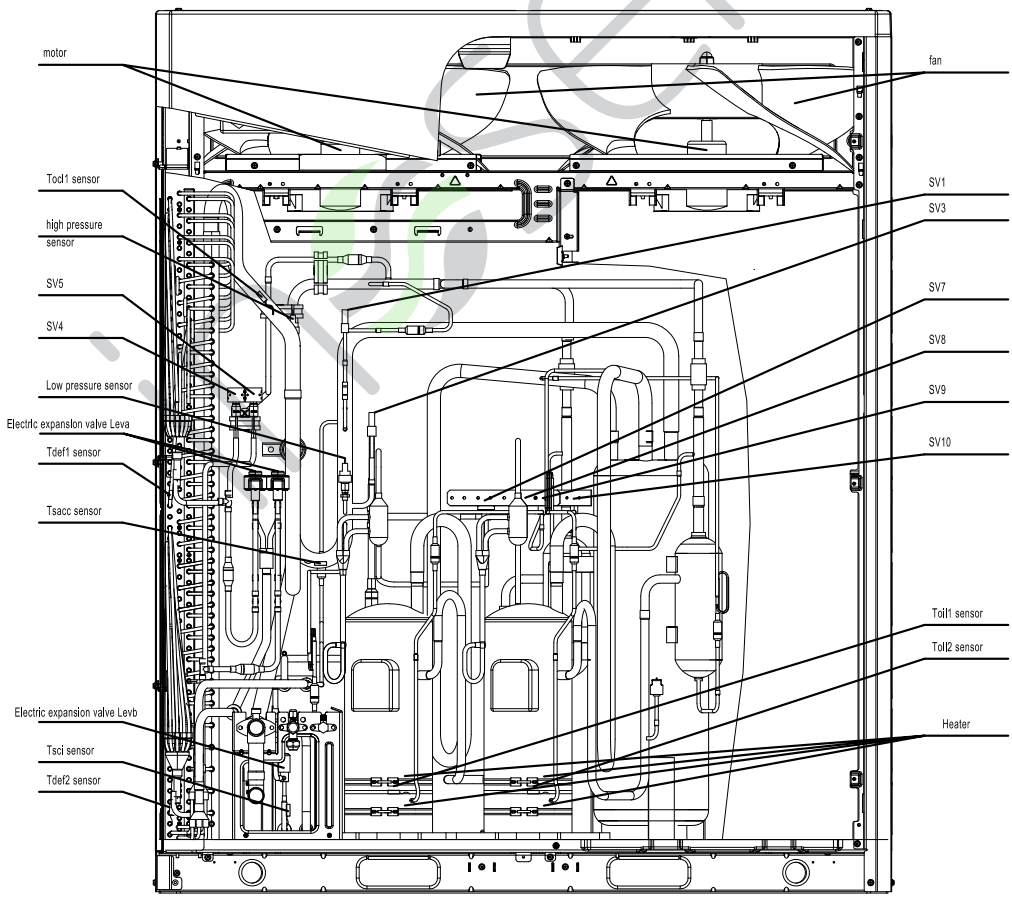
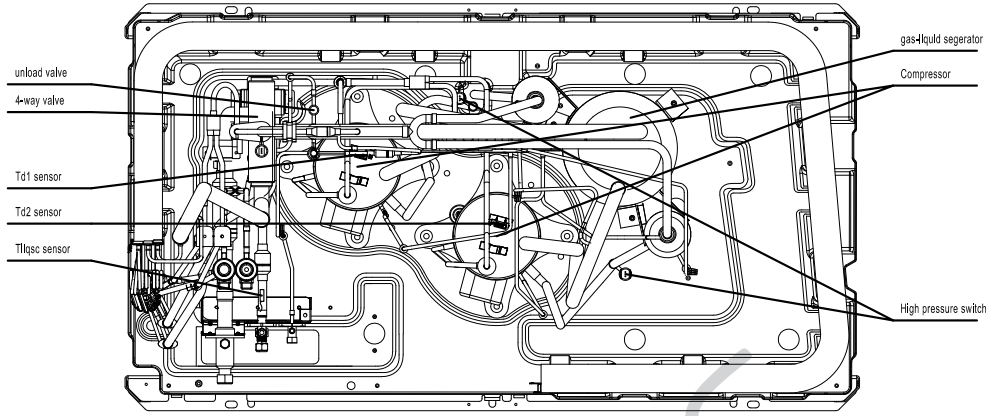

Electric control box assy. parts layout

AV08/10/12/14/16/18NMVETA

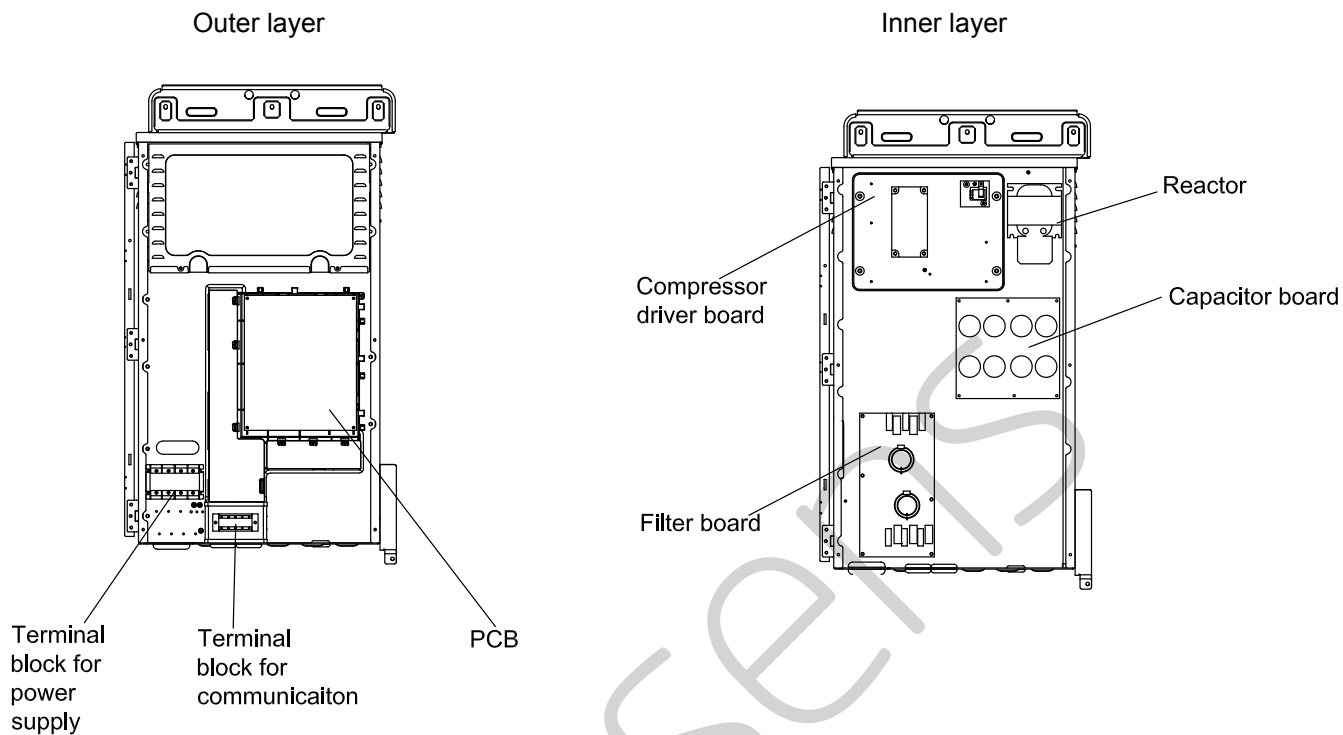

AV20/22/24/26NMVETA

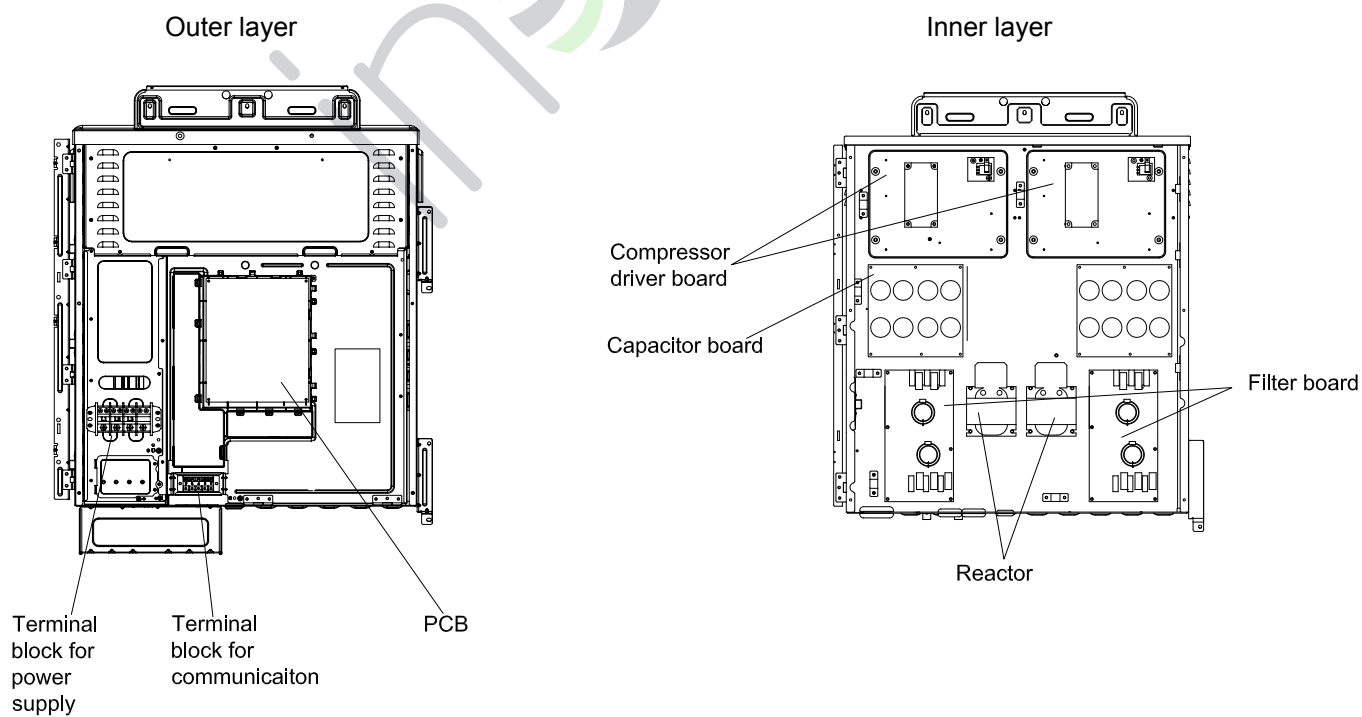

9. Wiring diagram

Description of the Main-board Port definition		Common fault code definition	
No.	Port	Port description	Fault code description
1	LING	AC Power Input	Outdoor unit motor unit communication failure
2	S10	Liquid injection to compressor	45-01
3	S10	Drain the oil from compressor 2	45-02
4	S10	Drain the oil from compressor 1	45-03
5	S17	Balance pressure (cap/PSF)	45-04
6	J101	High and low side solenoid	45-05
7	J101	High pressure sensor	45-06
8	J101	High pressure sensor	45-07
9	J101	High pressure sensor	45-08
10	J101	High pressure sensor	45-09
11	J101	High pressure sensor	45-10
12	J101	High pressure sensor	45-11
13	J101	High pressure sensor	45-12
14	J101	High pressure sensor	45-13
15	J101	High pressure sensor	45-14
16	J101	High pressure sensor	45-15
17	J101	High pressure sensor	45-16
18	J101	High pressure sensor	45-17
19	J101	High pressure sensor	45-18
20	J101	High pressure sensor	45-19
21	J101	High pressure sensor	45-20
22	J101	High pressure sensor	45-21
23	J101	High pressure sensor	45-22
24	J101	High pressure sensor	45-23
25	J101	High pressure sensor	45-24
26	J101	High pressure sensor	45-25
27	J101	High pressure sensor	45-26
28	J101	High pressure sensor	45-27
29	J101	High pressure sensor	45-28
30	J101	High pressure sensor	45-29
31	J101	High pressure sensor	45-30
32	J101	High pressure sensor	45-31
33	J101	High pressure sensor	45-32
34	J101	High pressure sensor	45-33
35	J101	High pressure sensor	45-34
36	J101	High pressure sensor	45-35
37	J101	High pressure sensor	45-36
38	J101	High pressure sensor	45-37
39	J101	High pressure sensor	45-38
40	J101	High pressure sensor	45-39
41	J101	High pressure sensor	45-40
42	J101	High pressure sensor	45-41
43	J101	High pressure sensor	45-42
44	J101	High pressure sensor	45-43
45	J101	High pressure sensor	45-44
46	J101	High pressure sensor	45-45

Tightening torque N.m	
Globe valve size	Maintenance valve
φ6.35	5~6
φ9.52	5~6
φ12.7	13~16
φ15.88	16~20
φ19.05	20~25
φ28.58	22~27
	37.5±2.5
	20~25

Power: 3N~ , 380-415V, 50/60Hz

Description:

- The part shown in the dashed box is for double compressor models.
- Outdoor units fault code definition description, code suffix -0/1 indicates that the compressor 1/2 failure; code suffix -4/5 indicates that the fan 1/2 drive failure.

NOTE

- In the air tightness test, please separate the indoor side of the airtight test to prevent nitrogen into the outdoor unit.
- In the welding process must be nitrogen and cooling protection, to prevent oxidation of the pipeline and the valve body damage.
- Tighten the bell-shaped pipe joint nut, do not exceed the appropriate torque, otherwise it will cause leakage. Cut off the valve tightening torque as shown on the right:
- At the time of shipment, the valves are fully closed and must be confirmed that the valves and trachea valves are fully open before starting the unit.
- After repair or maintenance is completed, the service valve and cap must be tightened with the appropriate torque to prevent refrigerant leakage.

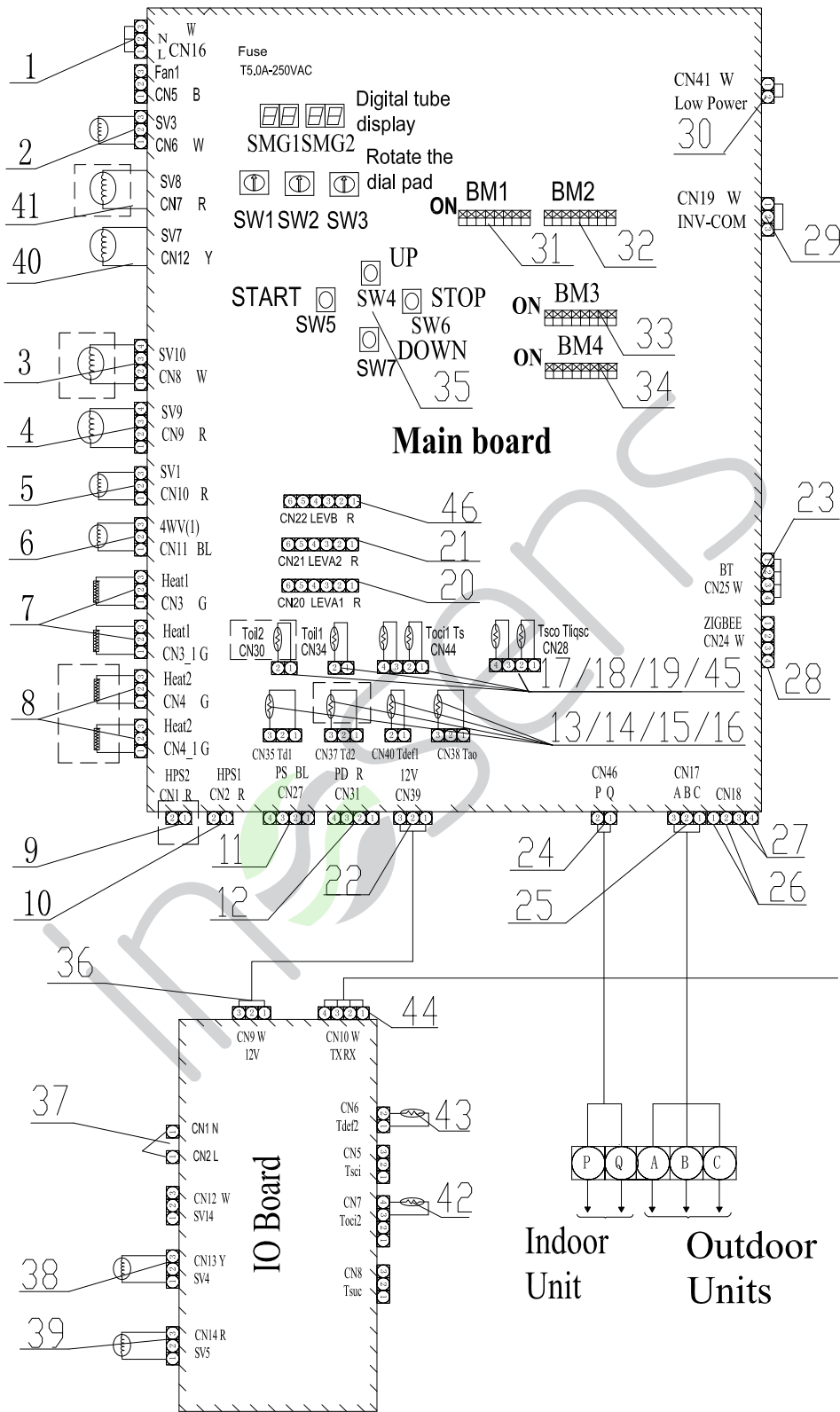

Description of the main board port definition		
No.	Port	Port description
1	L/N/G	AC Power input
2	SV3	Liquid jetting to compressor
3	SV10	Drain the oil from compressor 2
4	SV9	Drain the oil from compressor 1
5	SV1	Balance pressure(Load-OFF)
6	4WV	Hot and cold switching
7	HEAT1	Heating band of compressor 1
8	HEAT2	Heating band of compressor 2
9	HPS2	High Pressure Switch of Compressor 2
10	HPS1	High Pressure Switch of Compressor 1
11	PS	Low pressure sensor
12	PD	High pressure sensor
13	Td1	Compressor 1 exhaust temperature
14	Td2	Compressor 2 exhaust temperature
15	Tdef1	Detect the defrosting temp
16	Tao	Ambient temperature
17	Toil2	Detect the oil temp. of compressor 2
18	Toil1	Detect the oil temp. of compressor 1
19	Toci1/Ts	Detect SH temp. in heating
20	LEVA1	SH control in heating
21	LEVA2	SH control in heating
22	DC12V	Output DC12V
23	BT	Output DC5V/Communication
24	P/Q	Indoor unit and outdoor unit com. port
25	A B C	Outdoor and outdoor com. port
26	BUS-B BUS-A	Centralized control port
27	STOP	Emergency stop switch
28	ZIGBEE	Wireless module com. port
29	INV-COM	INV module com. port
30	Low Power	Low standby power consumption
31	BM1	Outdoor and indoor searching Outdoor address setting
32	BM2	Wireless communication
33	BM3	HP setting of outdoor units
34	BM4	Set the control address
35	SW4/5/6/7	Special function control keys
36	DC12V	Input DC12V
37	L/N	AC Power Input
38	SV4	Continuous heating
39	SV5	Continuous heating
40	SV7	Enhanced vapor injection of compressor 1
41	SV8	Enhanced vapor injection of compressor 2
42	Toci2	Detect SH temp. in heating
43	Tdef2	Detect the defrosting temp
44	Tx Rx	Input DC5V/Communication
45	Tliqsc/Tsco	Detect SH temp. of subcooler
46	LEVB	Control subcooler

10. Capacity calculation due to capacity modification coefficient

(1) Calculation method of cooling capacity---Refrigerating capacity to be known=Refrigerating capacity x(AxBxCxDxE) W

A Capacity compensation coefficient of indoor air wet-bulb temperature condition.

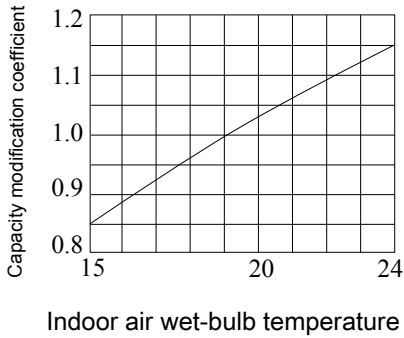

B Capacity compensation coefficient of outdoor air dry-bulb temperature condition.

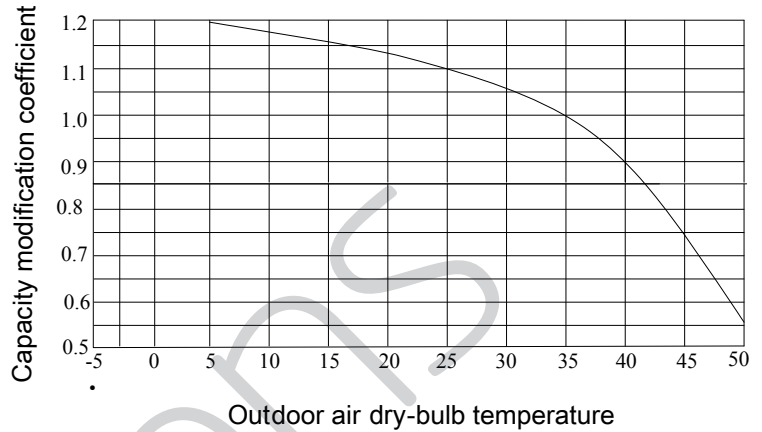

C Capacity modification coefficient under airflow variation rate of indoor unit group (only for duct unit)

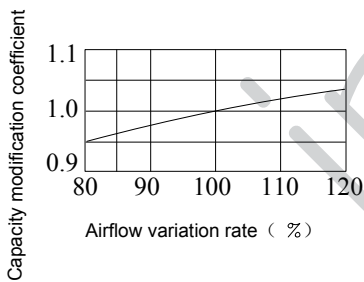

D Capacity compensation suitable for total capability of indoor unit group (cooling)

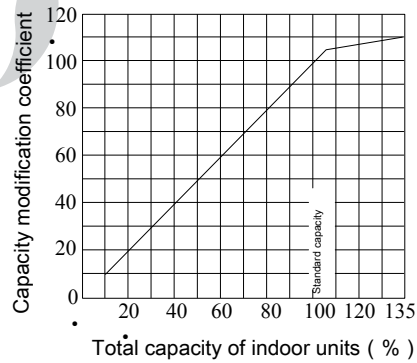

E: Capacity compensation value at different piping length and drop

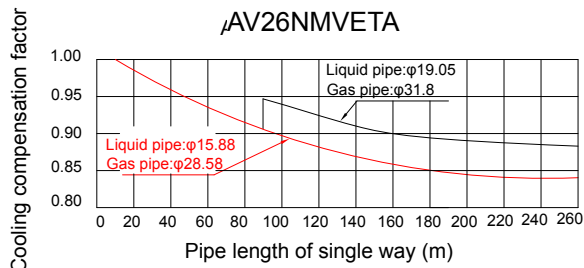
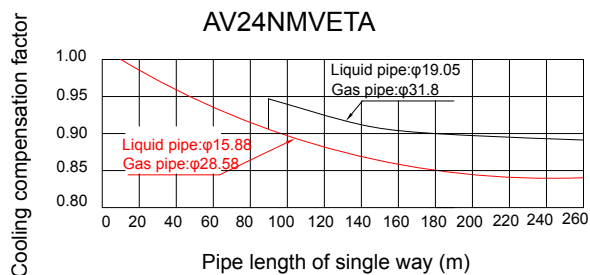
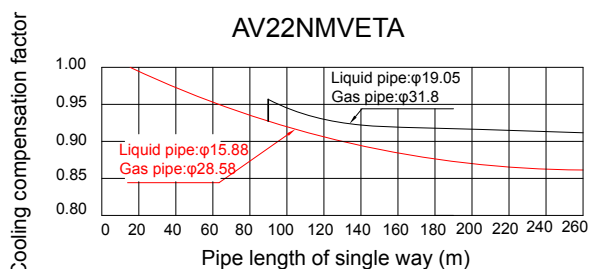
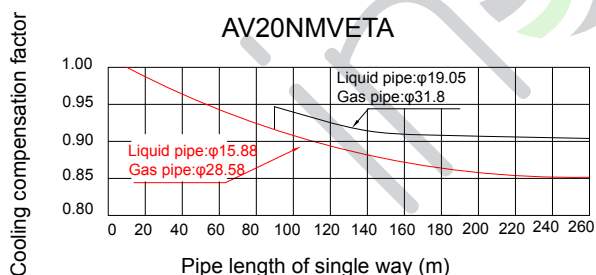
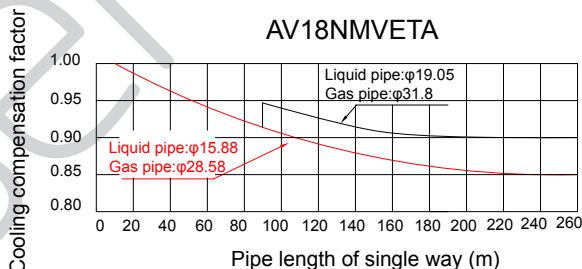
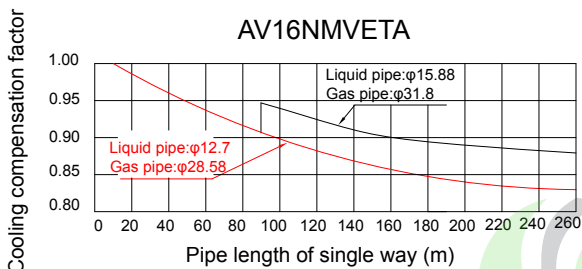
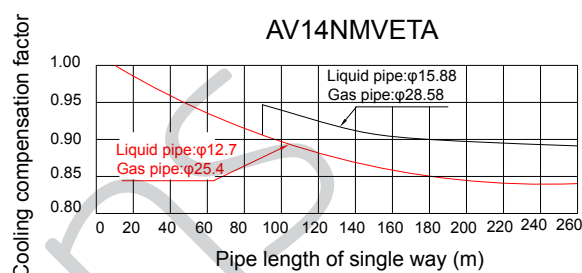
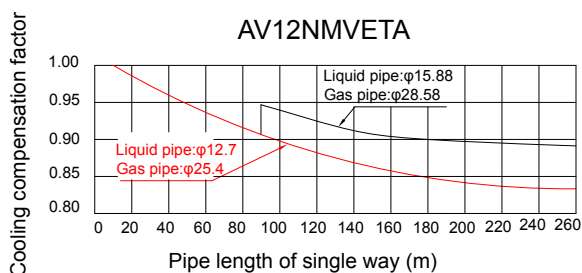
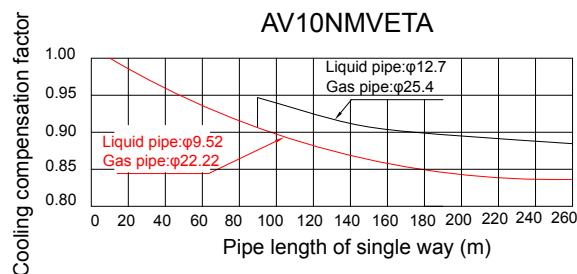
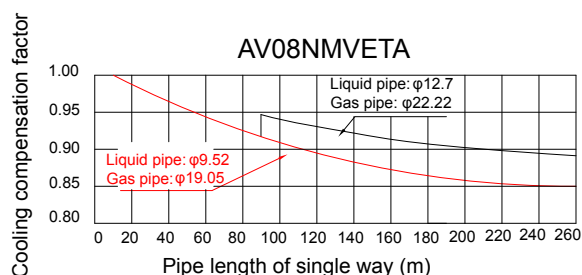

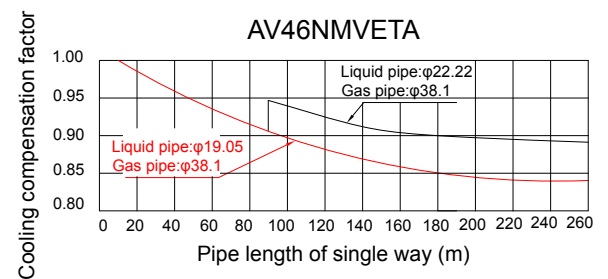
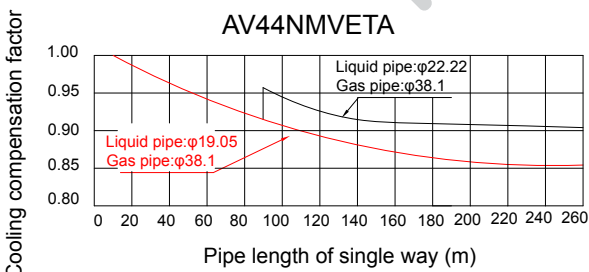
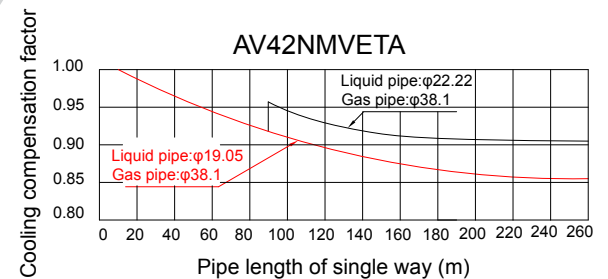
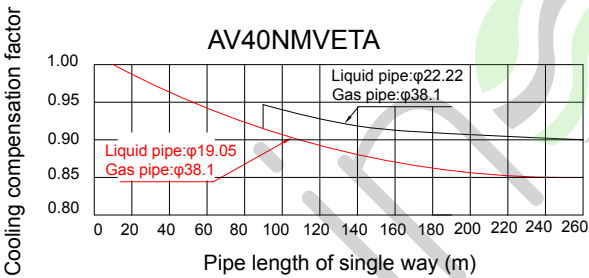
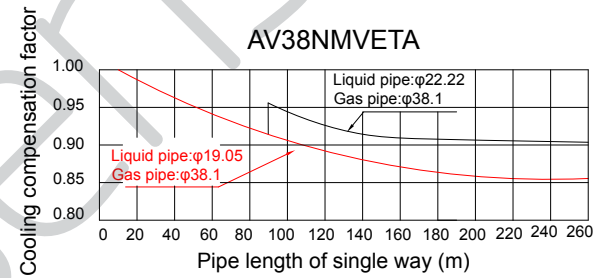
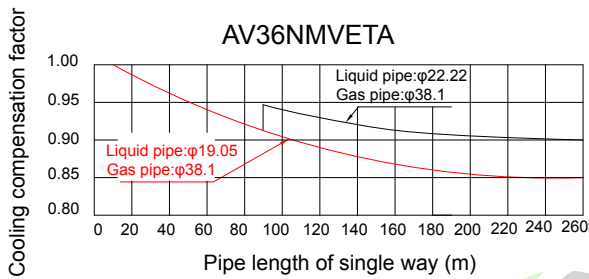
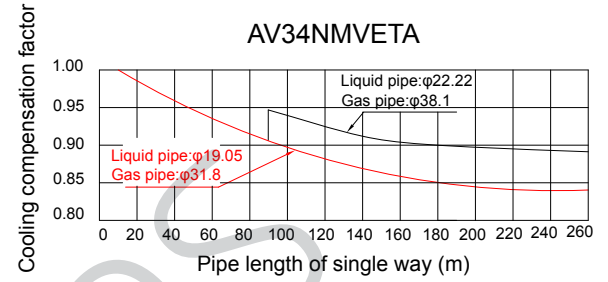
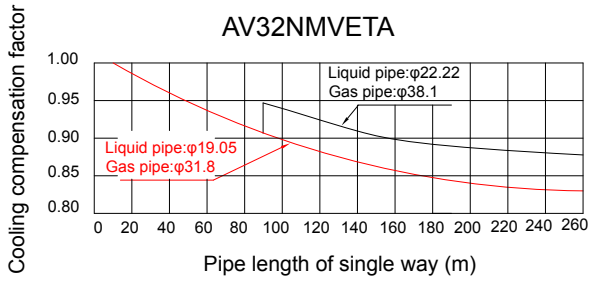
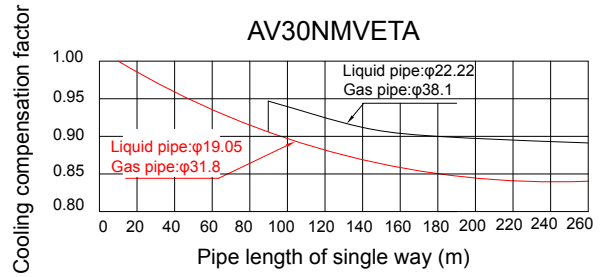
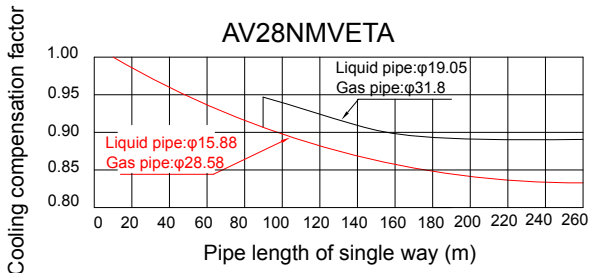

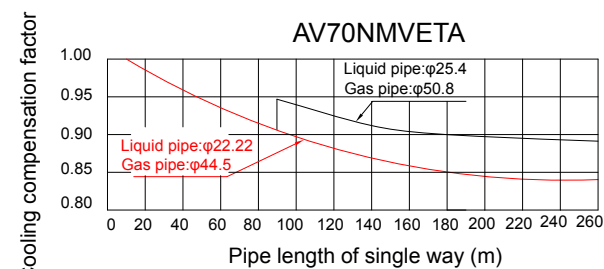
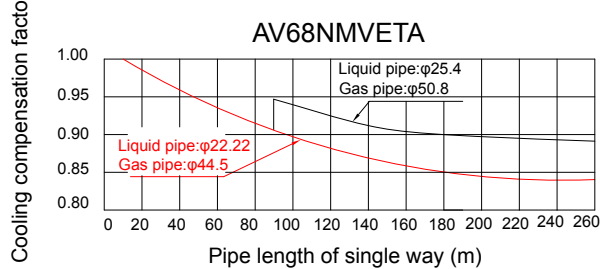
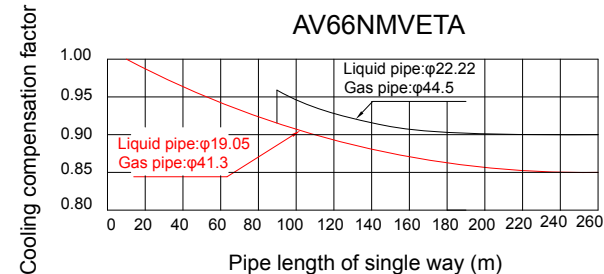
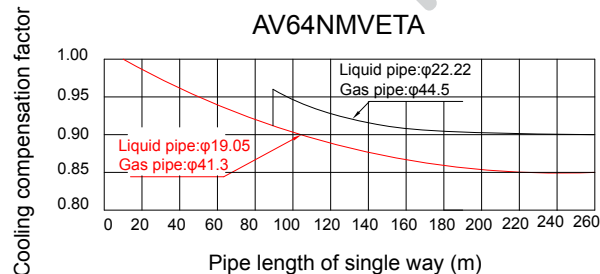
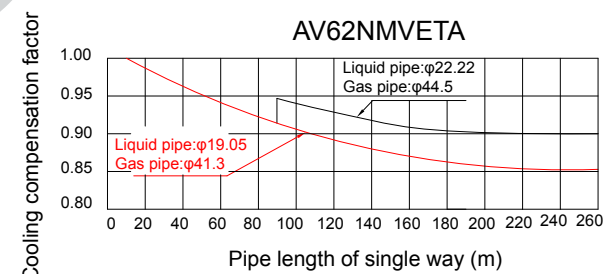
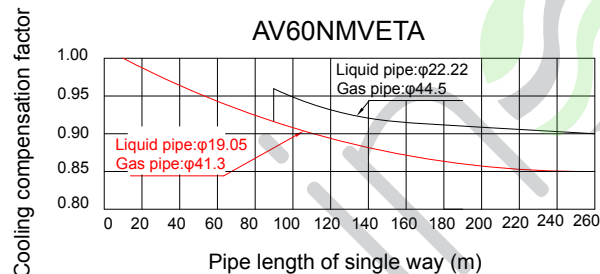
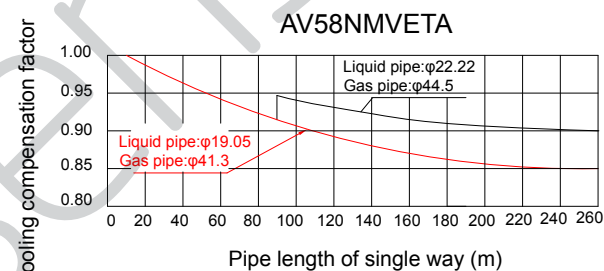
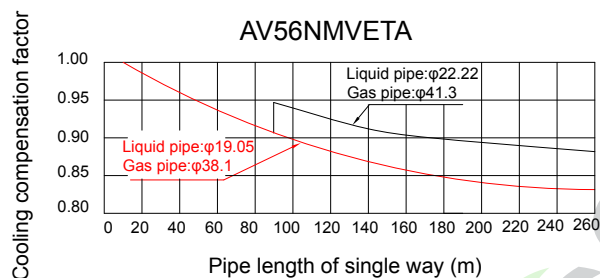
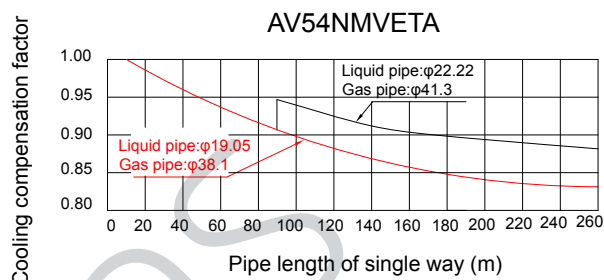
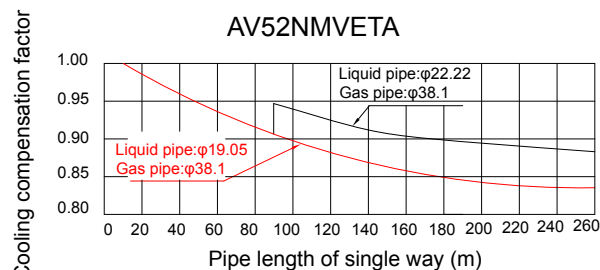
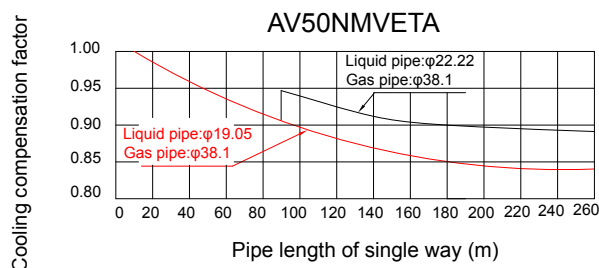
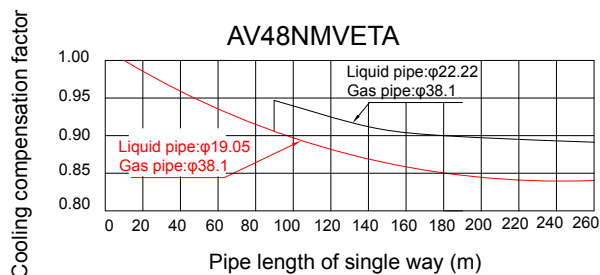

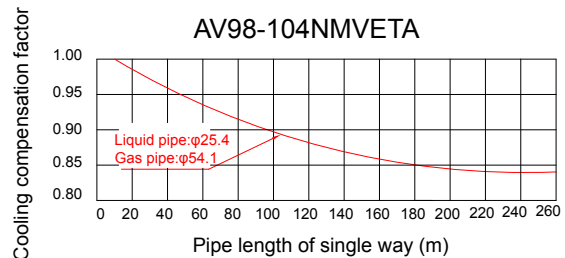
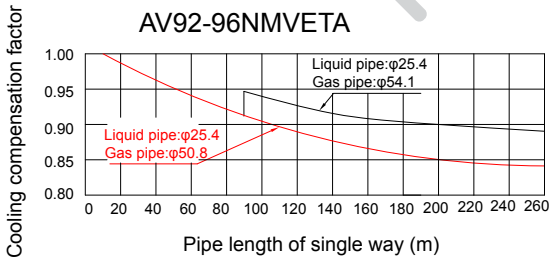
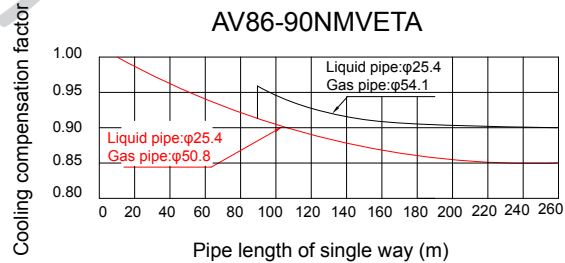
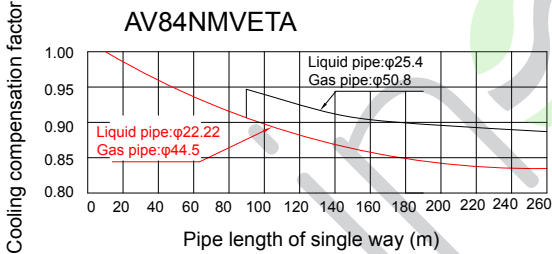
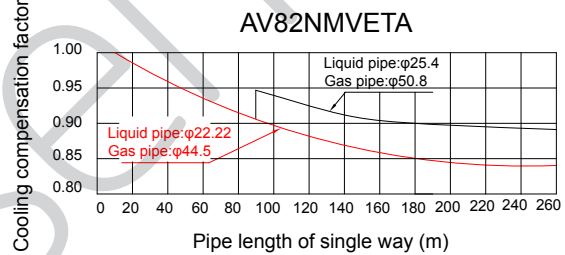
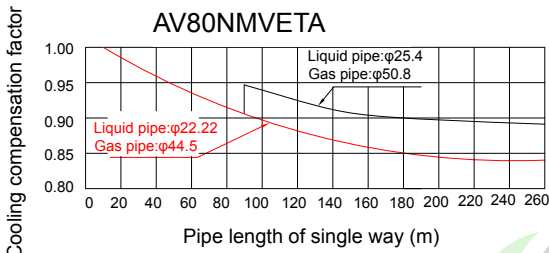
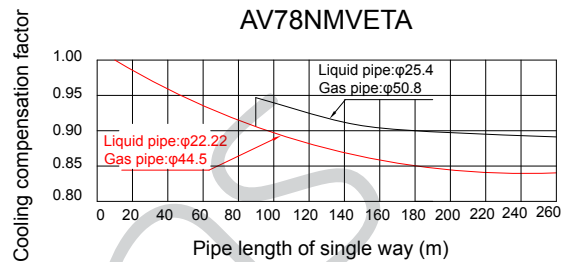
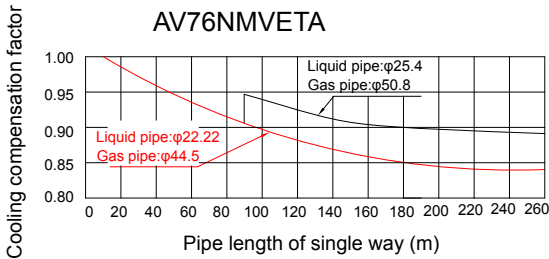
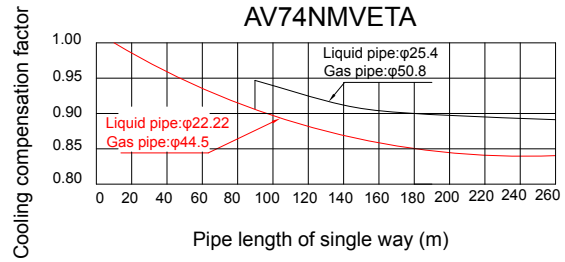
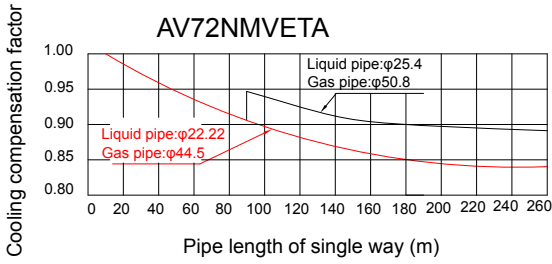

Note:

1. The refrigerant pipe should be thickened when the single way length is over 90m.
2. When in cooling mode, outdoor is lower than indoor; or when in heating mode, outdoor is higher than indoor, the compensation factor should be decreased the below value from the above figure.

Vertical height drop between indoor and outdoor	5m	10m	15m	20m	25m	30m	35m	40m	45m	50m	60m	70m	80m	90m	100m	110m
Adjustment factor	0.003	0.006	0.009	0.012	0.015	0.018	0.021	0.024	0.027	0.03	0.033	0.036	0.039	0.042	0.045	0.05

(2) Calculation method of heating capacity---Heating capacity to be known=Heating capacity x(AxBxCxDxExF) W

A. Capacity modification value under indoor air dry-bulb temperature condition.

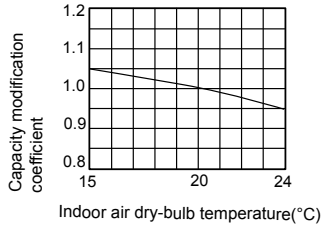

B. Capacity modification value under outdoor air wet-bulb temperature condition.

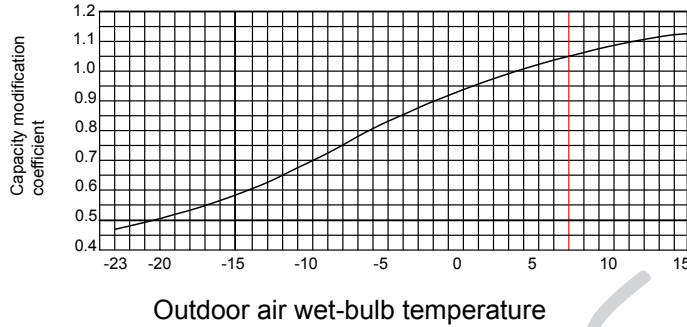

C. Capacity modification value under airflow variation rate of indoor unit group.

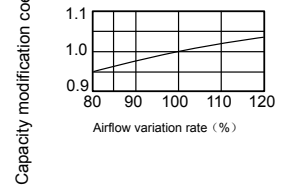

D. Capacity compensation suitable for total capability of indoor unit group(heating)

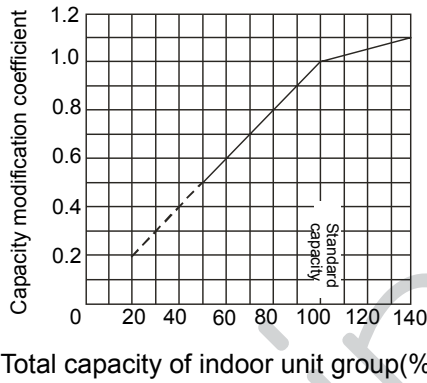

E. Capacity compensation coefficient for defrost capability of outdoor heat exchanger.

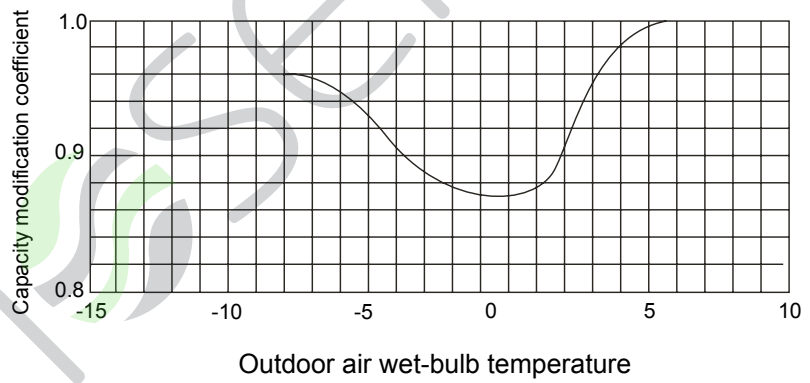

F. Heating compensation factor at different pipe length

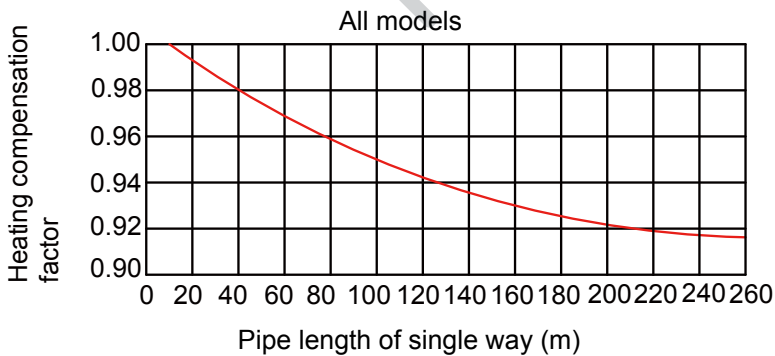

(3) Calculation method of refrigeration capacity-Only one indoor unit running
 Outdoor modified capacity with a single indoor running=Outdoor modified capacity* $\frac{\text{stand by indoor normal capacity}}{\text{indoor total normal capacity}}$

Outdoor modified capacity heating or outdoor capacity after modify item 1 and 2)

11. Selection procedure

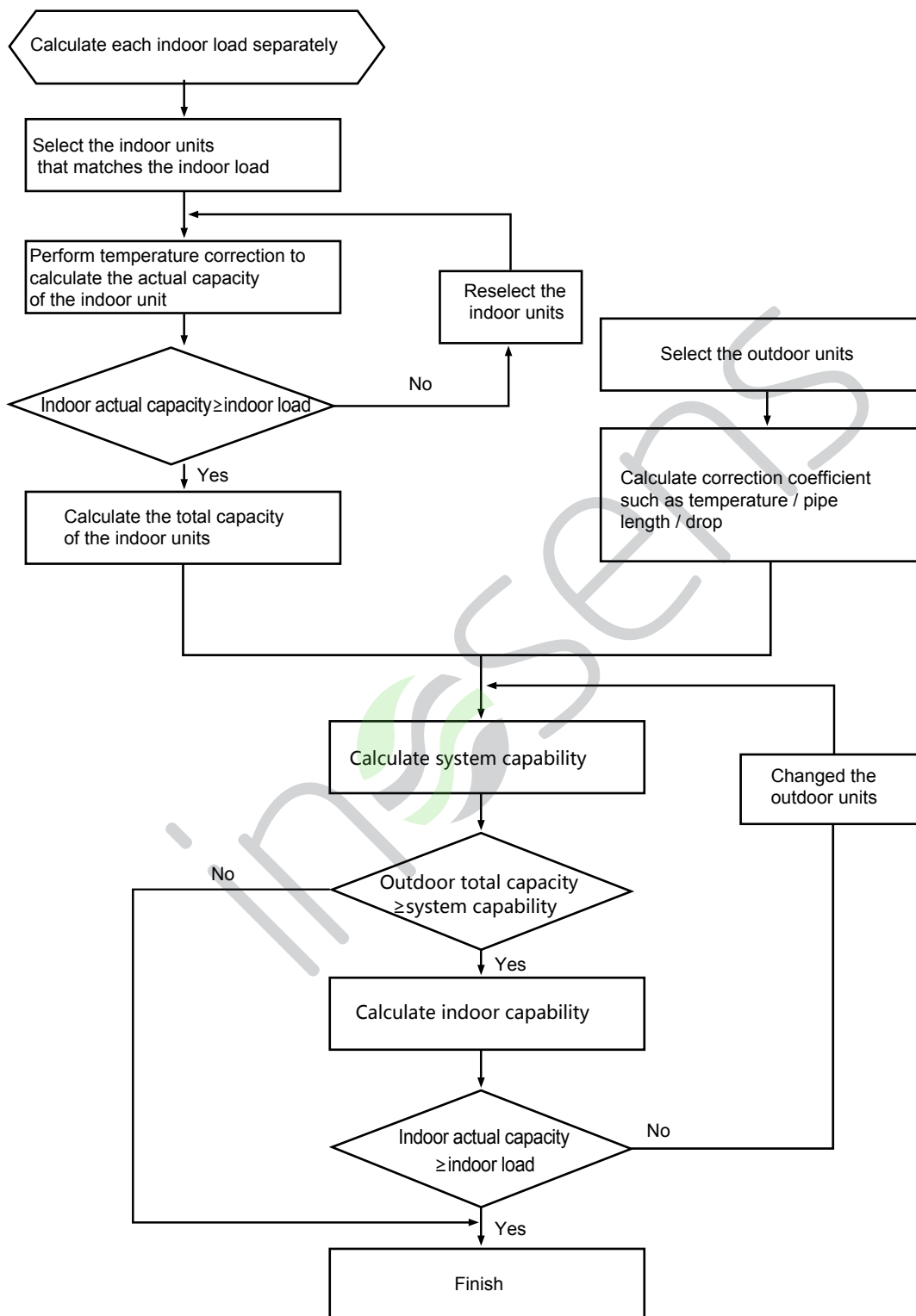

12. Operation range

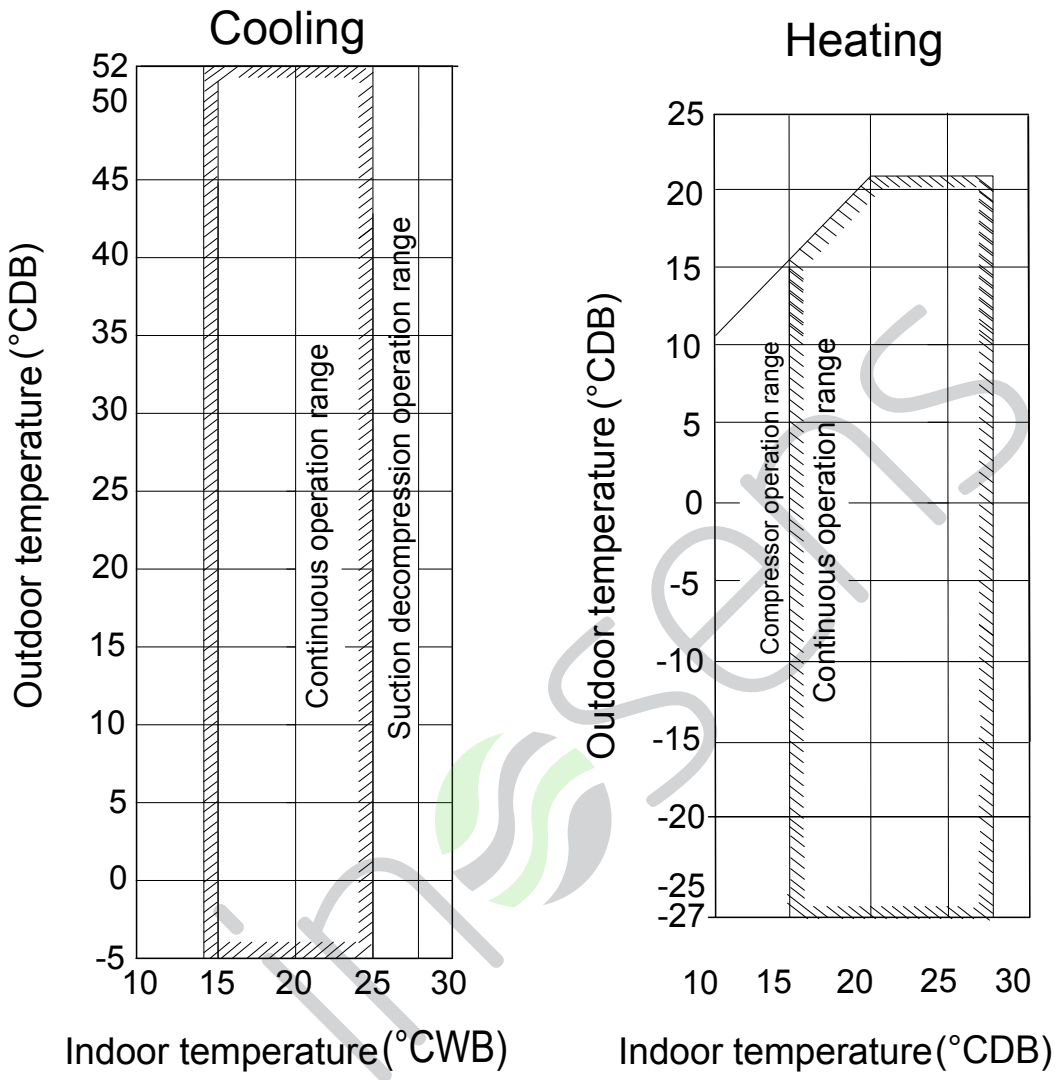

13. Noise level

1) Testing illustrate

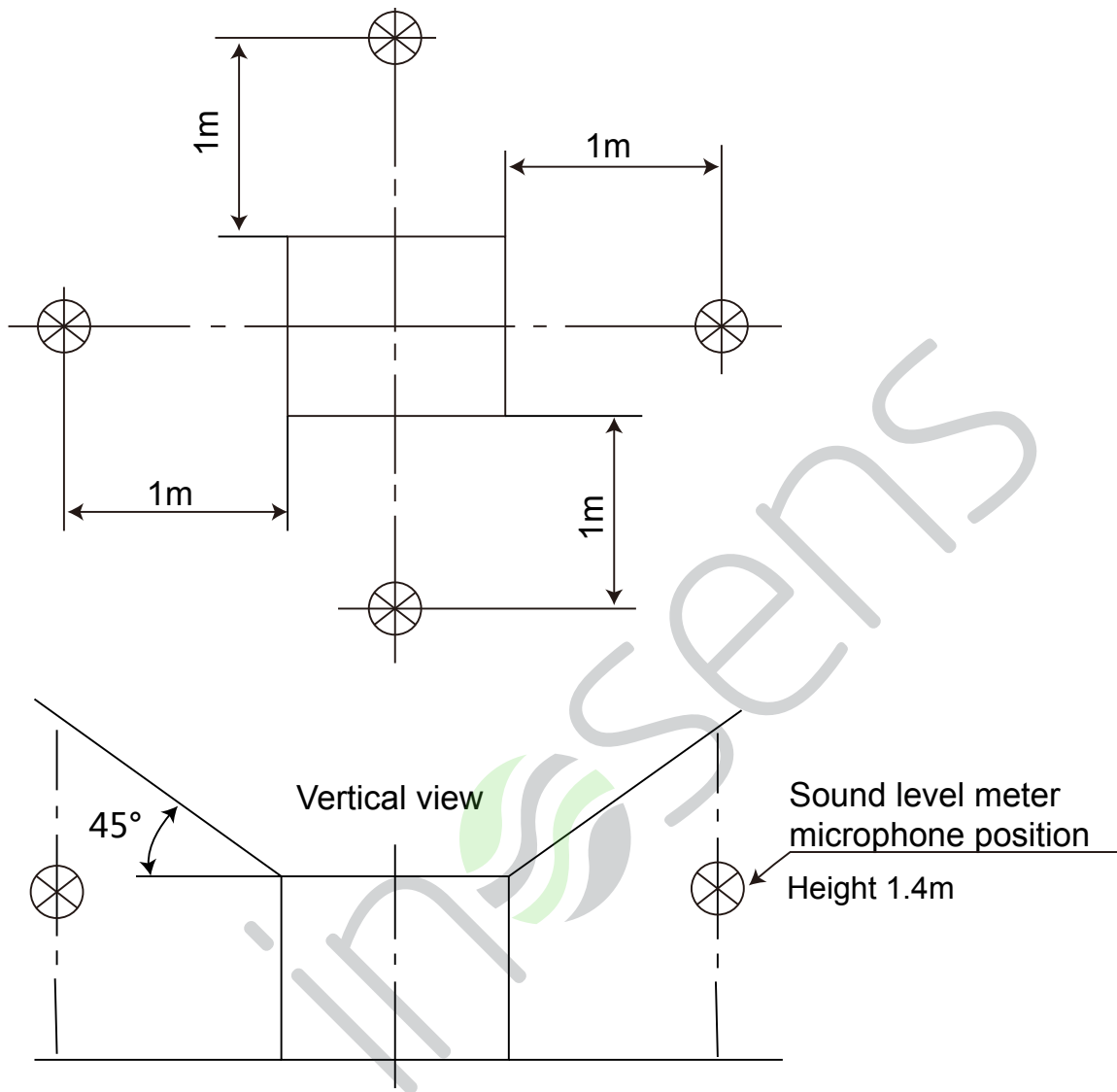

2) Octave band level

AV08/10NMVETA

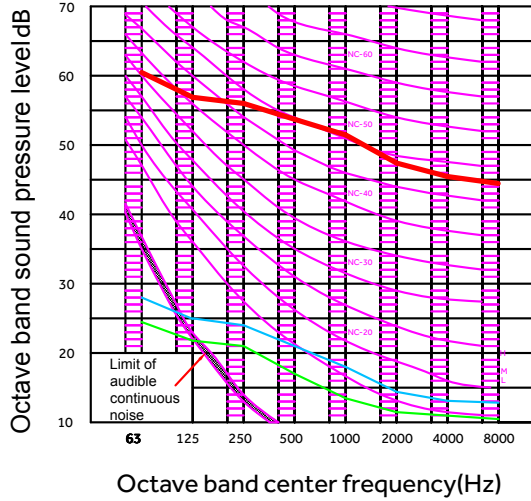

AV12/14NMVETA

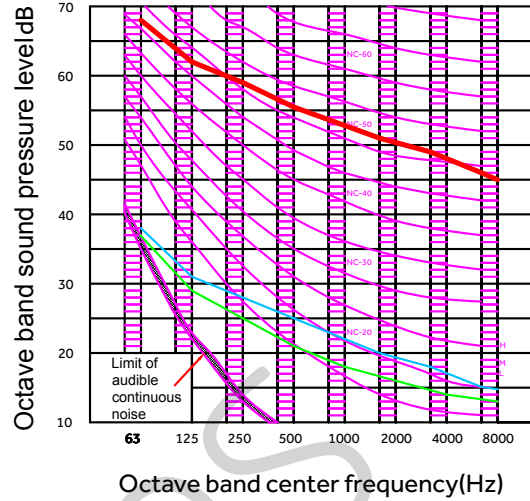

AV16NMVETA

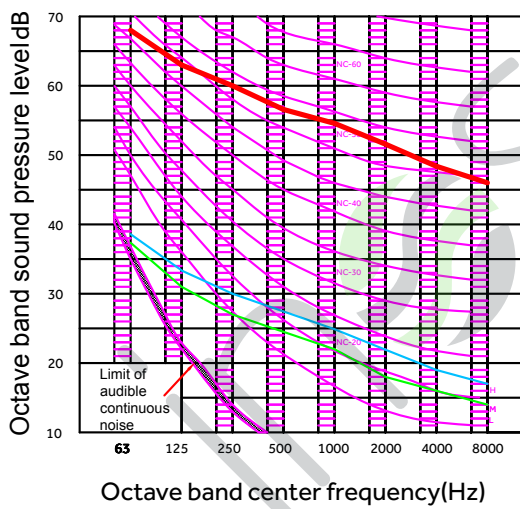

AV18/20/22NMVETA

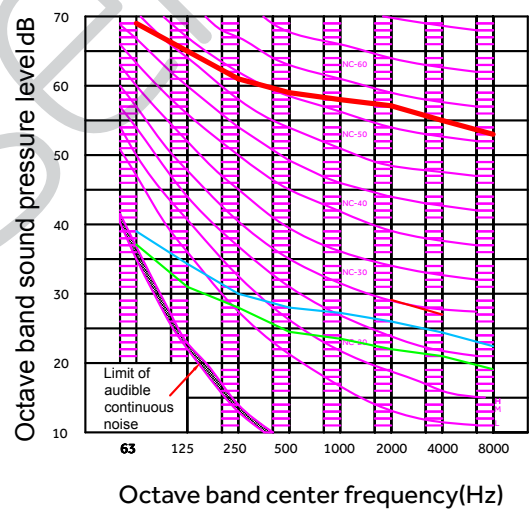

AV24/26NMVETA

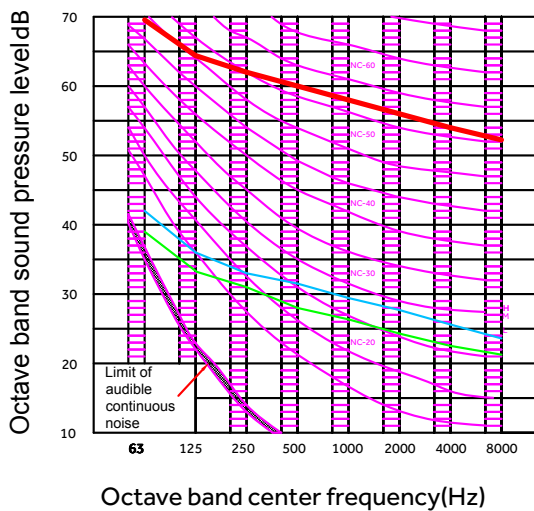

14. Installation

14.1 Safety

- If the air conditioner is transferred to the others, this manual should be transferred together.
- Before installation, please read "Safety precaution" carefully to confirm the correct installation.
- The mentioned precaution includes "⚠WARNING" and "⚠CAUTION". The precaution caused death or heavy injury for faulty installation will be listed in "⚠WARNING". Even the cautions listed in "⚠CAUTION" also may cause serious accident. So both of them are related to the safety, and should be executed severely.
- After installation, perform a trial and confirm everything normal, then introduce the operation manual to the user. Besides, put the manual to the user and ask them to preserve it carefully.

⚠WARNING

- The installation or the maintenance should be performed by the authorized agency. Or the non-specialized operation will cause water leakage, electric shock or fire etc. accidents.
- The installation should be executed as per the manual, or the faulty installation will cause water leakage, electric shock or fire etc. accidents.
- Please install the unit at the space which can bear the weight. Or the unit will drop down to cause the human injury.
- The installation should defend against the typhoon, and the earthquake etc. Abnormal installation will cause the unit fall down.
- Use the correct cable and make reliable earthing. Fix the terminal firmly and the loose connection will cause heating or fire etc. accident.
- The wiring should be in shape and can not be raised. Be earthed firmly and can not be clipped by the electric box cover or the other plate. The incorrect installation will cause heating or fire.
- When setting or transferring the unit, there should not be other air into the refrigerant system except for R410A. The gas mixture will cause the abnormal high pressure which will cause break or human injury etc. accidents.
- When installation, please use the accessories with the unit or the special parts, or it will cause water leakage, electric shock, fire, refrigerant leakage etc. accidents.
- Don't lead the water drainage pipe into the drainage groove with the poisonous gas, such as sulphur. Or the poisonous gas will enter indoor.
- In installation or after installation, please confirm if there is refrigerant leakage, please take measures for ventilation. The refrigerant will cause poisonous gas as meeting fire.
- Don't install the unit at the place where there may be flammable gas leakage. In case the gas leaks and gather around the unit, it will cause fire.
- The drainage pipe should be installed as per the manual to confirm the fluent drainage. Also take measures for heat insulation against dew drop. Incorrect water pipe installation will cause water leakage even and make the things wet.
- For the liquid pipe and the gas pipe, take measures for heat insulation too. If there is no heat insulation, the dew drop will wet the things.

⚠CAUTION

- Execute earthing for the unit. But the earthing wire can not be connected to the gas pipe, water pipe, lightning rod or the telephone earthing wire. Improper earthing will cause electric shock.
- Don't install the unit at the place where leaks the flammable gas. Or it will cause fire.
- Execute the water drainage pipe according to the manual, improper installation will cause water leakage to wet the family things.
- The outdoor fan can not face to the flower or the other vegetable, or the blowing gas will make the flower dried up.
- Please ensure the maintenance room, if not, it will cause the maintenance person damaged.
- When installing the unit on the roof or the other high place, to prevent the person falling down, please set the fixed ladder and the railing at the passage.
- Use the two-end spanner, and fasten the nut at proper torque. Don't fasten the nut excessively against the flared section broken. Or it will cause refrigerant leakage and lack of oxygen.
- Take measures for heat insulation to the refrigerant pipe, or there will be water leakage or dew drop to wet the family things.
- After finishing the refrigerant pipe, make leakage test by charging the nitrogen. In case the refrigerant leaks in a small room and exceeds the limited concentration, it will cause lack of oxygen.
- Don't use the other refrigerant except for R410A. The R410A pressure is 1.6 times higher than R22 pressure. The refrigerant R410A tank is marked with pink sign.
- Against charging different refrigerant, we changed the stop valve diameter of the R410A unit. To enhance the compression consistence, we also changed the flared pipe dimension. Prepare the R410A specially tools according to the below table.

	R-410A specified tools	Remarks
1	Gauge manifold	Range: HP > 4.5MPa, LP > 2MPa
2	Charge hose	Pressure: HP: 5.3MPa, LP: 3.5MPa
3	Electronic balance for charging R410A	Can not use the measurable charging tank
4	Torque spanner	
5	Flare tool	
6	Copper pipe gauge for adjusting projecting margin	
7	Vacuum pump adapter	Must be with reverse stop valve
8	Leakage detector	Can not use freon leakage detector, but the He detector

- When charging refrigerant, the refrigerant must be taken out as liquid state from the tank.
- When installing indoor unit, outdoor, power cable and connecting wire, leave them at least 1m away from the TV set or the radio against interference for the image or the noise.
- In the room with fluorescent lamp (reverse phase or rapid start type), the remote signal may be not reach the pre-set distance. The farther that indoor is away from fluorescent lamp, the better.
- The tightening torque of the stop valve refer to the following table

Operating valve size (mm)	Fastening torque (N.m)	Fastening angle (°)	Recommended tool length (mm)
Ø6.35	14~18	45~60	150
Ø9.52	34~42	30~45	200
Ø12.7	49~61	30~45	250
Ø15.88	68~82	15~20	300
Ø19.05	84~98	15~20	300

- When loaded into a refrigerant, be sure to take it out of the tank.
- Installation of indoor, outdoor, power lines and connections must be at least 1m away from the TV or radio to avoid image interference or noise.
- In a room equipped with fluorescent lamps (RP or fast start), the remote control signal transmission distance may not reach a predetermined value. The farther away the indoor machine is, the better it is.

14.2 Installation instruction

In installation, please check specially the below items:

- If the connected units quantity and the total capacity is in the allowable range?
- If the refrigerant pipe length is in the limited range?
- If the pipe size is proper? And if the pipe is installed horizontally?
- If the branch pipe is installed horizontally or vertically?
- If the additional refrigerant is counted correctly and weighed by the standard balance?
- If there is refrigerant leakage?
- If all the indoor power supplies can be on/off simultaneously?
- If the power voltage is in compliance with the data marked on the rating label?
- If the address of indoors and outdoors has been set?

Before installation

- 1) Before installation, check if the model, power supply, pipe, wires and parts purchased respectively are correct.
- 2) Check if the indoors and outdoors can be combined as the following.



HP	Capacity (W)	Combination Type	Indoor			Gather pipe	Combined capacity range
			Allow the most connected indoor units	The most recommended indoor unit number	Total indoor capacity(100W)		
8	25200	single	15	8	126~328	-	50%~130%
10	28000	single	17	10	140~364	-	
12	33500	single	20	11	168~436	-	
14	40000	single	24	13	200~520	-	
16	45000	single	27	15	225~585	-	
18	50400	single	30	17	252~655	-	
20	56000	single	33	18	280~728	-	
22	61500	single	36	20	308~800	-	
24	68000	single	40	22	340~884	-	
26	73500	single	43	24	368~956	-	
28	80000	combination(14+14)	47	26	400~1040	HZG-20B	
30	85000	combination(14+16)	50	28	425~1105		
32	90000	combination(16+16)	53	30	450~1170		
34	95400	combination(16+18)	56	31	477~1240		
36	100800	combination(18+18)	59	33	504~1310		
38	106400	combination(18+20)	63	35	532~1383		
40	112000	combination(20+20)	66	38	560~1456		
42	117500	combination(20+22)	69	42	588~1528		
44	123000	combination(22+22)	72	44	620~1612		
46	129500	combination(22+24)	76	46	648~1684		
48	136000	combination(24+24)	80	49	680~1768		
50	141500	combination(24+26)	83	51	707~1840		
52	147000	combination(26+26)	86	52	735~1911		
54	151200	combination(18+18+18)	89	54	756~1966		HZG-30B
56	156800	combination(18+18+20)	92	59	784~2038		

HP	Capacity (W)	Combination type	Indoor			Gather pipe	Combined capacity range
			Allow the most connected indoor units	The most recommended indoor unit number	Total indoor capacity (HP)		
58	162400	combination(18+20+20)	96	61	812~2111	HZG-30B	50%~130%
60	168000	combination(20+20+20)	99	63	840~2184		
62	173500	combination(20+20+22)	100	64	868~2256		
64	179000	combination(20+22+22)	100	64	895~2327		
66	184500	combination(22+22+22)	100	64	922~2398		
68	191000	combination(22+22+24)	100	70	955~2483		
70	197500	combination(22+24+24)	100	70	988~2568		
72	204000	combination(24+24+24)	100	70	1020~2652		
74	209500	combination(24+24+26)	100	70	1048~2723		
76	215000	combination(24+26+26)	100	70	1075~2795		
78	220500	combination(26+26+26)	100	76	1103~2867		
80	224000	combination(20+20+20+20)	100	76	1120~2912		
82	229500	combination(20+20+20+22)	100	76	1148~2984		
84	235000	combination(20+20+22+22)	100	76	1175~3055		
86	240500	combination(20+22+22+22)	100	76	1203~3127		
88	246000	combination(22+22+22+22)	100	76	1230~3198		
90	252500	combination(22+22+22+24)	100	85	1263~3283		
92	259000	combination(22+22+24+24)	100	85	1295~3367		
94	265500	combination(22+24+24+24)	100	85	1328~3452		
96	272000	combination(24+24+24+24)	100	85	1360~3536		
98	277500	combination(24+24+24+26)	100	85	1388~3608		
100	283000	combination(24+24+26+26)	100	85	1415~3679		
102	288500	combination(24+26+26+26)	100	89	1443~3751		
104	294000	combination(26+26+26+26)	100	89	1470~3822		

Note:

- a. If all the indoor units operate at the same time in one system, the total indoor units capacity should be less than or equal to the total outdoor units capacity. Otherwise,overloading operations may occur in bad operating condition or some special conditions. If all the indoor units don't operate at the same time in one system,the total indoor units capacity should be no more than 130% of the total outdoor units capacity.
- c. If the system operates in high heat load or cold area (Ambient Temperature below -10°C), the total indoor units capacity should be less than the total outdoor units capacity.
- d. To choose combinations' wires and air switches according to the Max. operating current of the combinations.

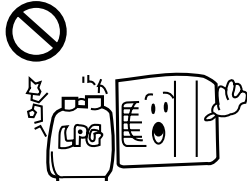
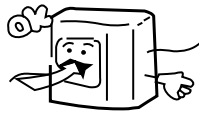
Installation place selection

<p>Air-conditioner can't be installed in the place with inflammable gas. Or it will cause fire hazard.</p> 	<p>The unit should be installed at the place with good ventilation. No obstacle at the air inlet/outlet. And no strong wind blows the unit.</p>  <p>The installation space refers to the latter info.</p>	<p>The unit should be installed at the strong enough place. Or it will cause vibration and noise.</p> 
--	--	---

The unit should be installed at the place where the cold/hot air or noise will not interfere the neighbours.



- The place where the water can flow fluently.
- The place where no other heat source will affect the unit.
- Pay attention to the snow against clogging the outdoor.
- In installation, install the anti-vibration rubber between the unit and the bracket.

- The unit is better not be installed at the below places, or it will cause damage.
- The place where there is corrosive gas (spa area etc.).
- The place blowing salty air (seaside etc.).
- Exists the strong coal smoke.
- The place with high humidity.
- The place where there is device emitting Hertzian waves.
- The place where voltage changes greatly.

Transportation

- In transportation, please don't dismantle the packaging, and move the unit to the installation location as closely as possible.
- Don't hang the unit only at two points. When hanging the unit, don't sit on the unit. The unit should be upright. When removing the unit with the forklift, put the fork into the special hole at bottom of the unit. When being hanged, the rope should be 4 pieces of steel cable with over 8mm diameter. Put the cushion at the contact section between steel cable and the unit against the distortion or damage.

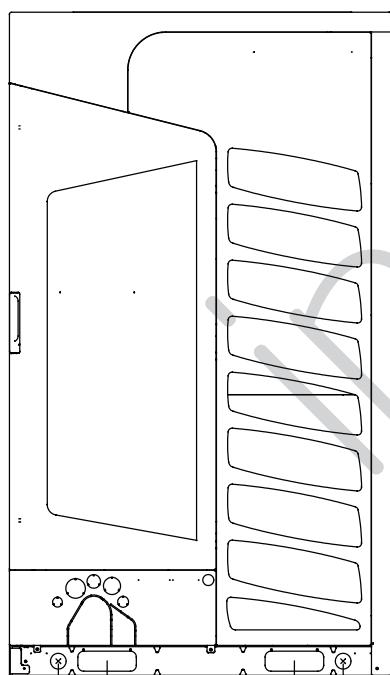

Forklift hole distance
480mm

Hoisting hole diameter $\varnothing 40\text{mm}$, distance 730mm

AV08~16NMVETA

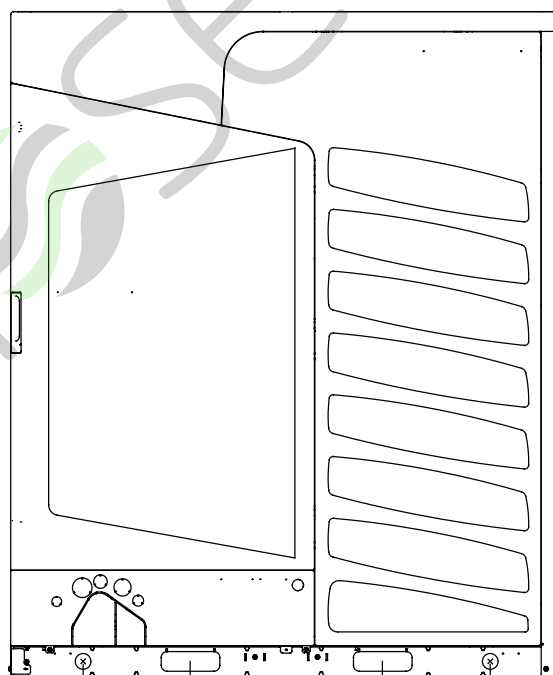

Forklift hole distance
480mm

Hoisting hole diameter $\varnothing 40\text{mm}$, distance 1042mm

AV18~26NMVETA

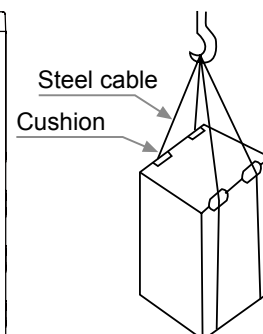

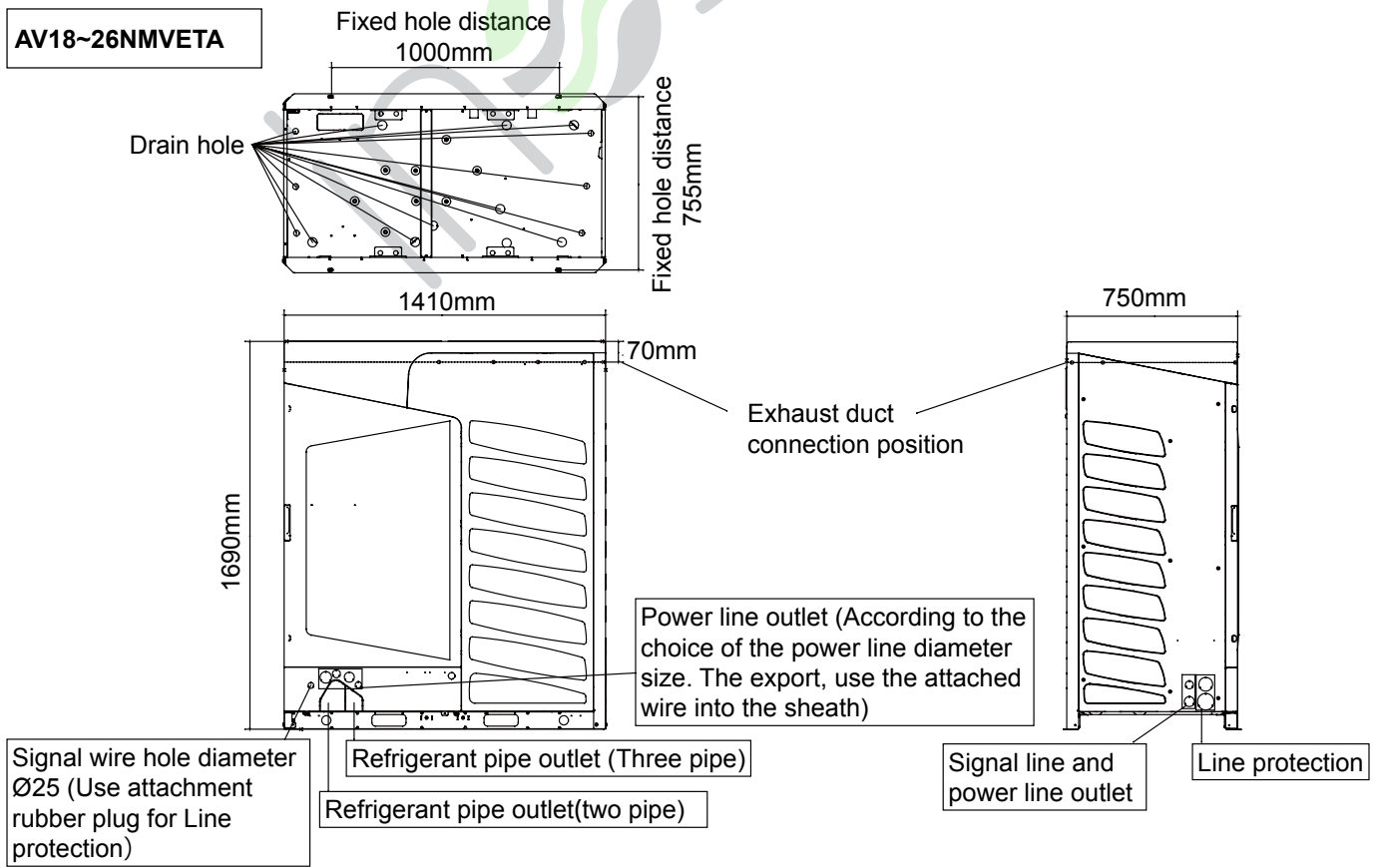
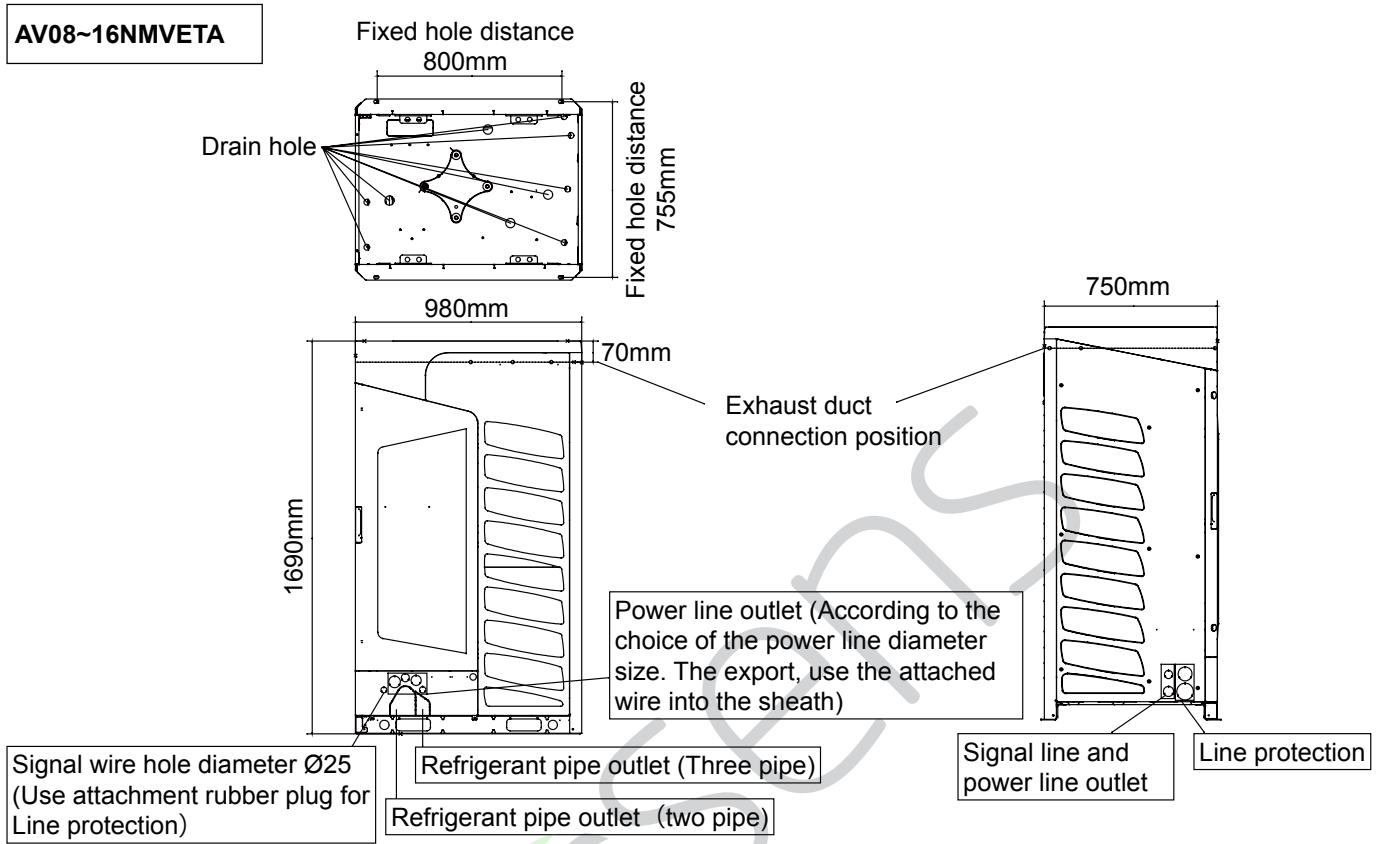

Outline and installation dimensions



Outdoor unit installation

Standard accessories

Please check the attachment is complete, please be sure to use.

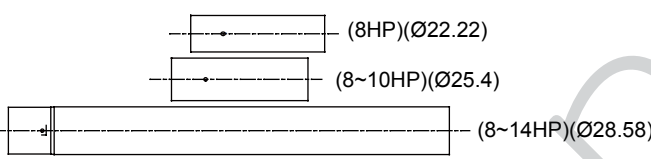
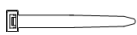
No.	definition	Graphic	Quantity	Remarks	Place position
1	Installation instruction		1		Accessory bag
2	Rubber plug		1	Signal line protection	Accessory bag
3	Sheath		1	Power line protection	Accessory bag
4	Reducing pipe		1	Reducing pipe	Accessory bag
5	Wiring harness		4	Gas liquid pipe insulation binding	Accessory bag

1. Choose a place that can carry the weight of the unit to install and fix, so that the unit will not shake or fall. The unit shall be installed in a flat area (below 1/100).
2. Do not install the unit in the areas where there may be flammable, explosive, corrosive gas leakage.
3. Indoor and outdoor machines should be close to each other as much as possible to reduce the length of the refrigerant pipeline and the number of bends.
4. The installation should be to ensure that units from the sun and rain, dust, typhoon, earthquake proof place. In the area of snow, the machine should be installed in the frame or under the snow cover, so as to avoid the machine snow. See Figure 1.
5. Make sure that there is enough room for maintenance.
6. Measures should be taken to avoid contact with children.
7. The refrigerant pipe by the unit below should be used when the overhead, overhead part height 200mm above. See Figure 2

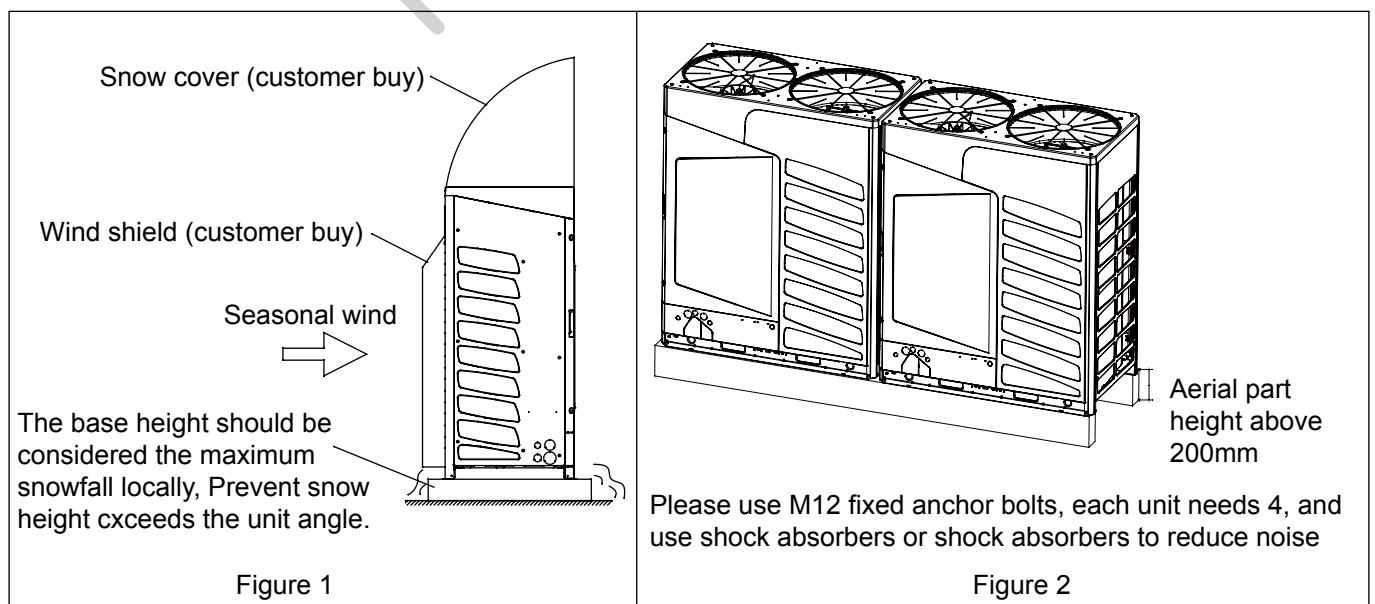

Combination installation dimensions

- There should be no obstacles in 2000mm above the top of outdoor unit;
- Obstacles around outdoor should be less than 900mm to the bottom of unit.
- When multiple modules are installed, the outdoor should be in ranked as the capacity, the larger capacity is closer to the main pipe of gather pipe.

1. Single installation

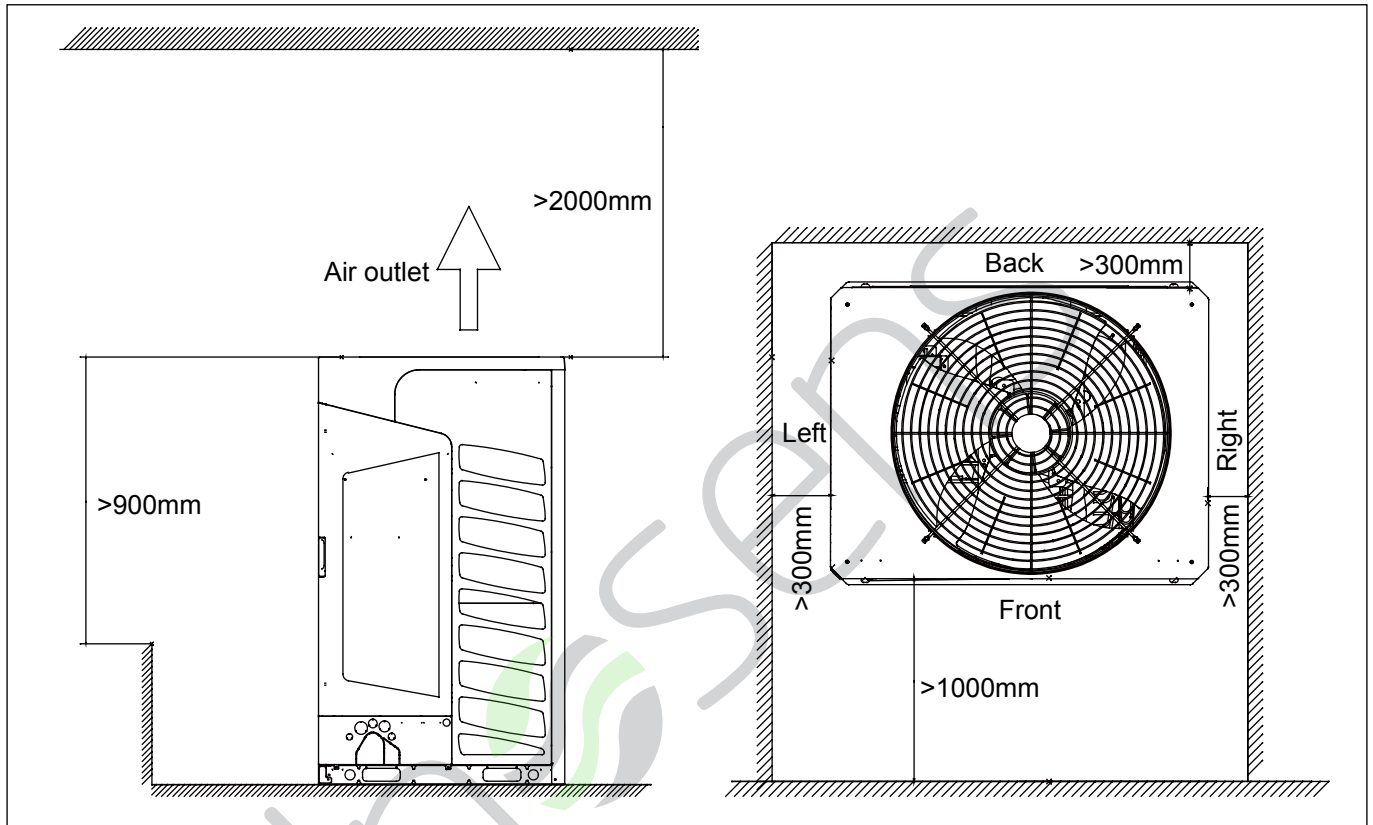

2. Combination installation

Unit can be installed in the same or opposite direction

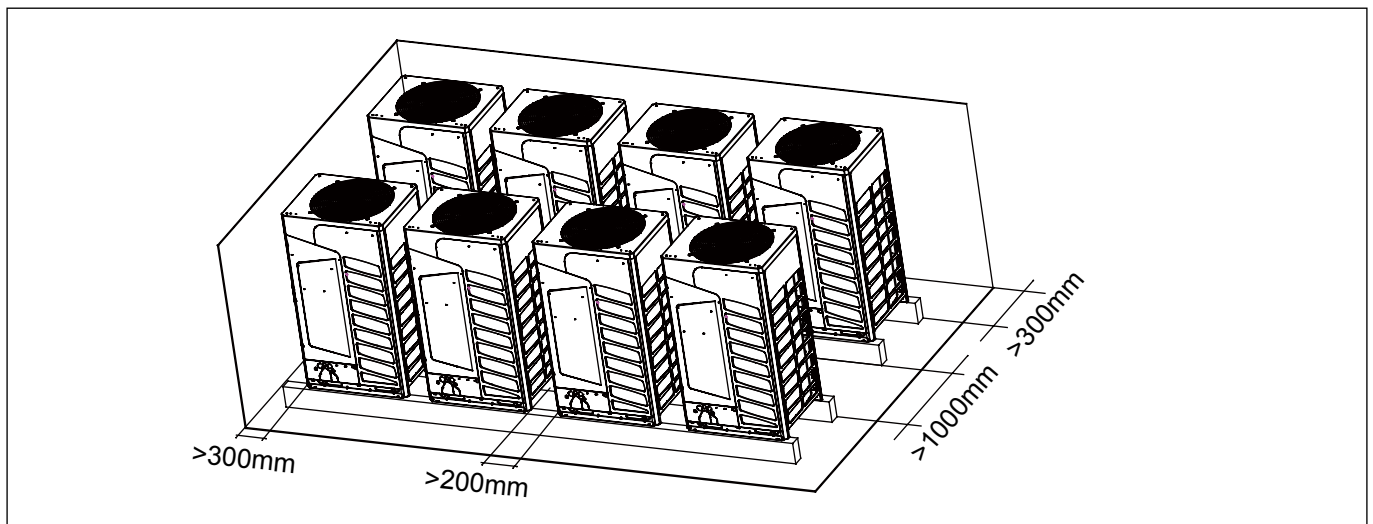

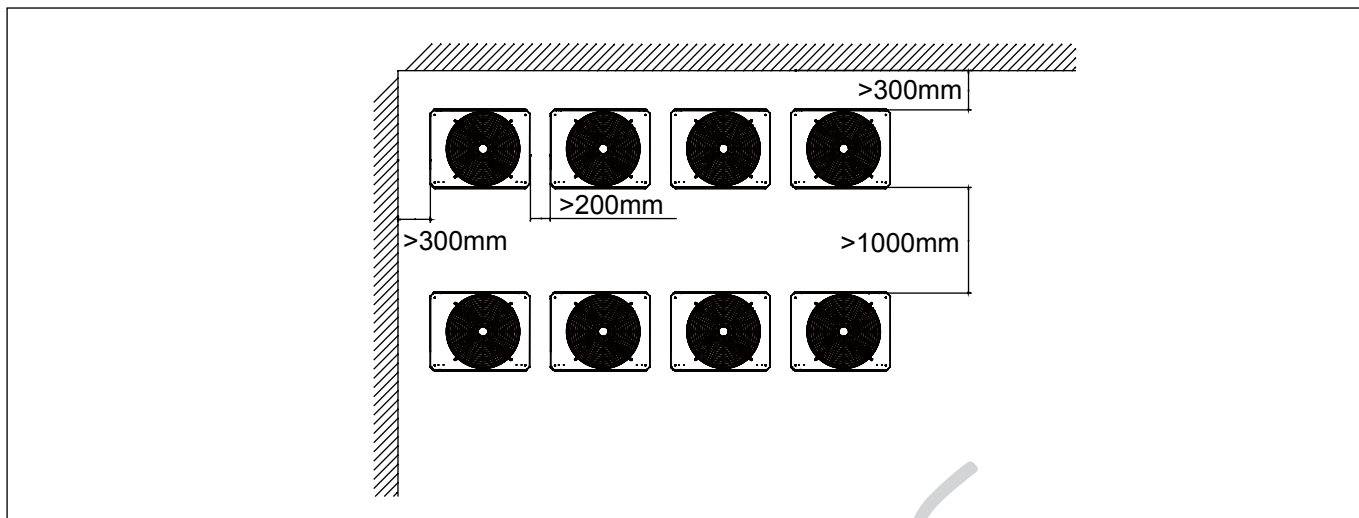

3. Wall higher than the outdoor condenser

Place with air inlet hole

Notes:

- a. Fan speed V_s at air inlet is 1.5m/s or below.
- b. Air outlet height $H_D = H - h$ and below 1m.

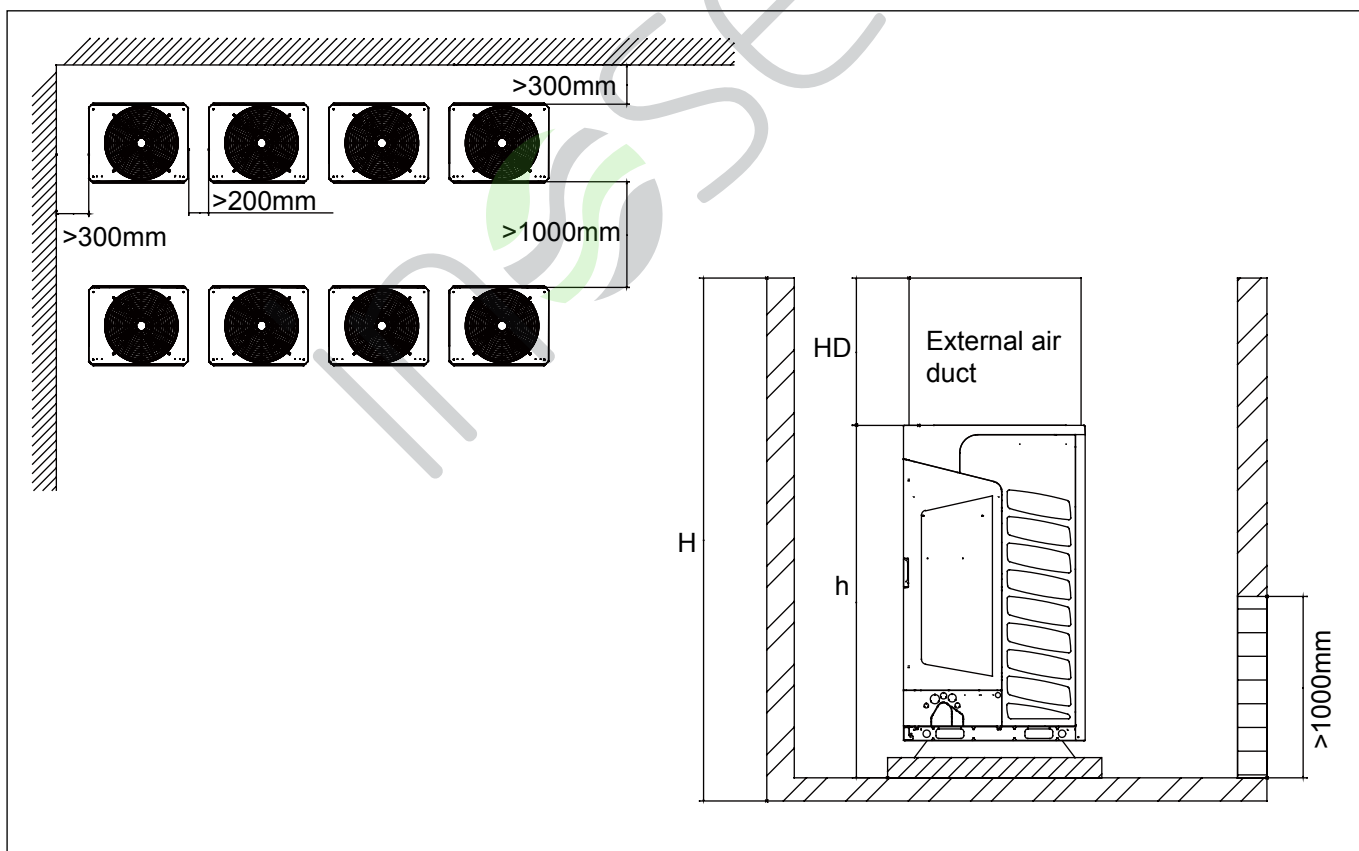

Place without air inlet hole

Notes:

- a. Set a 500~1000mm bracket.
- b. Air outlet height $HD=H-h$ and below 1m.

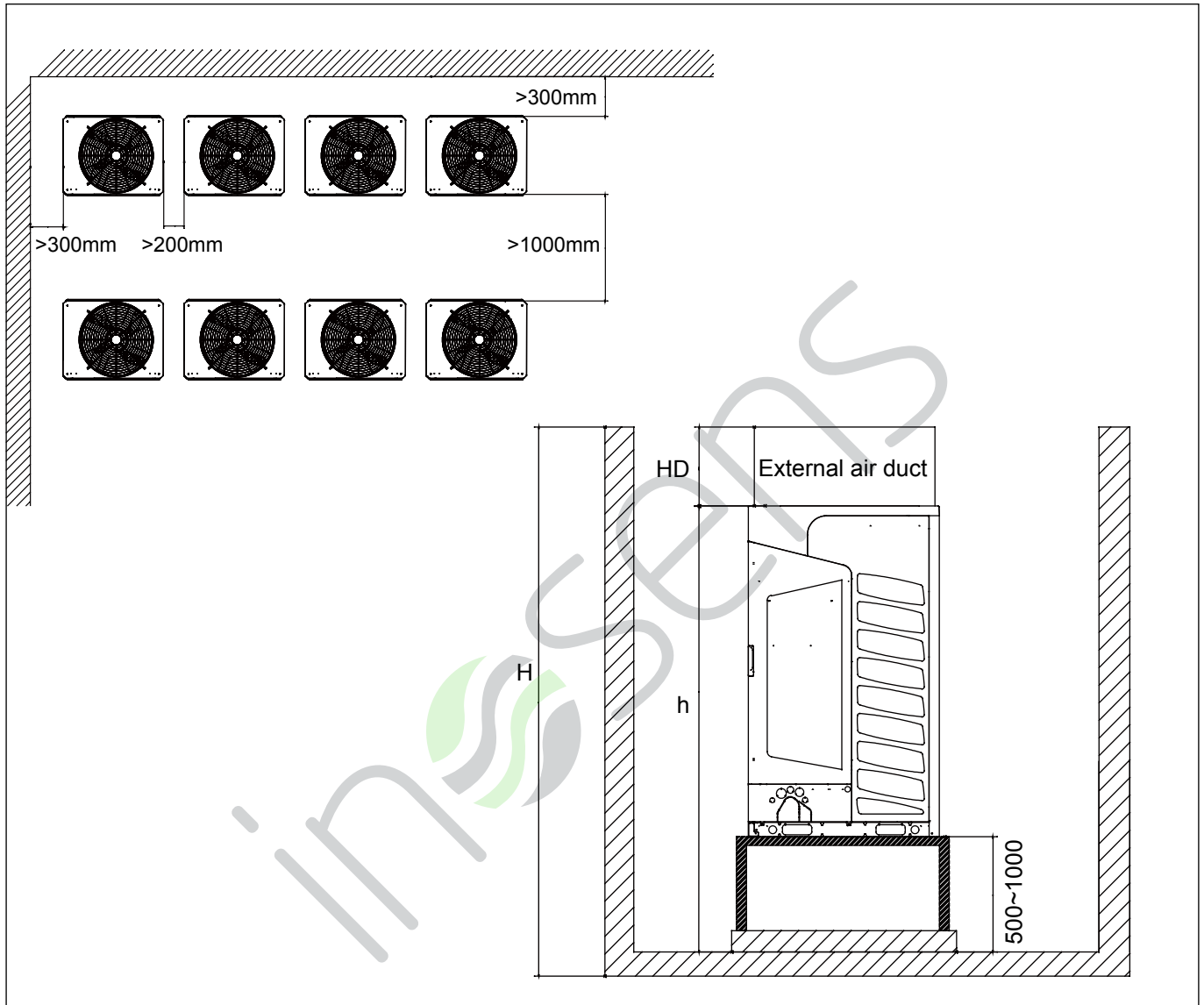

4. The outdoor machine installation should consider the impact of seasonal wind, don't let the wind directly into the unit return air, otherwise it will affect the unit defrosting and related functions.
5. Must be arranged to follow the following principles in the exhaust duct.
 - Install exhaust duct before the machine must be taken out of the wind protection network, otherwise it will affect the output of the unit, and then lead to the decline in performance, and even cause failure.
 - Increase the blinds, the unit will affect the air out of the air, reduce performance, and therefore do not recommend the use of shutters. To use the shutter angle control at 15 degrees below, the distance between the control of 80mm above.
 - The exhaust duct is only allowed to have one elbow, otherwise it will cause bad operation of the machine.
 - Please install the soft connection between the unit and the air duct to prevent vibration and noise.
 - The exhaust air duct of each machine must be installed independently, and the exhaust hood of the machine is prohibited to be assembled in parallel in any form, otherwise it may cause the failure of the unit.

Install snow cover

Snowfall area, please install snow cover, see the right picture, to be unaffected by the snow, it is important to set up a high platform, which is calculated according to the maximum amount of snow in the area. At the same time, the outdoor defrost setting change to be easy to frost setting, detailed see the digital tube setting.

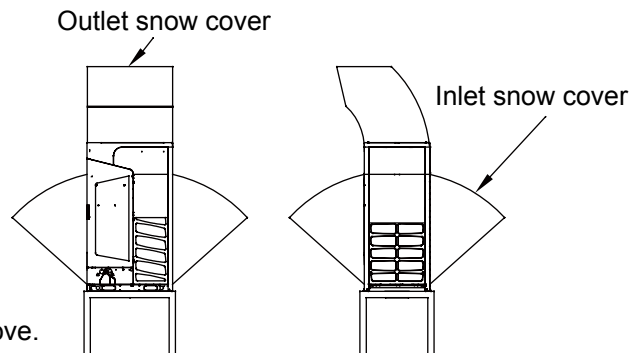

Panel disassembly instruction

Please refer to the following figure for the repair board to remove.

1. Remove the screw with a screwdriver and remove the repair wrench from the bottom of the machine (or use a self-prepared screwdriver).

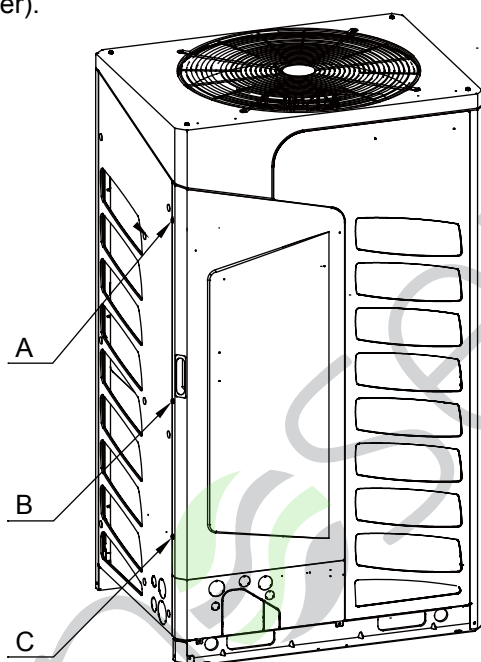

3. Along the direction of the arrow, after repair plate rotating about 40°, the maintenance from the fixed orifice plate on the right side of card claw, can complete repair plate disassembly.

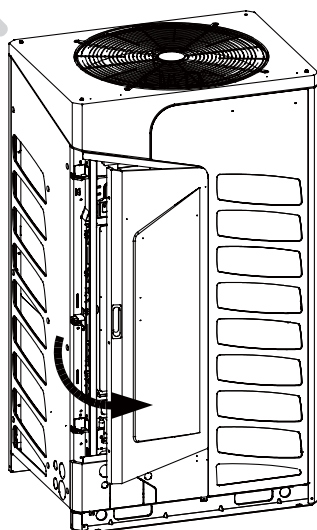

Install air ducting

There are no obstacles in the 2000mm above the outdoor unit; When there are obstacles in the outer plane, there must be a pilot channel, and the wind will be free, the wind will not be short-circuited, and the external static pressure will be 110Pa. Airway design dimensions are as follows:

Channel size (pattern 1)		
	AV08~16NMVETA	AV18~26NMVETA
A	The inner diameter 980	The inner diameter 1410
B	The inner diameter 750	The inner diameter 750
C	≤10000	≤10000
D	E+750	E+750
E	≥300	≥300
F	≥320	≥320

Channel size (pattern 2)		
	AV08~16NMVETA	AV18~26NMVETA
A	The inner diameter 750	The inner diameter 750
B	The inner diameter 980	The inner diameter 1410
C	≤10000	≤10000
D	E+980	E+1410
E	≥300	≥300
F	≥320	≥320

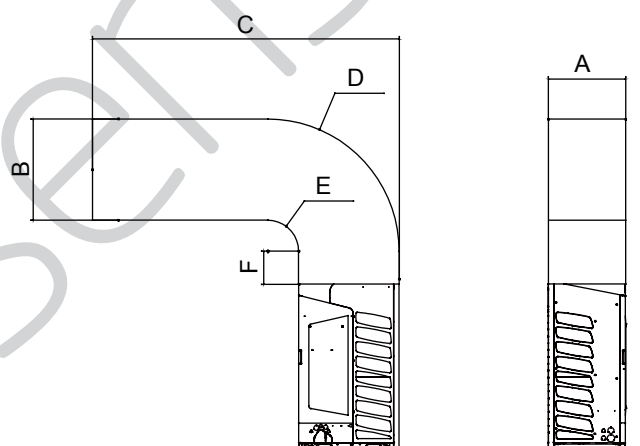
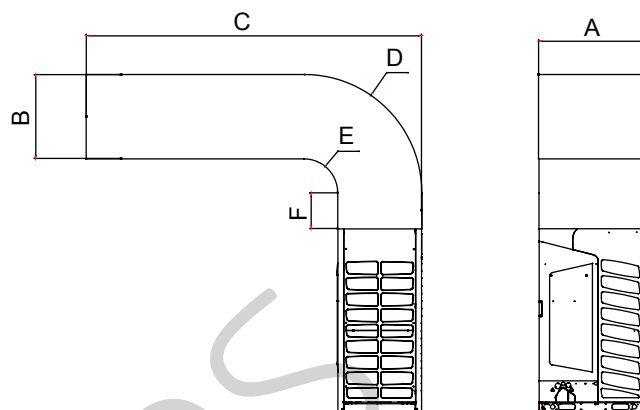

Note:

Before installing the wind channel, the unit should be removed from the wind protection network. At the same time, the outdoor air tube static press is set up to "have static pressure" mode. The above is just an example, the length of the wind tunnel should be calculated according to the shape of the wind channel.

14.3 Installation procedure

A. Refrigerant pipe connection

Pipe connection method:

- To ensure the efficiency, the pipe should be as short as possible.
- Daub the refrigerant oil on the connector and the flare nut.
- When bending the pipe, the bending semi-diameter should be as large as possible against the pipe being broken or bent.
- When connecting the pipe, aim at the center to thread the nut by hand and tighten it with the double spanners.
- Fastening torque please refers to "pipe specs and fastening torque" on page 15.
- Don't let the impurity such as sand, water etc into the pipe. Antifouling measures refer to Page 13.

When fastening and losing the nut, operate with double spanners, because only one spanner cannot execute firmly.

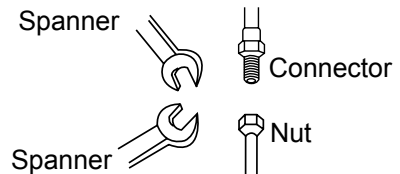

If threading the nut as not aiming at the center, the screw thread will be damaged, further it will cause leakage.

Cautions in piping installation:

1. When welding the pipe with hard solder, charge nitrogen into the pipe against oxidation. The pressure gauge should be set at 0.02MPa. Perform the procedure with nitrogen circulation. Otherwise, the oxide film in the pipe may clog the capillary and expansion valve resulting in accident.
2. The refrigerant pipe should be clean. If the water and the other impurity enter the pipe, charge the nitrogen to clean the pipe. The nitrogen should flow under the pressure of about 0.5MPa and when charging the nitrogen, stop up the end of the pipe by hand to enhance the pressure in the pipe, then loose the hand (meanwhile stop up the other end).
3. The piping installation should be executed after closing the stop valves.
4. When welding the valve and the pipe, cool down the valve with wet towel.
5. When the connection pipe and the branch pipe need to be cut down, please use the special shears and do not use the saw.
6. When welding copper pipe, use the phosphor copper welding rod without any welding flux. (welding flux will damage the piping system. The welding flux containing chlorine will corrode pipe, especially, the welding flux with fluorin will damage refrigeration oil.)

Pipe material and specs selection

1. Please select the refrigerant pipe of the below material.
Material: the phosphoric oxidize seamless copper pipe,
model: C1220T-1/2H (diameter is over 19.05); C1220T-0(diameter is below 15.88).
2. Thickness and specs:
Confirm the pipe thickness and specs according to the pipe selection method(the unit is with R410A, if the pipe over 19.05 is O-type, the pressure preservation will be bad, thus it must be 1/2H type and over the min. thickness.
3. The branch pipe and the gather pipe must be from Haier.
4. When installing the stop valve, refer to the relative operation instruction.
5. The pipe installation should be in the allowable range.
6. The installation of branch pipe and gather pipe should be performed according to the relative manual.

Anti-fouling measures

First, clean the pipe.

Position	Installation period	Measures
Outdoor	More than 1 month	Flat the pipe end
	Less than 1 month	Flat the pipe end or seal with adhesive tape
Indoor	Nothing to do with period	

Pipe specification

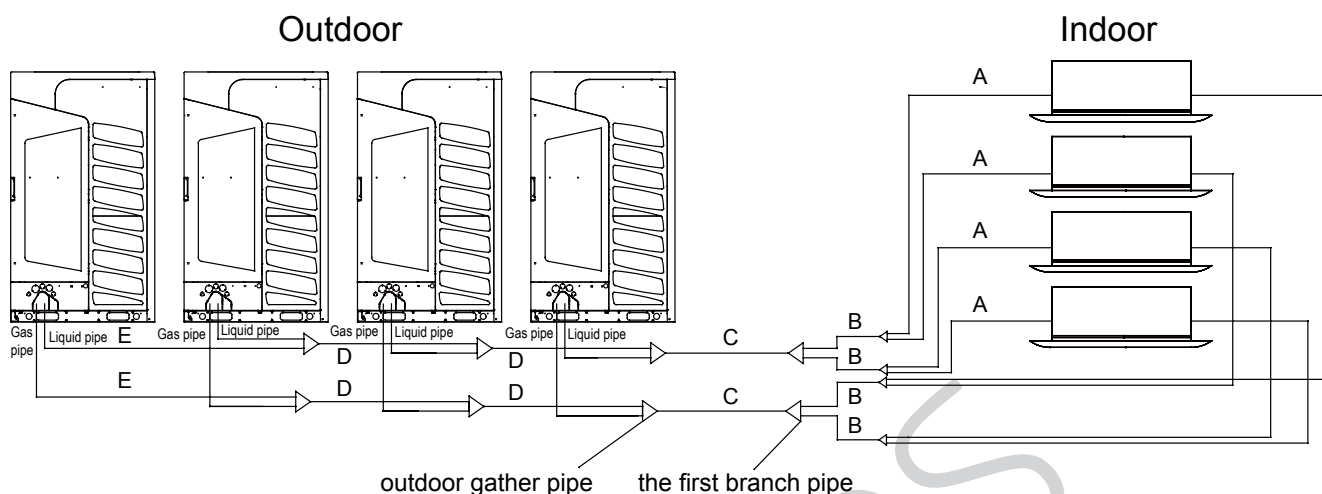

1. Pipe "A" diameter (between indoor and branch pipe) (depends on indoor pipe)

Indoor rated capacity (x100w)	Gas pipe	Connecting method	Liquid pipe	Connecting method	Note
15~28	Ø9.52	Flared	Ø6.35	Flared	AS07/092MGERA gas pipe should be Ø12.7 AS182MGERA gas / liquid pipe should be Ø15.88 / Ø9.52
36~56	Ø12.7		Ø6.35		
71~140	Ø15.88		Ø9.52		
226~300	Ø25.4	Ø9.52			
450~600	Ø28.58	Braze	Ø12.7		

(1) When pipe length between indoor & nearest branch pipe ≥ 15 m, adjust in accordance with following criteria:

- ① If indoor rated capacity ≤ 5.6 kW, change gas / liquid pipe diameter to Ø15.88 / Ø9.52
- ② If 16.8 kW \geq indoor rated capacity > 5.6 kW, change gas / liquid pipe diameter to Ø19.05 / Ø9.52
- ③ If indoor rated capacity > 16.8 kW, change liquid pipe diameter to Ø12.7

(2) When pipe length between first branch pipe & farthest indoor is over 40m, pipe b (between first branch pipe & farthest indoor) should be enlarged one size.

(3) The distance between the nearest indoor unit distance between the indoor unit ≤ 40 meters.

2. Pipe "B" diameter (between branch pipes)

Total indoor capacity after the branch pipe (kW)	Gas pipe	Liquid pipe
< 14 kW	According to the pipe A pipe diameter	
14 kW $\leq X < 16.8$ kW	Ø15.88	Ø9.52
16.8 kW $\leq X < 28.0$ kW	Ø19.05	Ø9.52
28.0 kW $\leq X < 33.5$ kW	Ø22.22	Ø9.52
33.5 kW $\leq X < 45.0$ kW	Ø28.58	Ø12.7
45.0 kW $\leq X < 71.0$ kW	Ø28.58	Ø15.88
71.0 kW $\leq X < 101.0$ kW	Ø31.8	Ø19.05
101.0 kW $\leq X < 158.0$ kW	Ø38.1	Ø19.05
158.0 kW $\leq X < 186.0$ kW	Ø41.3	Ø19.05
186.0 kW $\leq X < 240.0$ kW	Ø44.5	Ø22.22
240.0 kW $\leq X < 275.0$ kW	Ø50.8	Ø25.4
≥ 275 kW	Ø54.1	Ø25.4

3. Pipe “c” diameter (main pipe, between outdoor gather pipe and the first branch pipe)

Outdoor capacity (W)	Main pipe		Enlarged main pipe		Outdoor capacity (W)	Main pipe		Enlarged main pipe	
	Gas pipe	Liquid pipe	Gas pipe	Liquid pipe		Gas pipe	Liquid pipe	Gas pipe	Liquid pipe
25200	Ø19.05	Ø9.52	Ø22.22	Ø12.7	162400	Ø41.3	Ø19.05	Ø44.5	Ø22.22
28000	Ø22.22	Ø9.52	Ø25.4	Ø12.7	168000	Ø41.3	Ø19.05	Ø44.5	Ø22.22
33500	Ø25.4	Ø12.7	Ø28.58	Ø15.88	173500	Ø41.3	Ø19.05	Ø44.5	Ø22.22
40000	Ø25.4	Ø12.7	Ø28.58	Ø15.88	179000	Ø41.3	Ø19.05	Ø44.5	Ø22.22
45000	Ø28.58	Ø12.7	Ø31.8	Ø15.88	184500	Ø41.3	Ø19.05	Ø44.5	Ø22.22
50400	Ø28.58	Ø15.88	Ø31.8	Ø19.05	191000	Ø44.5	Ø22.22	Ø50.8	Ø25.4
56000	Ø28.58	Ø15.88	Ø31.8	Ø19.05	197500	Ø44.5	Ø22.22	Ø50.8	Ø25.4
61500	Ø28.58	Ø15.88	Ø31.8	Ø19.05	204000	Ø44.5	Ø22.22	Ø50.8	Ø25.4
68000	Ø28.58	Ø15.88	Ø31.8	Ø19.05	209500	Ø44.5	Ø22.22	Ø50.8	Ø25.4
73500	Ø28.58	Ø15.88	Ø31.8	Ø19.05	215000	Ø44.5	Ø22.22	Ø50.8	Ø25.4
80000	Ø28.58	Ø15.88	Ø31.8	Ø19.05	220500	Ø44.5	Ø22.22	Ø50.8	Ø25.4
85000	Ø31.8	Ø19.05	Ø38.1	Ø22.22	224000	Ø44.5	Ø22.22	Ø50.8	Ø25.4
90000	Ø31.8	Ø19.05	Ø38.1	Ø22.22	229500	Ø44.5	Ø22.22	Ø50.8	Ø25.4
95400	Ø31.8	Ø19.05	Ø38.1	Ø22.22	235000	Ø44.5	Ø22.22	Ø50.8	Ø25.4
100800	Ø38.1	Ø19.05	Ø38.1	Ø22.22	240500	Ø50.8	Ø25.4	Ø54.1	Ø25.4
106400	Ø38.1	Ø19.05	Ø38.1	Ø22.22	246000	Ø50.8	Ø25.4	Ø54.1	Ø25.4
112000	Ø38.1	Ø19.05	Ø38.1	Ø22.22	252500	Ø50.8	Ø25.4	Ø54.1	Ø25.4
117500	Ø38.1	Ø19.05	Ø38.1	Ø22.22	259000	Ø50.8	Ø25.4	Ø54.1	Ø25.4
123000	Ø38.1	Ø19.05	Ø38.1	Ø22.22	265500	Ø50.8	Ø25.4	Ø54.1	Ø25.4
129500	Ø38.1	Ø19.05	Ø38.1	Ø22.22	272000	Ø50.8	Ø25.4	Ø54.1	Ø25.4
136000	Ø38.1	Ø19.05	Ø38.1	Ø22.22	277500	Ø54.1	Ø25.4	Ø54.1	Ø25.4
141500	Ø38.1	Ø19.05	Ø38.1	Ø22.22	283000	Ø54.1	Ø25.4	Ø54.1	Ø25.4
147000	Ø38.1	Ø19.05	Ø38.1	Ø22.22	288500	Ø54.1	Ø25.4	Ø54.1	Ø25.4
151200	Ø38.1	Ø19.05	Ø41.3	Ø22.22	294000	Ø54.1	Ø25.4	Ø54.1	Ø25.4
156800	Ø38.1	Ø19.05	Ø41.3	Ø22.22					

Note: When the distance from outdoor to the longest indoor is over 90m, the main pipe diameter should be enlarged.

4. Pipe “D” diameter (between gather pipes)

5. Pipe “e” diameter (between outdoor and the gather pipe)

Total horse power of connected outdoors	Gas pipe	Liquid pipe	Outdoor (HP)	Gas pipe		Liquid pipe		Remarks
				Pipe diameter	Connection method	Pipe diameter	Connection method	
≤78.5kW	Ø28.58	Ø9.52	8	Ø19.05	Flared joint	Ø9.52	Flared joint	Please use the attached connection pipe diameter
85.0~96.0kW	Ø31.8	Ø19.05	10	Ø22.22	Brazing	Ø9.52		
101.0~157.0kW	Ø38.1	Ø19.05	12	Ø25.4		Ø12.7		
162.4~185.5kW	Ø41.3	Ø19.05	14	Ø25.4		Ø12.7		
192.0~235.0kW	Ø44.5	Ø22.22	16	Ø28.58		Ø12.7		
240.5~272.0kW	Ø50.8	Ø25.4	18	Ø28.58		Ø15.88		
> 272.0kW	Ø54.1	Ø25.4	20	Ø28.58		Ø15.88		
			22	Ø28.58		Ø15.88		
			24	Ø28.58		Ø15.88		
			26	Ø28.58		Ø15.88		

Allowable piping length and drop between indoor and outdoor

1. Pipe length between outdoors

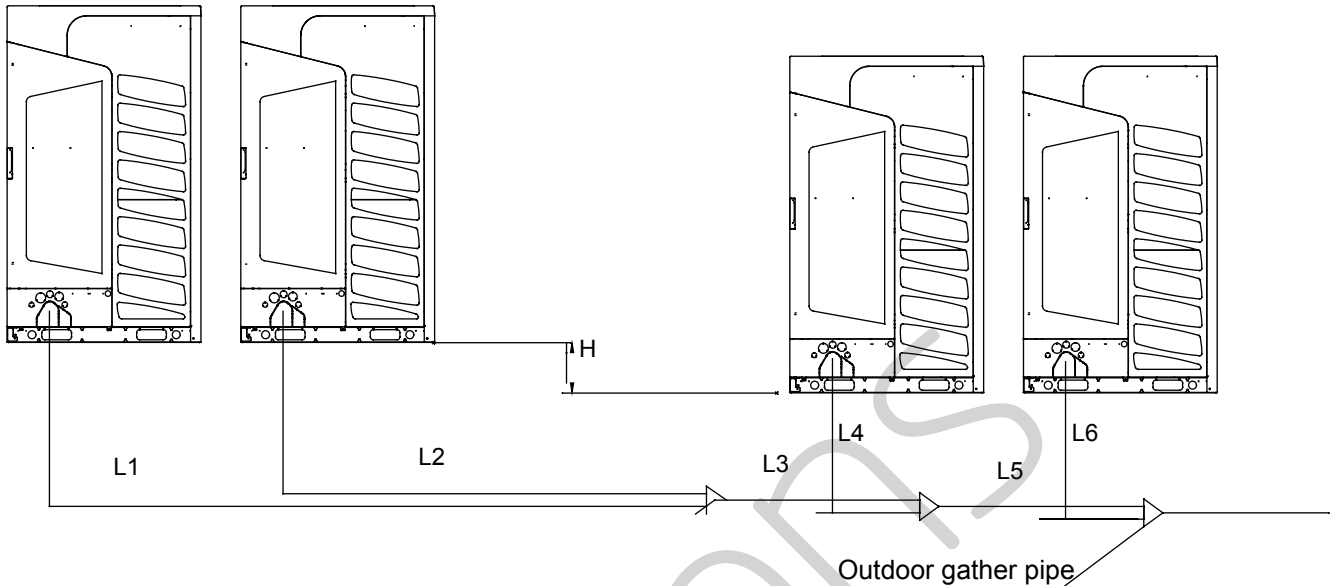

1. $L1 \leq 10\text{m}$; $L2 \leq 10\text{m}$; $L3 \leq 10\text{m}$; $L4 \leq 10\text{m}$; $L5 \leq 10\text{m}$; $L6 \leq 10\text{m}$; $L1 + L3 + L5 \leq 10\text{m}$.
2. Height difference between outdoors: $h \leq 5\text{m}$.
3. The piping connecting outdoor unit must be placed horizontally or in accordance with the installation of a certain angle (level angle less than 15 degrees), connected with a concave not allowed.
4. All piping cannot connect the outdoor unit is higher than the height of the machine outlet (valve interface part).

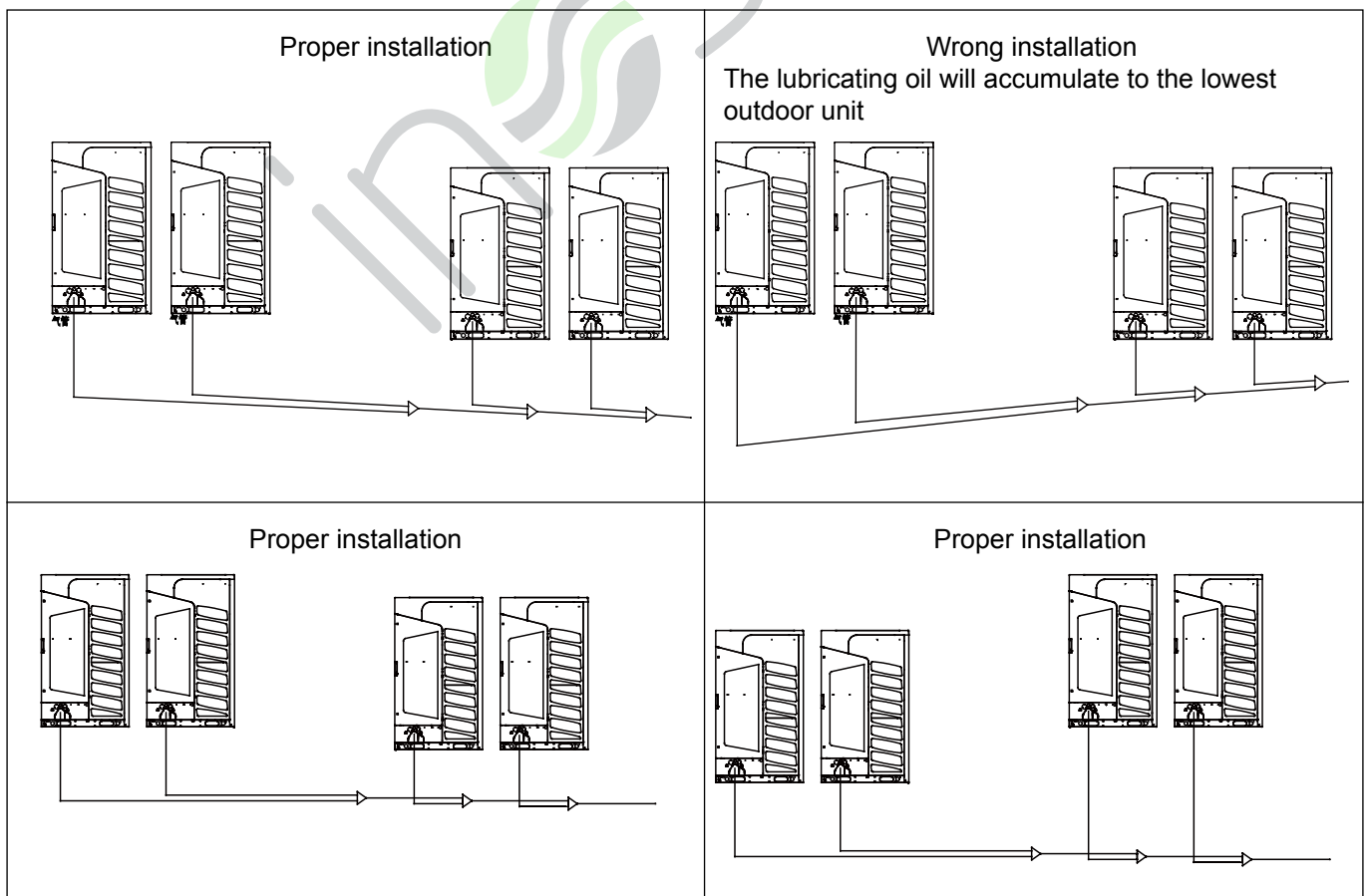

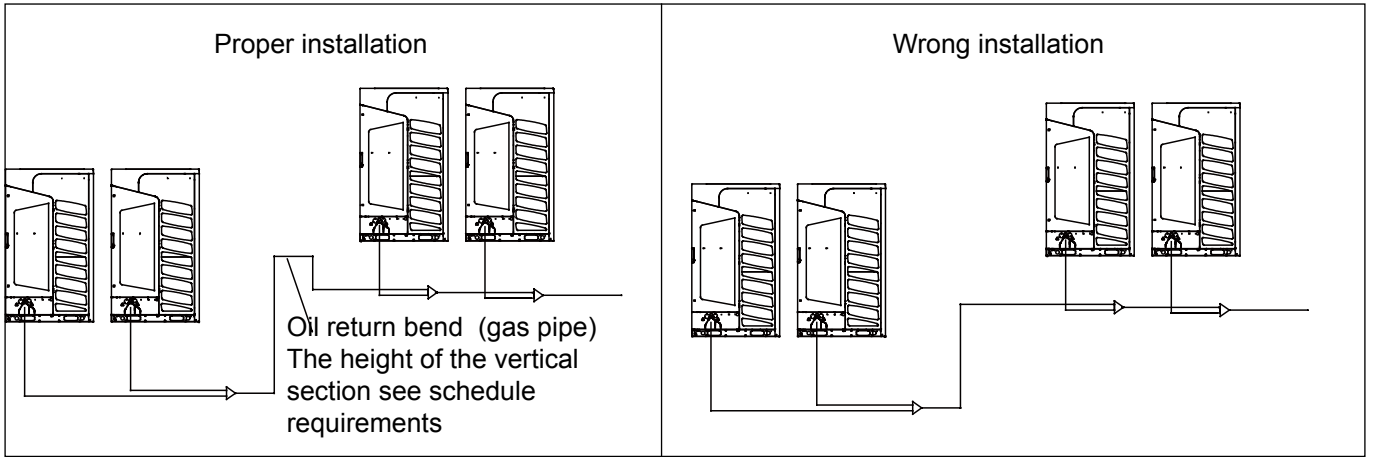

In order to avoid damage to the pipe, the size of the return bend is referred to as the drawing.

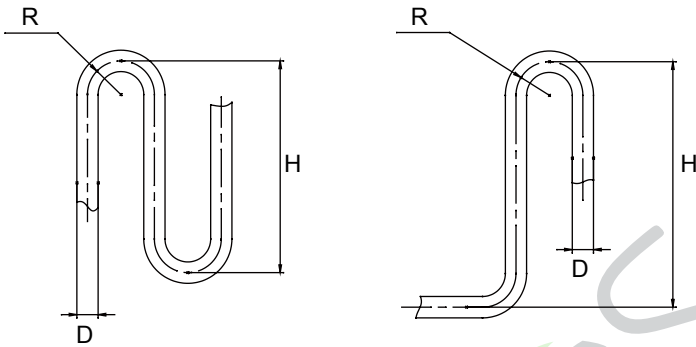

Pipe diameter D	Bending radius R	Vertical height H
Ø19.05	≥31	≤150
Ø22.22	≥31	≤150
Ø25.4	≥45	≤150
Ø28.58	≥45	≤150
Ø31.8	≥60	≤250
Ø38.1	≥60	≤350
Ø41.3	≥80	≤450
Ø44.5	≥80	≤500
Ø50.8	≥90	≤500
Ø54.1	≥90	≤500

2. Allowable piping length and drop between indoor and outdoor

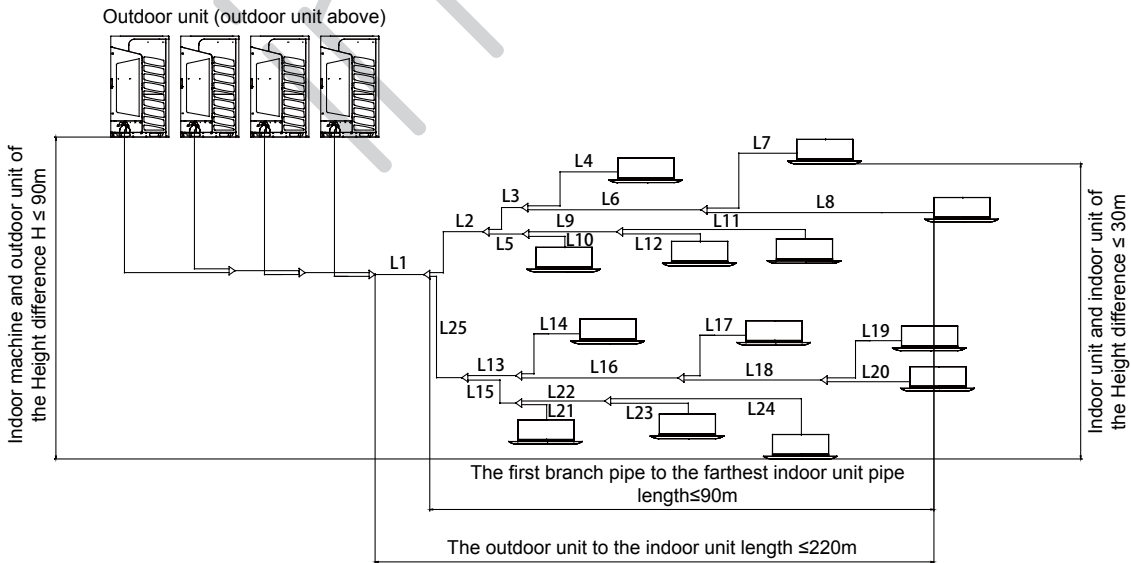

Pipe length and drop (m)		Allowable value	For example	Remarks
Total pipe length		≤ 1100	$L1+L2+L3+L4+\dots+L24$	
Outdoor to the farthest indoor length	Actual length	≤ 220	$L1+L2+L3+L6+L8$	
	Equivalent length	≤ 260		
The outdoor unit to the first branch pipe length (main piping)		≤ 130	$L1$	
The first branch pipe to the farthest indoor unit pipe length		≤ 90	$L2+L3+L6+L8$	
The distance between the nearest indoor unit and the farthest indoor		≤ 40	$L2+L3+L6+L8-L2-L5-L10$	
Height difference between indoor and outdoor H	Outdoor unit above	≤ 90	H	
	Outdoor unit under	≤ 110		
Indoor machine maximum drop h		≤ 30	h	
The indoor unit and the nearest branch length		≤ 10	$L4\setminus L8\setminus L9\setminus L10\setminus L11\setminus L12\setminus L14\setminus L17\setminus L19\setminus L20\setminus L21\setminus L23\setminus L24$	

Note:

Indoor unit as much as possible to install on both sides of the differences between the two sides.

Branch pipe

Branch pipe selection:

Total indoor capacity (100W)	Model (optional)
Less than 335	FQG-B335A
More than 335, less than 506	FQG-B506A
More than 506, less than 730	FQG-B730A
More than 730, less than 1360	FQG-B1350A
More than 1360	FQG-B2040A

Outdoor unit type

The master unit will choose the closest one to the 1st branch pipe.

Note:

- When connecting the gather pipe and the outdoor, please pay attention to the outdoor pipe dimension.
- When adjusting the diameter among gather pipes and among the units, please must execute at the branch pipe side.
- Please install the gather pipe (gas/liquid side) in horizontal or vertical direction.
- When welding with hard solder, please must blow nitrogen. If not, a number of oxide will be produced and cause heavy damage. Besides, to prevent water and dust into the pipe, please make the brim as outer roll.

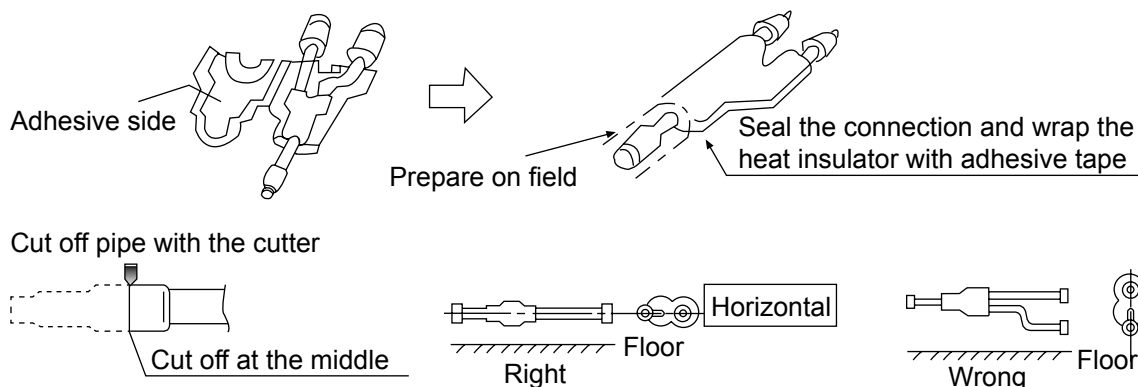

Pipe installation

Important

- Please don't let the pipe and the parts in the unit collide each other.
- When connecting the pipes, close the valves fully.
- Protect the pipe end against the water, impurity into the pipes (welding after being flat, or being sealed with adhesive tape).
- Bend the pipe as large semi-diameter as possible(over 4 times of the pipe diameter).
- The connection between outdoor liquid pipe and the distributing pipe is flared type. Please expand the pipe with the special tool for R410A after installing the expanding nut. But if the projecting pipe length has been adjusted with the copper pipe gauge, you can use the original tool to expand the pipe.
- Since the unit is with R410A, the expanding oil is ester oil, not the mineral oil.
- When connecting the expanding pipe, fasten the pipes with double-spanner. The torque refers to the former info.

Expanding pipe: A(mm)		Projecting length of pipe to be expanded: B(mm)		
Pipe outer diameter (mm)	A ⁰ _{-0.4}	Pipe outer diameter (mm)	When it is hard pipe	
			Special tool for R410A	The former tool
Ø6.35	9.1	Ø6.35	0-0.5	1.0-1.5
Ø9.52	13.2	Ø9.52		
Ø12.7	16.6	Ø12.7		
Ø15.88	19.7	Ø15.88		

- The outdoor gas pipe and the refrigerant distributing pipe, as well the refrigerant distributing pipe and the branch pipe should be welded with hard solder.
- Weld the pipe at the same time charge the nitrogen. Or it will cause a number of impurity (a film of oxidation) to clog the capillary and the expansion valve, further cause the deadly failure.

Operation procedure

- Weld the pipe at the same time charge the nitrogen. Or it will cause a number of impurity (a film of oxidation) to clog the capillary and the expansion valve, further cause the deadly failure.

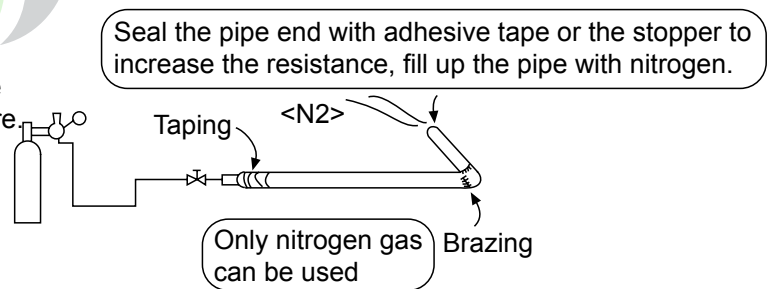

- Protect the pipe end against water and impurities (welding after being flattened, or being sealed with adhesive tape).

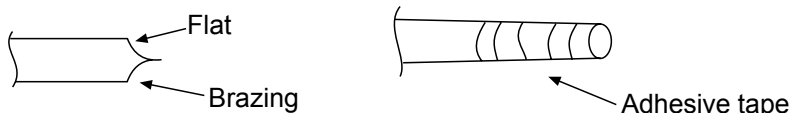

- The refrigerant pipe should be clean. The nitrogen should flow under the pressure of about 0.5MPa and when charging the nitrogen, stop up the end of the pipe by hand to enhance the pressure in the pipe, then loose the hand (meanwhile stop up the other end).

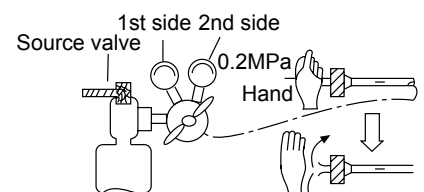

- When connecting the pipes, close the valves fully.

- When welding the valve and the pipes, use the wet cloth to cool down the valve and the pipes.

B. Leakage test

1. The outdoor unit has been executed the leakage test in the factory. The pipe should be executed leakage test individually and forbidden to test after connecting with stop valve.
2. Refer to the below figure to charge the nitrogen into the unit to take a test. Never use the chlorin, oxygen, flammable gas in the leakage test. Apply pressure both on the gas pipe and the liquid pipe.
3. Apply the pressure step by step to the target pressure.
 - a. Apply the pressure to 0.5MPa for more than 5 minutes, confirm if pressure goes down.
 - b. Apply the pressure to 1.5MPa for more than 5 minutes, confirm if pressure goes down.
 - c. Apply the pressure to the target pressure (4.15MPa), record the temp. and the pressure.
 - d. Leave it at 4.15MPa for over 1 day, if pressure does not go down, the test is passed. Meanwhile, when the temp. changes for 1degree, pressure will change 0.01MPa as well. Correct the pressure.
 - e. After confirmation of a~d, if pressure goes down, there is leakage. Check the brazing position, flared position by laying on the soap. Modify the leakage point and take another leakage test.
4. After leakage test, do execute the evacuation.

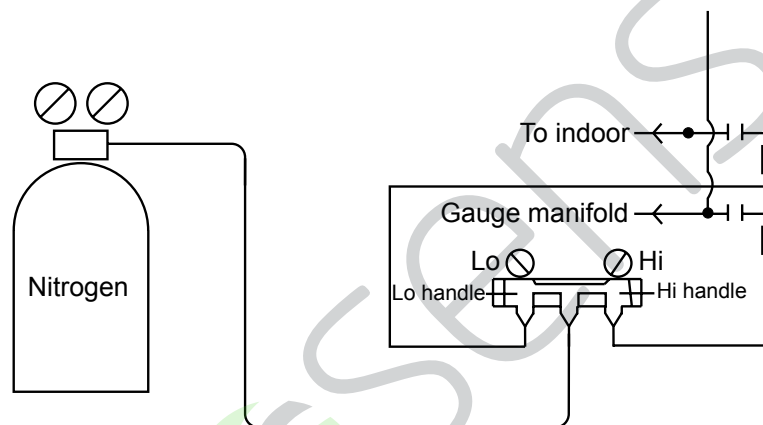

C. Evacuation

Evacuate at the check valve of liquid stop valve and both sides of the gas stop valve. The oil equalization pipe also must be vacuum (executed at the oil equalization pipe and check valve respectively).

Operation procedure:

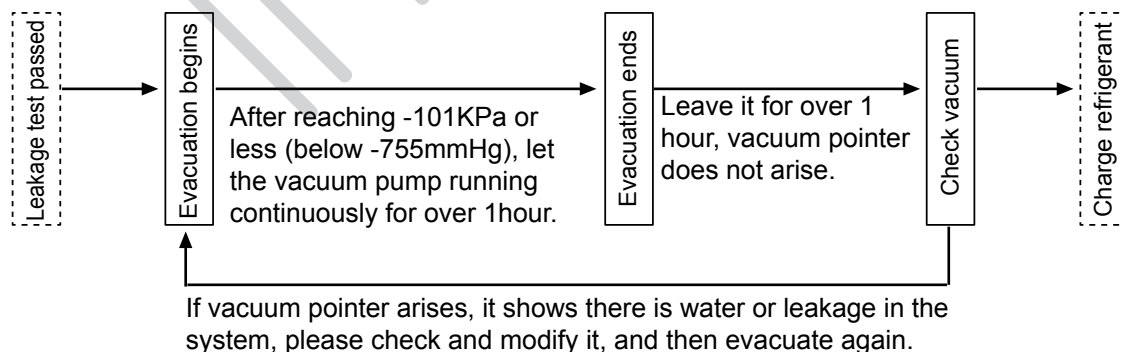

Because the unit is with refrigerant R410A, the below issues should be paid attention:

- To prevent the oil going into the pipe, please use the special tool for R410A, especially for gauge manifold and charging hose.
- To prevent the oil going into the refrigerant cycle, please use the anti-counter-flow adapter.
- When maintaining the outdoor, release refrigerant from check valve. When taking vacuum evacuation, set the relative dip switch. The details refer to Code section.

Tighten torque as the table below:

Stop valve diameter (mm)	Fastening torque (N.m)	Fastening angle (°)	Recommended tool length (mm)
Ø6.35	14~18	45~60	150
Ø9.52	34~42	30~45	200
Ø12.7	49~61	30~45	250
Ø15.88	68~82	15~20	300
Ø19.05	84~98	15~20	300

D. Additional refrigerant charging

Charge the additional refrigerant as liquid state with the gauge.

If the additional refrigerant can not be charged totally when the outdoor stops, charge it at the trial mode.

If the unit runs for a long period in the state of lack of refrigerant, compressor will occur failure.

(the charging must be finished within 30 minutes especially when the unit is running, meanwhile charging the refrigerant).

The unit is charged only part of the refrigerant at the factory, also need additional refrigerant at the installation site.

W1: Refrigerant charging volume to outdoor unit at factory.

W2: Refrigerant charging volume to outdoor unit on site.

W3: Refrigerant charging volume to liquid pipe base on different piping length calculation.

W3=actual length of liquid pipe×additional amount per meter liquid pipe=

$(L1 \times 0.52) + (L2 \times 0.35) + (L3 \times 0.25) + (L4 \times 0.17) + (L5 \times 0.11) + (L6 \times 0.054) + (L7 \times 0.022)$

L1: Total length of 25.4 liquid pipe; L2: Total length of 22.22 liquid pipe; L3: Total length of 19.05 liquid pipe;

L4: Total length of 15.88 liquid pipe; L5: Total length of 12.7 liquid pipe; L6: Total length of 9.52 liquid pipe;

L7: Total length of 6.35 liquid pipe

Total refrigerant volume charging on site during installation = W2 + W3

W: Total refrigerant volume charging on site for maintenance.

Refrigerant record form						
Model	W1: Refrigerant charging volume to outdoor unit at factory	W2: Refrigerant charging volume to outdoor unit on site	W3: Refrigerant charging volume to liquid pipe base on different piping length calculation		Total refrigerant volume charging on site during installation	W: Total refrigerant volume charging on site for maintenance
			Liquid pipe diameter (mm)	Additional refrigerant amount (kg)		
8HP	10kg	1kg	Ø6.35	$0.022\text{kg/m} \times __ \text{m} = __ \text{kg}$	W2+W3= ___ kg	W1+W2+W3= ___ kg
10HP	10kg	1kg	Ø9.52	$0.054\text{kg/m} \times __ \text{m} = __ \text{kg}$		
12HP	10kg	1kg	Ø12.7	$0.11\text{kg/m} \times __ \text{m} = __ \text{kg}$		
14HP	10kg	1kg	Ø15.88	$0.17\text{kg/m} \times __ \text{m} = __ \text{kg}$		
16HP	10kg	1kg	Ø19.05	$0.25\text{kg/m} \times __ \text{m} = __ \text{kg}$		
18HP	10kg	3.5kg	Ø22.22	$0.35\text{kg/m} \times __ \text{m} = __ \text{kg}$		
20HP	10kg	3.5kg	Ø25.4	$0.52\text{kg/m} \times __ \text{m} = __ \text{kg}$		
22HP	10kg	4.5kg	W3= ___ kg			
24HP	10kg	4.5kg				
26HP	10kg	5kg				

Note:

- To prevent the oil going into the pipe, please use the special tool for R410A, especially for gauge manifold and charging hose.
- Mark the refrigerant type in different colour on the tank. R410A is pink.
- Must not use the charging cylinder, because the R410A will change when transferring to the cylinder.
- When charging refrigerant, the refrigerant should be taken out from the tank as liquid state.
- Mark the counted refrigerant volume due to the distributing pipe length on the label.

- This product contains fluorinated greenhouse gases in hermetically sealed system. Do not vent into the atmosphere. Refrigerant type: R410A. See the table above for the mass of charged refrigerant. GWP (Global Warming Potential): 2088.
- A leak check for refrigerant shall be carried out at least every 12 months and by natural persons certified in accordance with the European rules.

Heat insulation

- HP gas pipe, Suction gas pipe and liquid pipe should be heat insulated separately.
- The material for HP gas pipe and Suction gas pipe should endure the high temperature over 120°C. That for liquid pipe should be over 70°C.
- The material thickness should be over 10mm, when ambient temp. is 30°C, and the relative humidity is over 80%, the material thickness should be over 20mm.
- The material should cling the pipe closely without gap, then be wrapped with adhesive tape. The connection wire can not be put together with the heat insulation material and should be far at least 20cm.

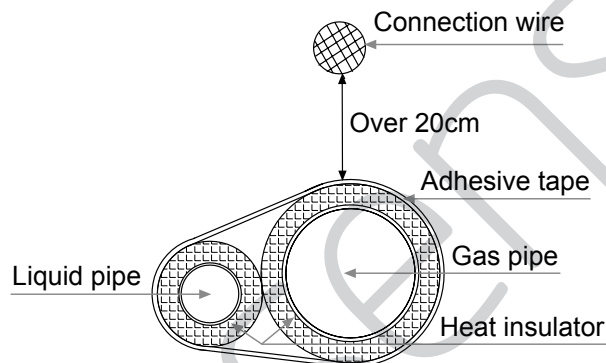

Fix the refrigerant pipe

- In operation, the pipe will vibrate and expand or shrink. If not being fixed, the refrigerant will focus on one part to cause the broken pipe.
- To prevent the central stress, fix the pipe for every 2-3m.

14.4 Electric wiring and the application

Note:

1. Please follow the national electrical standards, all provided parts, raw materials must comply with local laws and regulations. And please professional electrician installation.
2. Power supply must use the rated voltage and air conditioning unit dedicated power supply, power fluctuations in the power supply ratio of less than 2%, and were designed indoor unit, outdoor machine dedicated power.
3. The power cord should be reliably fastened to prevent the terminals from being stressed. Please do not force the power cord.
4. The power line diameter should be large enough, the ground wire should be reliable, should be connected to the building's special grounding device.
5. The air switch and earth leakage switch that can be cut off the entire system must be installed. Air switch should also have a magnetic trip and thermal trip function to ensure that short circuit and overload are protected, Should use "D" type circuit breaker.
6. Do not add the phase-connected capacitor to prevent overheating of the capacitor due to high frequency waves.
7. Please follow the instructions in accordance with the requirements of the power cord connection, so as to avoid a security incident.
8. The unit must be reliably grounded to meet the relevant requirements of GB 50169.
9. All electrical installations must be carried out by professionals in accordance with local laws, regulations and corresponding instructions.

Power

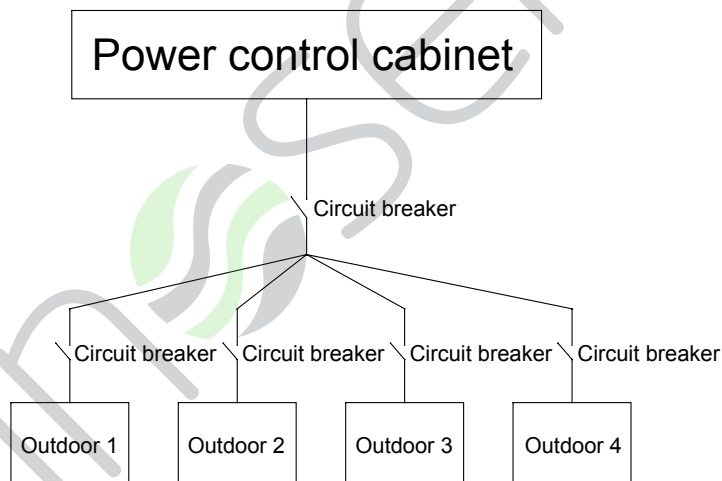

Outdoor Power Supply:

380V/3Ph/50-60HZ

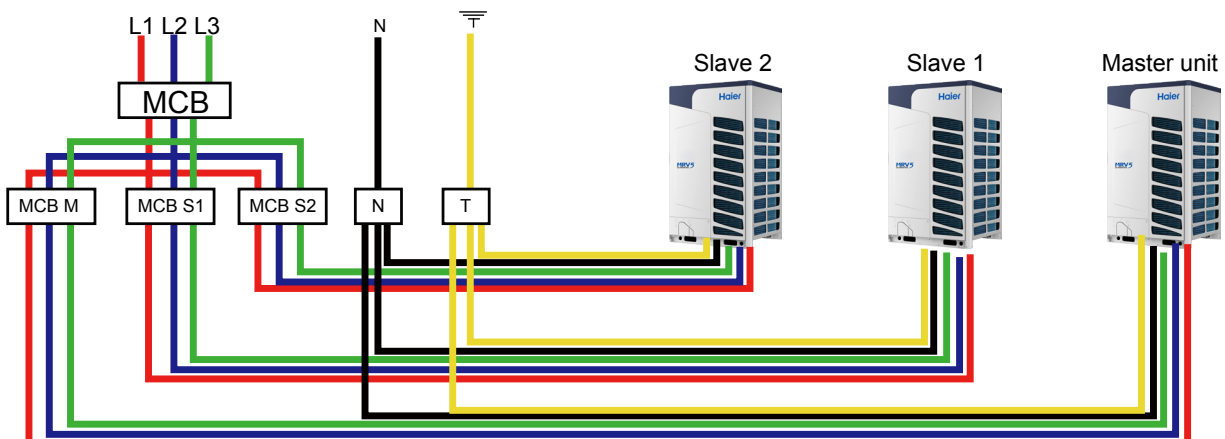

Indoor Power Supply:

230V/1Ph/50-60HZ

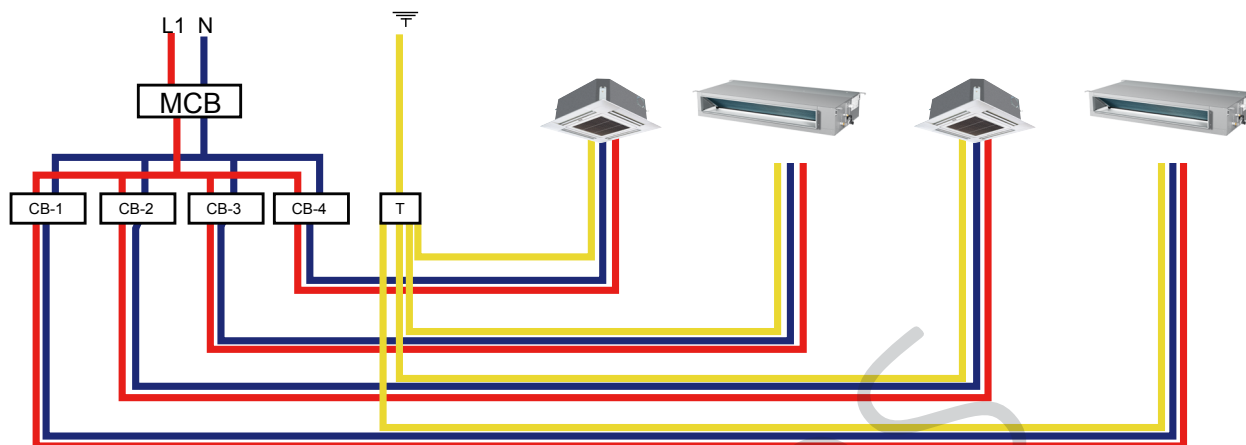

Outdoor unit leakage protection switch and circuit breaker

Model	Power source	Maximum load current (A)	Circuit breaker	Each module circuit breaker	Leakage current (mA) response time(S)	Minimum sectional area of power line (mm ²)	Minimum sectional area of earthing line (mm ²)
AV08NMVETA	3N~, 380-415V, 50/60Hz	20.3	25	25	30mA, below 0.1s	6	4
AV10NMVETA		21.8	25	25		6	4
AV12NMVETA		23.3	32	32		10	4
AV14NMVETA		27.7	40	40		10	4
AV16NMVETA		32.4	40	40		10	4
AV18NMVETA		36.1	50	50		16	6
AV20NMVETA		42.4	63	63		16	6
AV22NMVETA		48.1	63	63		25	10
AV24NMVETA		49.1	63	63		25	10
AV26NMVETA		55.8	63	63		25	10

Note:

1. Unit power cord must be 5 core copper cable, the operating temperature can not be greater than its specified value.
2. If the power cord length is greater than 20m, please increase the cable cross-sectional area, so as to avoid overload caused by the accident.
3. When the voltage drop at the power supply line exceeds 2%, increase the wire diameter appropriately.
4. The air switch and power line is calculated according to the maximum power of the unit, and the combination in accordance with the provisions of the combination of different combinations of modules need to follow the specific parameters of the combination module. The new calculation and calculation method refer to the electrician manual.

Power line installation instructions

1. Air conditioning unit is I class appliance, please be sure to take reliable grounding measures.
2. Earth resistance should meet the national standard GB 50169 requirement.
3. The yellow and green double color line of air conditioning unit is ground wire, do not move for other use, do not cut it. Cannot be fixed with self-tapping screw. Otherwise, the risk of electric shock will be electric.
4. The user's power supply must provide reliable grounding. Please don't connect the ground wire to the following places. (1) water pipe (2) gas pipe; (3) drainage pipe; (4) The other places where professionals think are unreliable.
5. The power cord and the communication line should not be interwoven together, the distance should be greater than 20cm apart, or it may cause the crew communication to be abnormal.

Please follow the following guidelines:

Note:

Please connect the power cord with the appropriate circular terminal. PQ is non-polar, ABC has polarity, must be correct when connecting. The route is as follows:

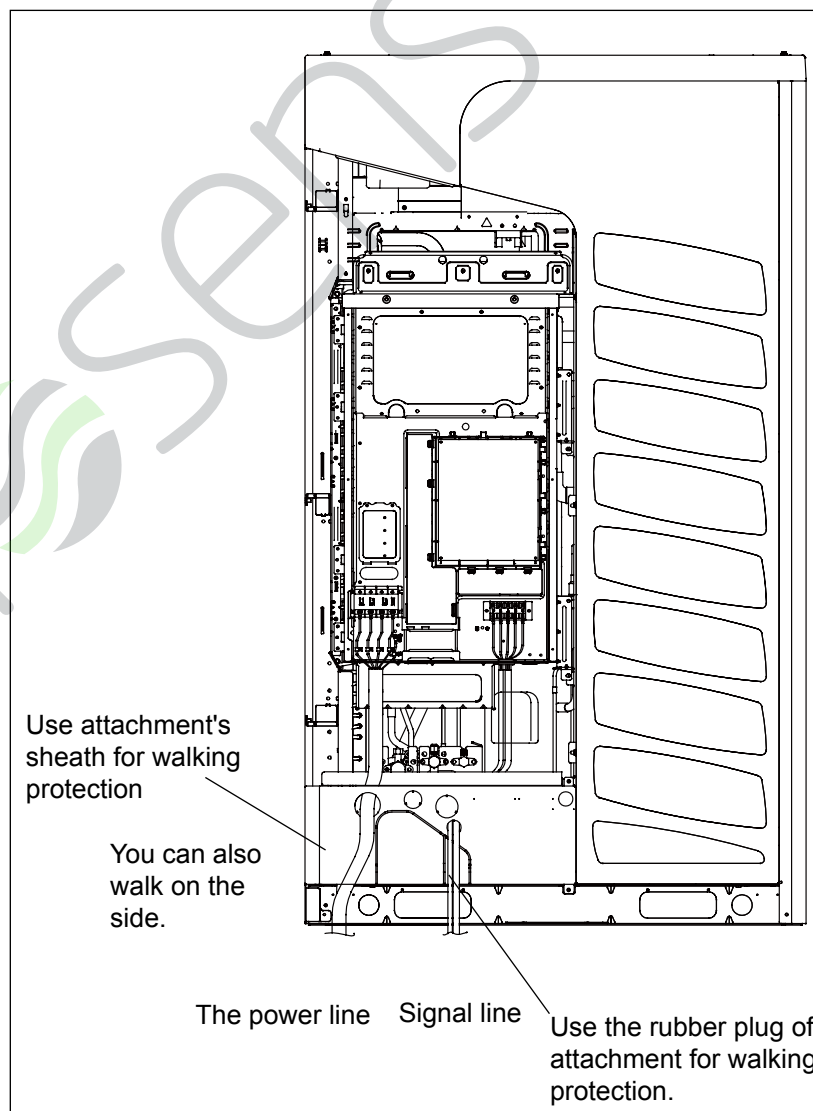
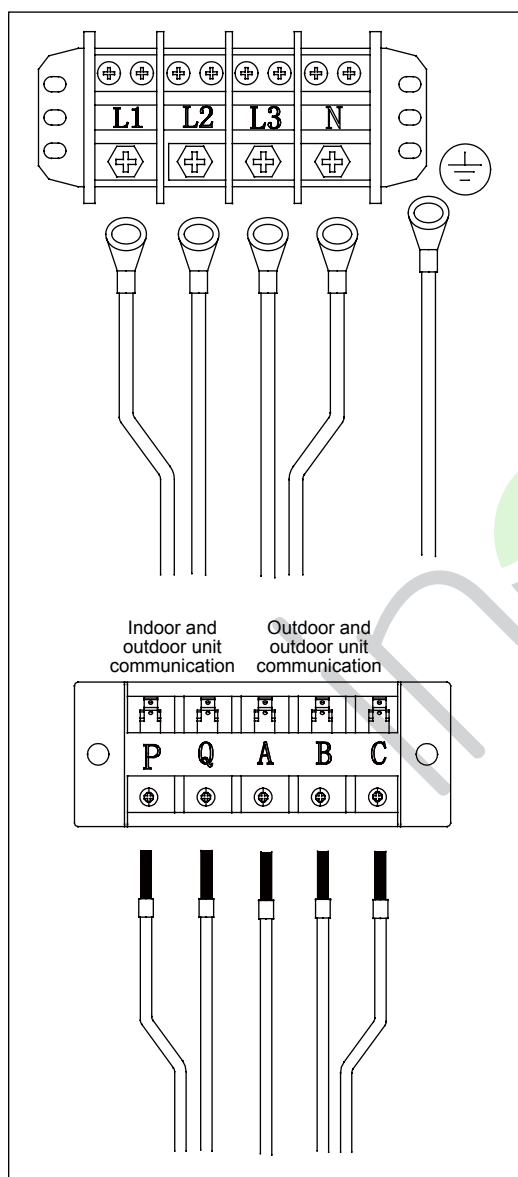

Power line installation instructions

Note:

When connecting the power cord, please be sure to set aside enough length in the outdoor, which is convenient for turning over the electrical box.

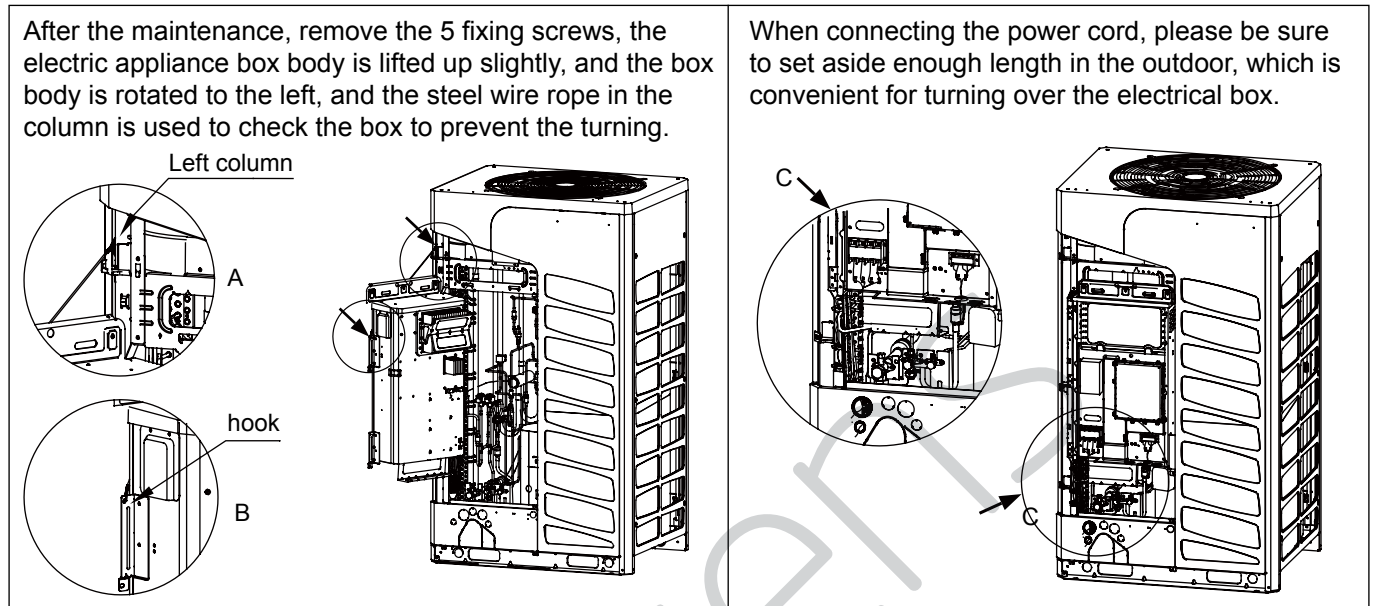

Communication wiring figure (Wired)

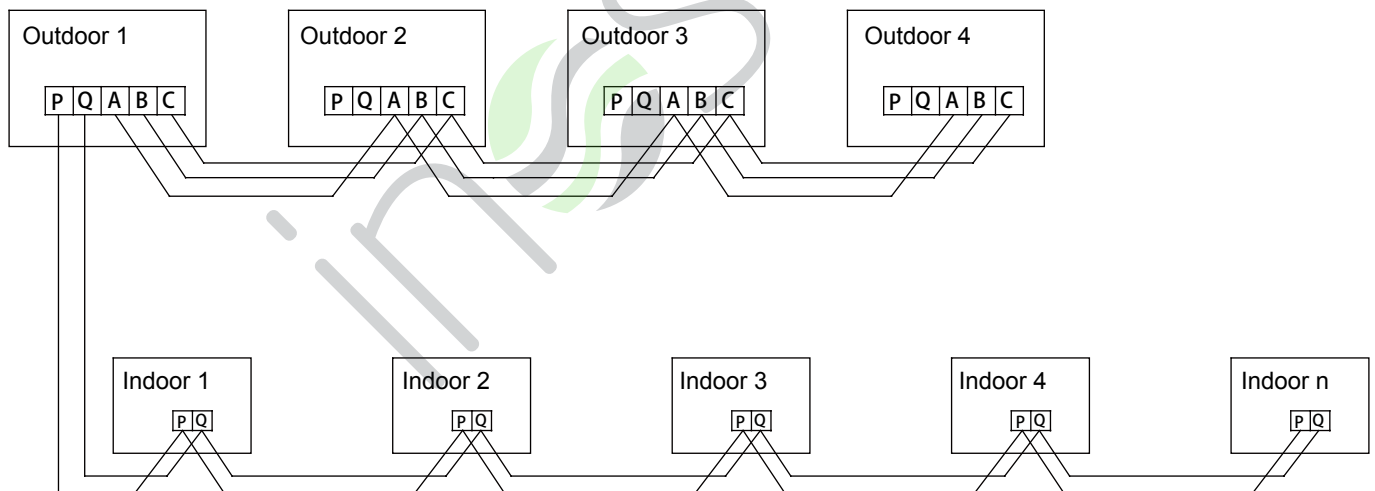

Note:

- Outdoor using 3 core, 0.75m² shielding wire connection, polarity
- Indoor using 2 core, 0.75m² shielding wire connection, non polarity. The signal line shield must be grounded at one end, and the communication line between the indoor and outdoor machine is 1500 meters long.
- The communication line must be hand-in-hand serial connection, not using star connection.
- When the length of the single line of communication is not sufficient, the joint connection must be pressed or solder.

Communication wiring figure (wireless)

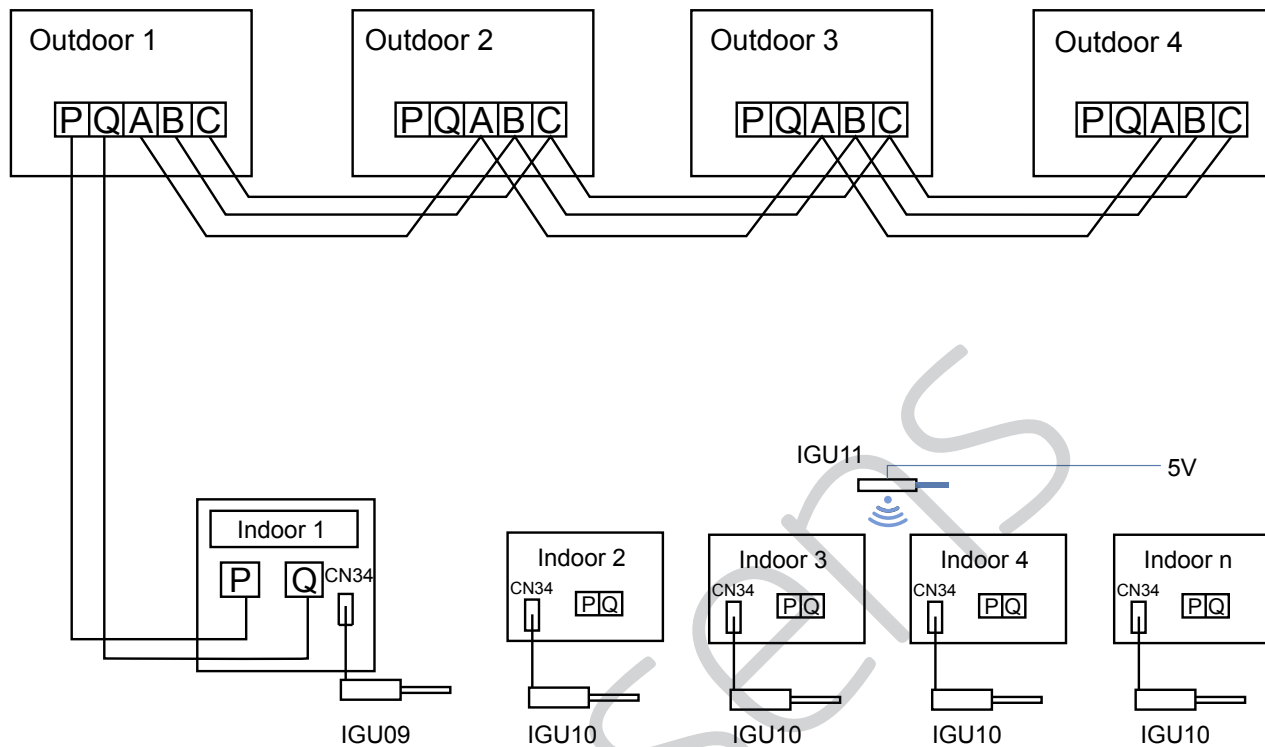

Note:

If the system unit adopts Zigbee wireless communication, it must adopt wireless and wired hybrid mode. The PQ cable must be connected to the IDU which one with the smallest address number

15. Branch pipe dimension

Unit: mm ID: inner diameter OD: outer diameter

Model	Gas side branch pipe	Liquid side branch pipe	Gas side connection of branch pipe	Liquid side connection of branch pipe
FQG-B335A				
FQG-B506A				
FQG-B730A				

16. Gather pipe dimension

Gather pipe is used for combination of outdoor unit. HZG-20B (for 2 basic modules); HZG-30B(for 3 basic modules). Unit: mm, ID: inner diameter; OD: outer diameter. Note: Cut off the pipe from its middle when using

Model	Side	Mark	Gather pipe	Connection of gather pipe
HZG-20B	Suction gas side	(A)		
	Liquid side	(B)		
HZG-30B	Suction gas side	(C)		<p>double</p>
		(D)		
	Liquid side	(E)		
		(F)		<p>double</p>

17. Trial operation

17.1 Confirmation by electrifying

No.	Contents to be confirmed	Result
1	Whether there is power on interface board of the outdoor unit, whether the digital tube is displaying and whether the displayed data on dip switch panel and the tube are variable.	
2	For MRV outdoor unit, indoor unit number displayed on the digital tube is consistent with the actual number when dip switch panels SW1, SW2 and SW3 are turned to "0 3 2", and dip switch code BM1-2 is turned from OFF to ON.	
3	For MRV outdoor unit system, outdoor unit number displayed on the digital tube is consistent with the actual number when dip switch panels SW1, SW2 and SW3 are turned to "0 2 2", and dip switch code BM1-1 is turned from OFF to ON.	
4	For MRV outdoor unit system, the HP of outdoor unit sets displayed on the digital tube is consistent with the actual unit type when dip switch panels SW1, SW2 and SW3 are turned to "0 1 2" AV08NMVETA shows "1-8.0" AV10NMVETA shows "1-10.0" AV12NMVETA shows "1-12.0" AV14NMVETA shows "1-14.0" AV16NMVETA shows "1-16.0" AV18NMVETA shows "1-18.0" AV20NMVETA shows "1-20.0" AV22NMVETA shows "1-22.0" AV24NMVETA shows "1-24.0" AV26NMVETA shows "1-26.0"	
5	Check whether the parameters, such as parameters of outdoor unit sensors, number of indoors connected and the opening of electronic expansion valves, etc., are correct through dip switch on the outdoor unit interface board or by using testing equipment and computer software.	
6	Check whether the parameters, such as parameters of indoor unit sensors, the opening of electronic expansion valves, etc., are correct through dip switch on the outdoor unit interface board or by using testing equipment and computer software.	

Note: If the indoor unit cannot be searched or the number of the searched units isn't consistent with the actual number of indoor units in the system within four and a half minutes, it will be reported as communication fault 26-X.

17.2 Rated operation

Startup control on indoor and outdoor units and operation condition inspection for outdoor units can be completed through rated operation. In case of inspection on single indoor unit, wired controller or remote controller of indoor unit will be adopted for control.

Rated cooling operation: when SW1, SW2 and SW3 dip switches are turned to 0, 13, 2, the indoor units will be started up automatically and be forced to turn to cooling operation.

Rated heating operation: when SW1, SW2 and SW3 dip switches are turned to 0, 14, 2, the indoor units will be started up automatically and be forced to turn to heating operation.

17.3 Trial operation confirmation

The test run confirmation, in principle, shows that all the indoor units should be confirmed one by one. The improper connection of refrigeration pipe and control wire cannot be confirmed when all the indoor units are running simultaneously. So all the other indoor units should be set in "stopped condition".

A. Main power supply and initial confirmation

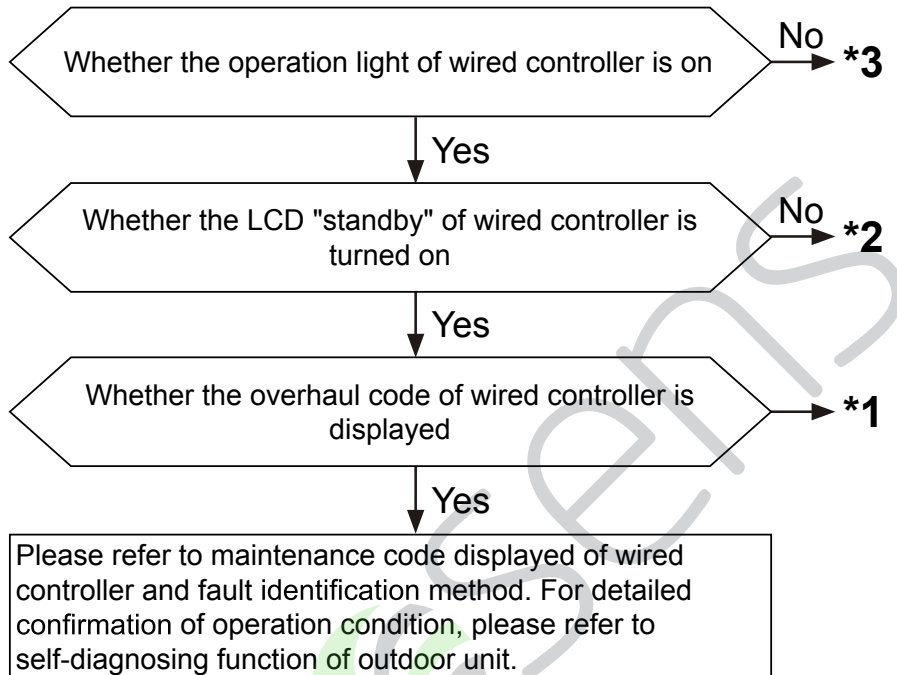

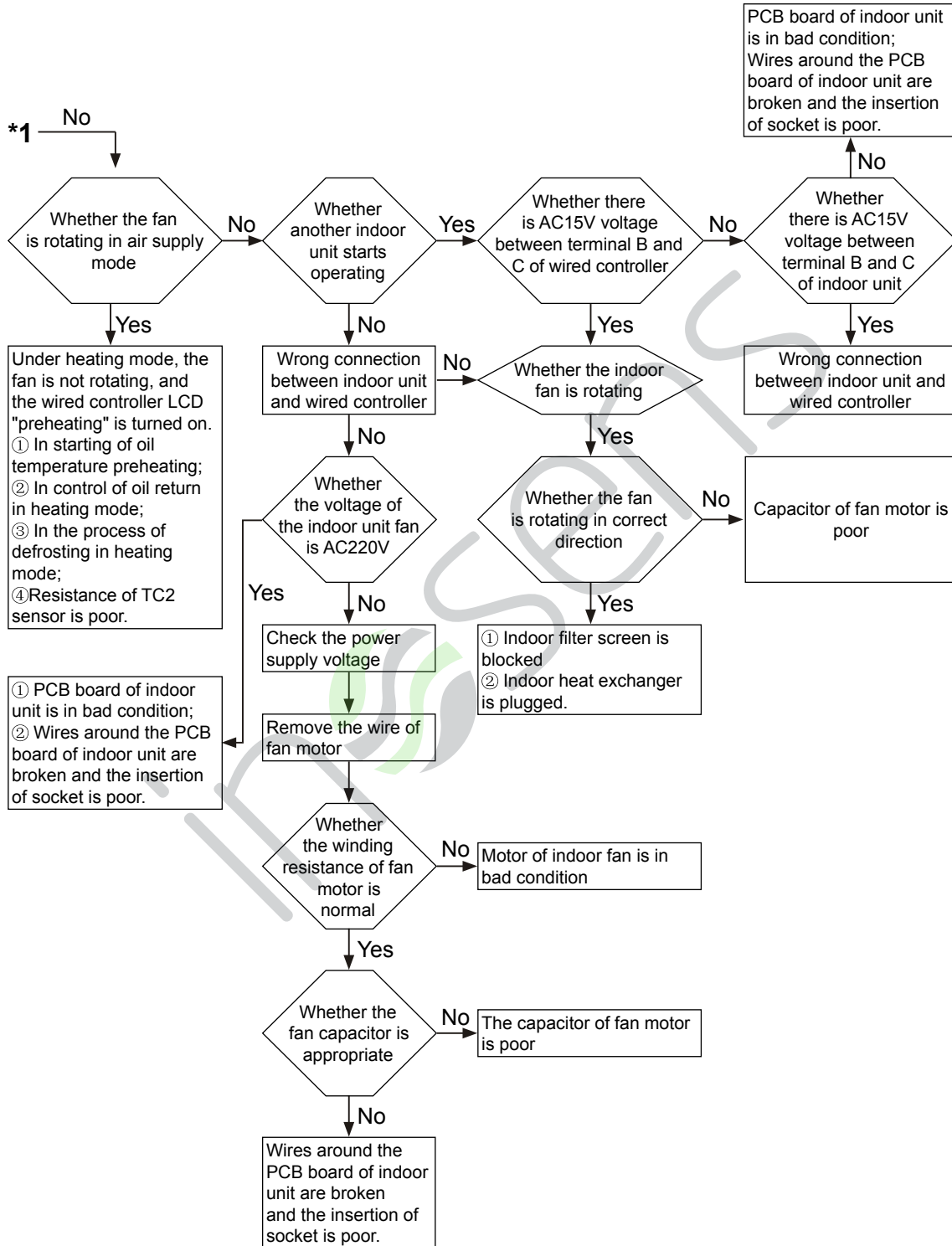

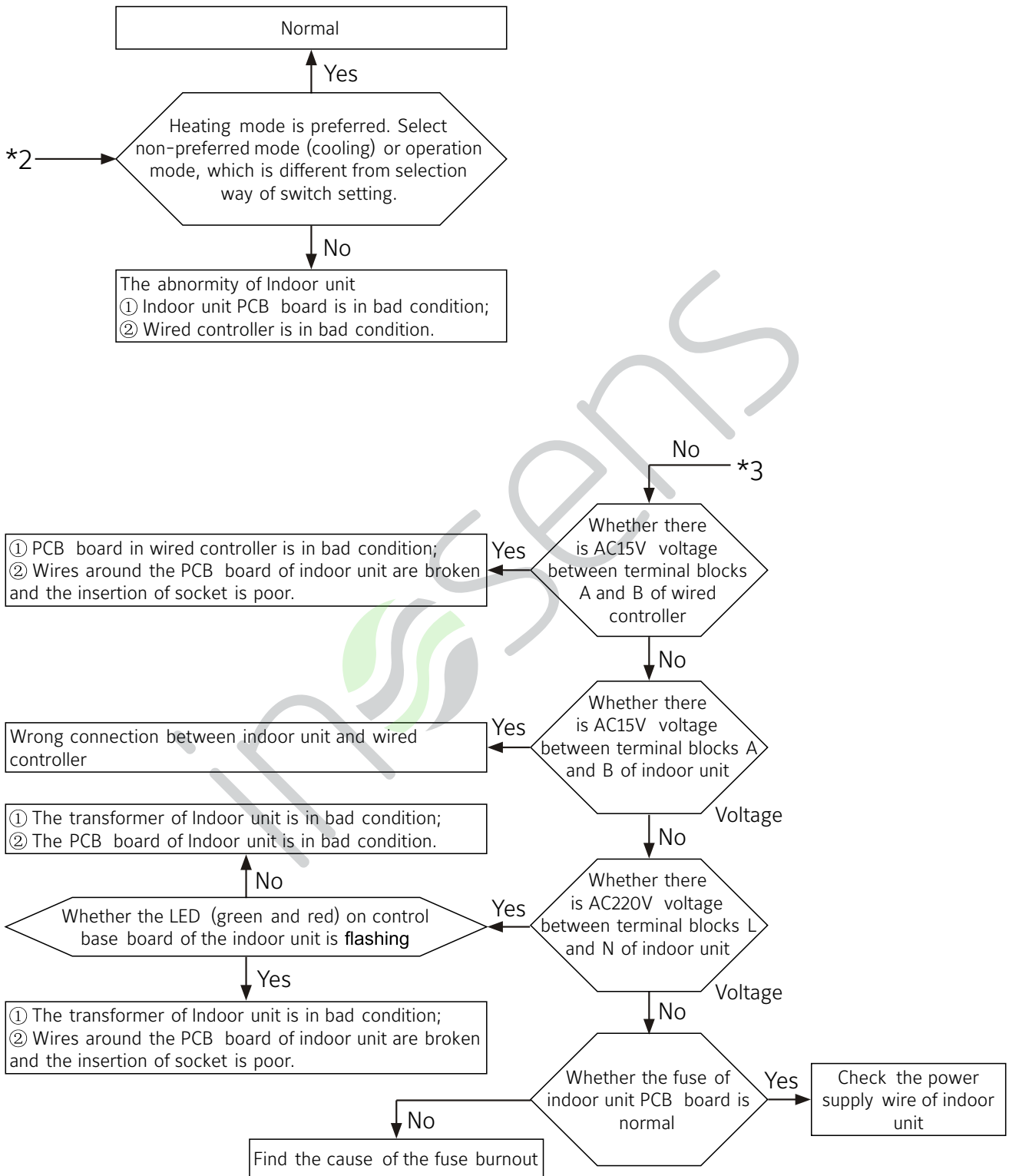

B. Air blower operation confirmation

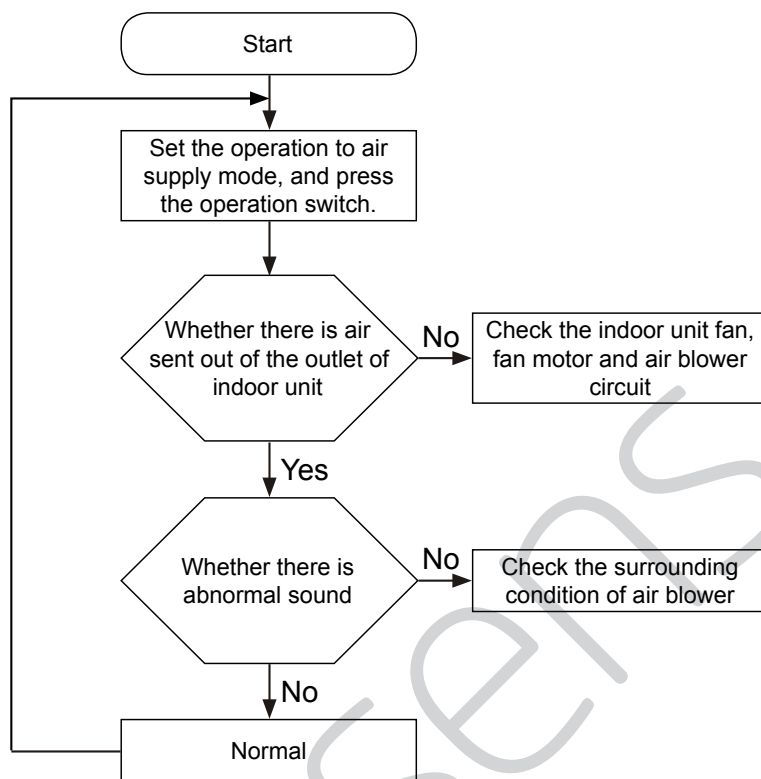

Note: Check the indoor units one by one.

C. Cooling operation confirmation

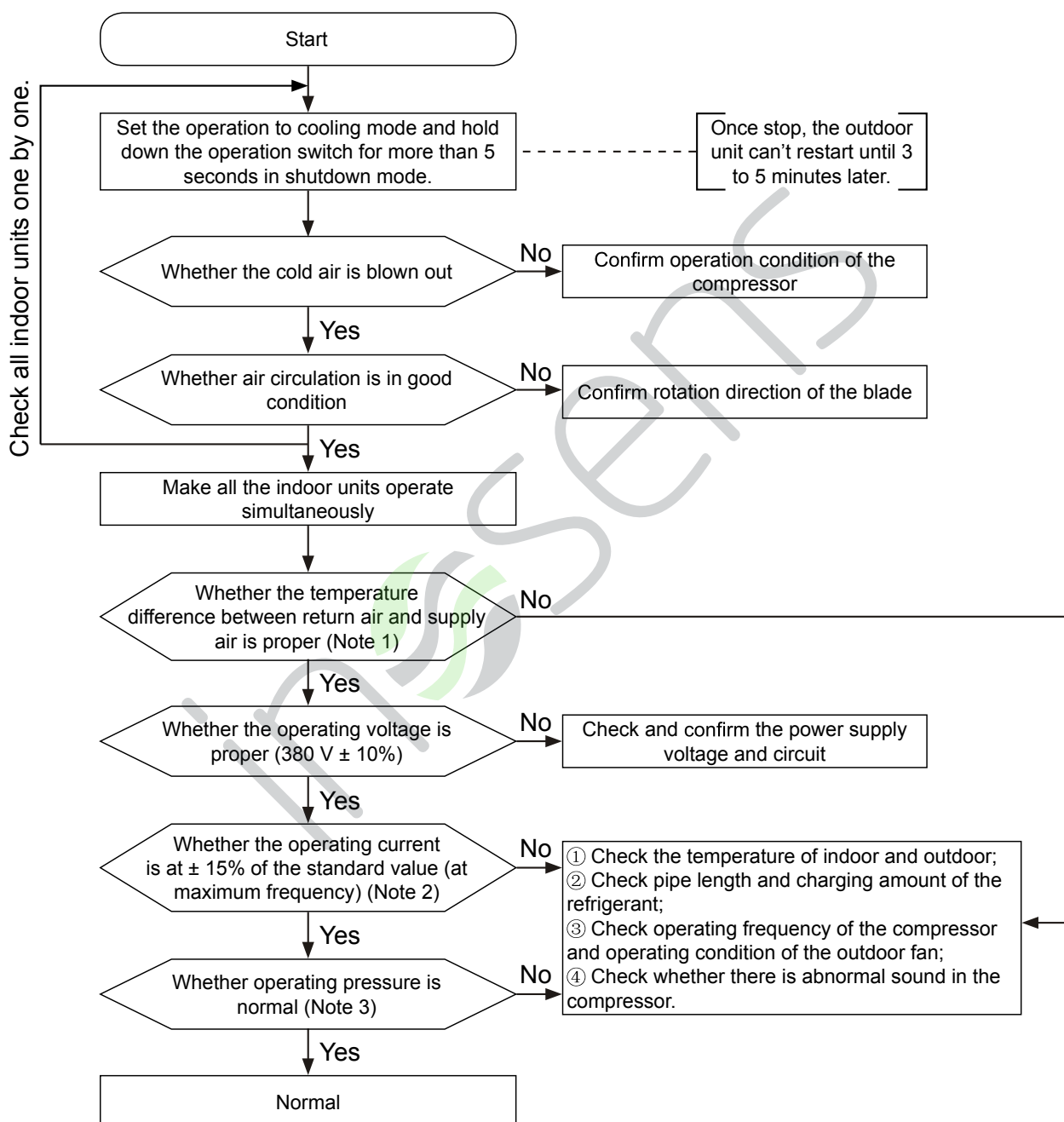

D. Heating operation confirmation

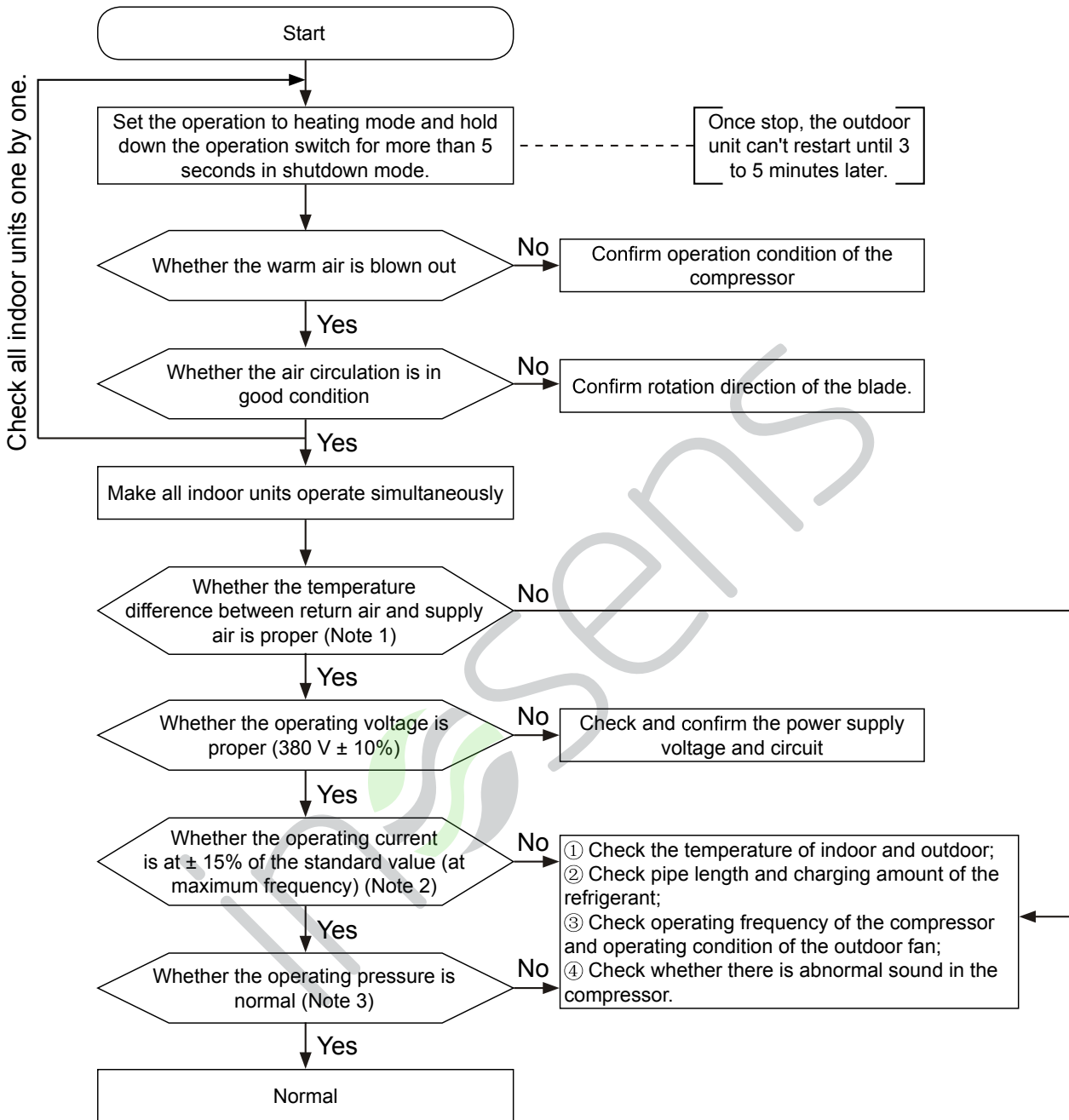

(Note 1) The general standard for temperature difference between inlet and outlet air

In "cooling" operation, it is normal that the dry bulb temperature difference between inlet air and outlet air of the air conditioner is over 10°C (at the maximum frequency) after 30 minutes at least.

In "heating" operation, it is normal that the dry bulb temperature difference between inlet air and outlet air of the air conditioner is over 14°C (at the maximum frequency) after 30 minutes at least.

(Note 2) General standard for operating current

It is normal that the current in either cooling/heating operation mode is within ±15% of the calibrated current. The value of current may have the following differences due to different operation conditions: When higher than the standard value of the current: the temperature of indoor and outdoor is high; heat dissipation of outdoor unit is poor. When lower than the standard value of the current: the temperature of indoor and outdoor is low; refrigerant gas leaks (insufficient refrigerant).

(Note 3) General standard for operating pressure

Cooling (at the maximum frequency)	High pressure 2.0~3.8 MPa	Indoor 18-32°C Outdoor 25-35°C
	Low pressure 0.6~1.0 MPa	
Heating (at the maximum frequency)	High pressure 2.2~3.0 MPa	Indoor 15-25°C Outdoor 5-10°C
	Low pressure 0.3~0.8 MPa	

Values after 15-minute operation (the temperature therein refers to dry bulb temperature with unit of °C)

The transformation trend of high pressure and low pressure due to change of operation condition

Refrigeration/heating: indoor temperature rises – high/low pressure rises

Indoor temperature drops – high/low pressure drops

Outdoor temperature rises – high/low pressure rises

Outdoor temperature drops – high/low pressure drops

Evaluating unit through test device

Operation	Begin to operate the system whose complete setting has been confirmed. Operating methods:	
	1. Switch the BM1, BM2 to OFF , search the indoor units and outdoor unit to check if the number of indoor units are right. 2. Switch the SW1, SW2, SW3 to 0, 13, 2 respectively, then press SW2 for 2 seconds, the digital display tube will display "1111" and indoor unit will enter into cooling operation; or switch SW1, SW2, SW3 to 0, 14, 2 respectively, then press SW2 for 2 seconds, the digital display tube will display "1111", indoor unit will turn on automatically and enter into heating operation. Frequency of compressor is controlled by low pressure control for cooling, and high pressure control for heating.	

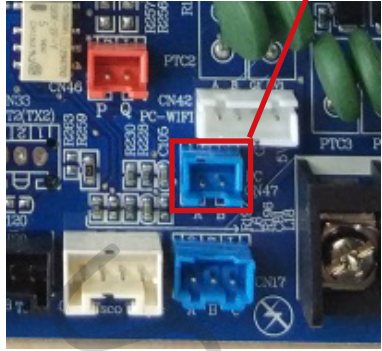
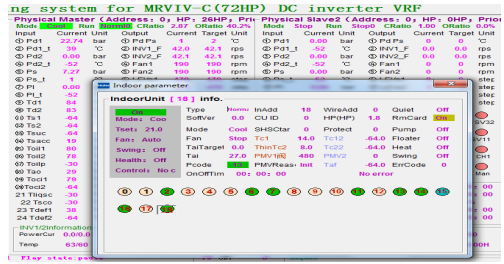
<p>Data measuring</p>	<p>1. Connecting methods of device: Insert one end of data line into the terminal of main PCB CN31 with a two-core terminal, one end connects with 485 device or Gangda device, the other end of the device connects computer.</p>	<p>Position of inserting test device (CN47)</p> 
	<p>2. The data that can acquire through device Outdoor unit: The frequency of outdoor unit compressor /Outdoor fan speed/Opening of outdoor electronic expansion valve/ High pressure of outdoor unit/Corresponding saturation temperature of outdoor unit's high pressure/Low pressure of outdoor unit/Corresponding saturation temperature of outdoor unit's low pressure/Discharging temperature/ Suction temperature/Oil temperature/ Temperature of condenser outlet pipe/Ambient temperature/Temperature of defrosting sensor/Starting of all kinds of solenoid valve Indoor unit: Temperatures of gas pipe and liquid pipe, opening angle of electronic expansion valve /Display of failure</p>	
	<p>3. Test device can display failures of the unit during operation, moreover it can realize a function of storing data in real time, and the test data can be stored in computer.</p>	
	<p>4. Prepare a report according to the test data and submit it to user.</p>	
<p>Confirmation of the data</p>	<p>The confirmation of running data/Timing and recording of the measurement. After the measurement is begun, check the system pressure through detection software. Generally, the cooling low pressure is about 7.5kg and the heating high pressure is about 28kg under rated cooling and heating modes. Then observe if operation under each parameter is normal.</p>	<p>It is normal if there is high pressure frequency limitation or high discharging temperature frequency limitation when outdoor ambient temperature is high and all the indoor units are operating.</p> 
	<p>There is a picture about cooling operating parameters' data in the right column, after operating about half hour, the unit remains stable.</p>	
	<p>Check if there is a blockage in capillary during operation, if any, replace it.</p>	
	<p>Check if there is contact between refrigerant piping and capillary tube, if any, deal with it.</p>	
	<p>Check if wires of sensor (such as wiring, pressure sensor, etc.) are too tight, or contact with vibrating pipe, if so, deal with it.</p>	
	<p>Check if the value of sensor is correct.</p>	

18. Startup

18.1 Startup procedure

1. The materials preparation before on-site commissioning
 - Printed drawing of architectural design
 - Printed installation checking list and system start request
 - Startup manual
 - MRV 5 service manual
 - Trouble shooting and error code
2. Read the attention carefully before start up
3. Installation checking
 - installation checking
 - Parameter standard checking list
4. Operation
 - Dip switch setting for indoor units
 - Dip switch setting for outdoor units
 - Dip switch setting for controllers
 - Power on
 - Locking quantity of indoor and outdoor units (BM1-1/BM1-2)
5. Trail operation
 - Startup of indoor units
 - Running parameter checking
 - Running parameter standard
 - Completion of startup report

18.2 Installation checking

1. Piping
 - Enough fixed supports
 - Branch pipe installed horizontal way
 - Welding (Nitrogen flow)
 - Branch pipe distance, 1m (39.37 inch) away from each other and 0.5m (19.7 inch) far from IDU
2. Drain
 - 1% gradient (indoor unit)
 - Exhaust outlet for drain pipe (indoor unit)
 - Aerial part height above 200mm (outdoor unit)
3. Communication wire (important)
 - PQ cable connected hand by hand
 - The PQ shielded layer must be single point ground to master unit
 - The PQ cable is 2X0.75mm with shielded layer
 - There is at least 10cm (3.94 inch) distance between communication and power source line
 - Before starting, don't connect the terminal PQ to the ODU, it may cause unexpected start
4. Electricity wire
 - Independent wire line to each IDU
 - Same phase power supply
 - Add breaker for each IDU
 - Electricity wire installed to IDU and ODU correctly

5. Indoor unit

- Anti-dust protection during installation
- Installed on properly level
- Service space reserved at least 50X50cm

6. Outdoor unit

- Installed an anti-vibration at the bottom
- Space (20cm/7.87inch away from each other)
- Gather pipe are the same level
- Breaker
- Communication cable (A / B / C, PQ)

7. Pre start up

- 100% of the piping completed the pressure test
- Vacuum test
- The system have been with electric power more than 6h
- Outdoor unit addressing (Master 0, slave 1, slave2)
- Indoor units are addressing correctly
- All the indoor units work correctly in Fan mode

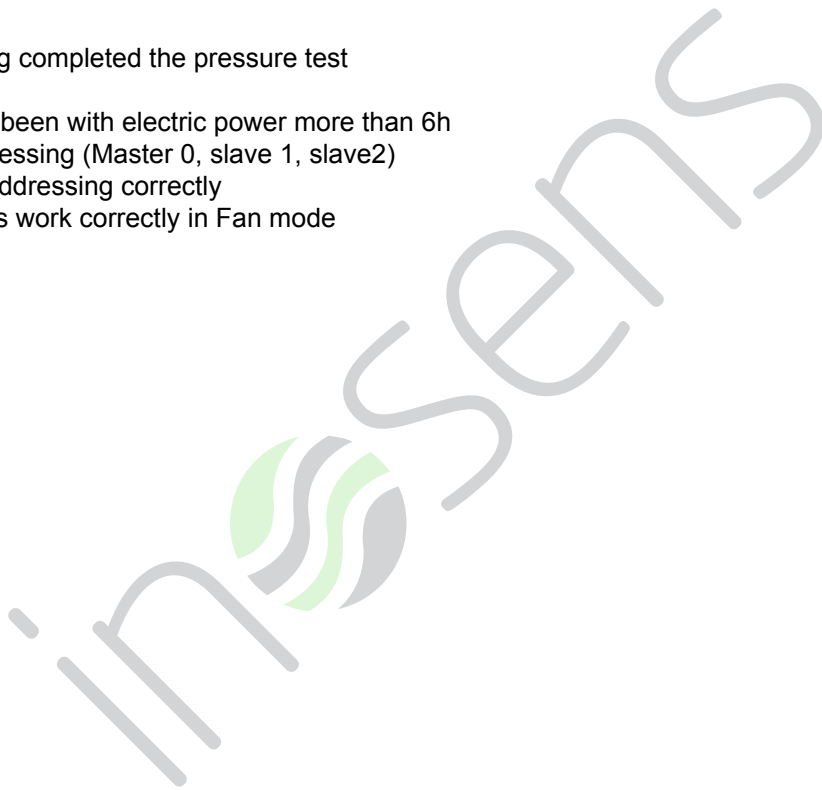

18.3 Wiring-dip switch

1. Indoor dip switch setting—Indoor units for MRV5 and indoor units for MRV IV-C are the same, so indoor dip switch setting is completely the same, please check with the service manual.
2. Controller dip switch setting- it's the same as the controller dip switch setting of MRVIV, please check the service manual.

IDU Dip switch setting

For different IDU PCB board, the setting is little different. When start up, check the below Dip switch setting:

SW01 (1~4 or 2~4)-----Set the master/slave unit when use wired controller in group control

SW01 (5~8)-----Set the capacity of the unit(default setting, no need to reset)

SW03 (1~8)-----Set the communication address and central address(the default setting is set the address by wired controller or automatically)

ODU Dip switch setting

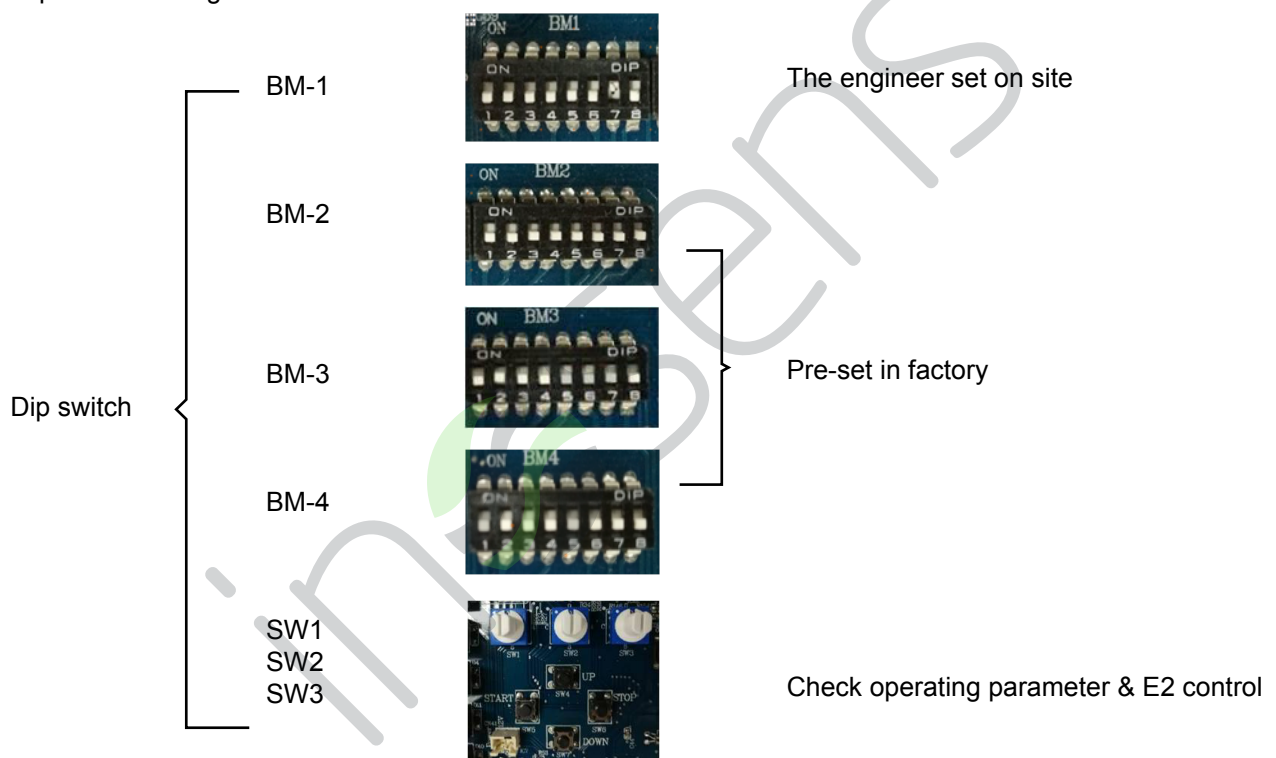

18.4 Power on

1. For the protection of the compressor, It is required to preheat the compressor oil before start up the indoor and outdoor units. 6 hours of preheating is the standard time for the preheating, the engineers have to wait for 6 hours until the compressor oil reaches the required temp. The main PCB will show on the LED time counting down.
2. The outdoor and indoor units communication P, Q should be disconnected before turning on indoor units in case of any unexpected operation.

18.5 Search and lock outdoor \ indoor unit

1. Search: Set BM1-1 at off to search outdoor unit, set BM1-2 at off to search indoor unit.
2. Lock: When ensuring that the displayed indoor units, valve boxes and outdoor units quantity is equal to that of actually installed, the indoor, valve box and outdoor units quantity can be locked. The locking method is to set the master module dip switch BM1-1 and BM1-2 from OFF to ON.

18.6 Trial operation and parameters record

1. The requirement of startup is to set the temp. to be 16 degree centigrade, high speed fan in cooling mode and 30 degree centigrade, high speed fan in heating mode. The following is the example when using wired controller of temp. display.
2. In cooling or in heating mode, let the outdoor and indoor units run for 1 hour;
3. Record for the first time after the unit running for 1 hour, and then record every half an hour for 5 times.
4. Running Parameters Checking Standard.

Mode	TA	Pd(MPa)	Ps(MPa)	Toil	Td(°C)	Ts	Outdoor EEV	Indoor EEV
Cooling	18~27	1.5~2.4	0.4~0.85	closed to Td	60~110	-20~30°C	250	60~480
	28~35	1.7~3.2	0.5~0.9	closed to Td	60~110	-20~30°C	250	60~480
	above 35	2.0~2.9	0.7~1.05	closed to Td	60~110	-20~30°C	250	60~480
Heating	below -5	1.6~2.8	0.1~0.4	closed to Td	60~110	-20~30°C	60-350	200~480
	-5~7	1.9~2.8	0.3~0.8	closed to Td	60~110	-20~30°C	60-350	200~480
	above 7	2.2~3.6	0.8~1.05	closed to Td	60~110	-20~30°C	60-350	200~480

18.7 MRV 5 system startup report



	MRV 5-H
--	---------

ENGLISH BETA 1.2

INSTALATION CHECK LIST AND SYSTEM START UP REQUEST

PROJECT: _____
 CUSTOMER: _____
 INSTALLER: _____
 CITY/COUNTRY: _____
 ADDRESS: _____
 CONTACT TEL: _____

DATE: DD / MM / YY

PROJECT CONFIGURATION

SYSTEM 1 CODE		MODEL	
SYSTEM 2 CODE		MODEL	
SYSTEM 3 CODE		MODEL	
SYSTEM 4 CODE		MODEL	
SYSTEM 5 CODE		MODEL	
SYSTEM 6 CODE		MODEL	
SYSTEM 7 CODE		MODEL	
SYSTEM 8 CODE		MODEL	
SYSTEM 9 CODE		MODEL	
SYSTEM 10 CODE		MODEL	
SYSTEM 11 CODE		MODEL	
SYSTEM 12 CODE		MODEL	
SYSTEM 13 CODE		MODEL	
SYSTEM 14 CODE		MODEL	
SYSTEM 15 CODE		MODEL	

COMMENTS:

INSTALLER: _____

SIGNATURE: _____

DATE : _____

INSTALATION CHECK LIST

1. PREINSTALATION

YES

1.1. REFRIGERATION PIPING

- * Refrigerant piping are correctly insulated.
- * Refrigerant piping have enough fixed supports.
- * All welds were made with permanent nitrogen flow, to create an inert atmosphere.
- * All branch pipes are installed in horizontal direction.
- * There are at least the distance of 1m between branch and branch, and 0.5m far from the indoor units.

1.2. DRAIN

- * Drain piping is correctly insulated.
- * Exhaust outlet for drain pipe.
- * A drop of at least 1% is guaranteed (1 cm per linear meter).
- * Drain's piping diameter is according to requirements.
- * Drain piping is separated for unit with drain pump.

1.3. COMMUNICATION WIRE

- * The communication wire is properly installed between outdoor and indoor units - P/Q (Assy. chain).
- * The wire for centralized control is properly installed between A/C and interface (Assy. chain).
- * Sequence of colors in the cord is guaranteed P-P, Q-Q.
- * The wiring is 2 x 15 with shield cord. The shield layer is fixed to ground on one point.
- * There is independent pipeline for communication wire.
- * There is a 10cm distance between communication wire and electricity wire at least.
- * Before starting, do not connect the terminal P, Q on the outdoor unit, it may cause unexpected start.

1.4. ELECTRICITY WIRE

- * There is independent pipeline for electricity wire to each indoor unit.
- * There is a general power supply for all indoor unit.
- * There is same phase power supply for all indoor units in one group under wired controller.
- * Security power off system: Is there a breaker for each outdoor and indoor unit?
- * Electricity wire is installed to indoor and outdoor units correctly.

1.5. INDOOR UNITS

- * During installation indoor units have dustproof protection.
- * All the units are properly leveled, and fixing system allows adjustments when is required.
- * The flare nuts are correctly adjusted and tightened for each indoor unit.
- * Indoor units are in the perfect physical conditions, free of dents or dings.
- * There is at least 50 cm of free space around indoor unit for service and maintenance.

1.6. OUTDOOR UNITS

- * Is Installed an anti-vibration system for the outdoor units.
- * The ground where the outdoor units are must be properly leveled.
- * 1 meter of distance is guaranteed for the outdoor units of walls and others.
- * Outdoor units are in the perfect physical conditions, free of dents or dings.
- * The outdoor units in same system have 20cm distance to each other.
- * Gather pipe are at the same level.
- * Each outdoor unit have a security breaker.
- * A drain pan is required to the Outdoor unit (HEAT MODE).
- * The communication wire is properly done between the outdoor units A, B, C.
- * The communication wire is correctly done for the centralized monitor between master outdoor unit and interface (Assy. chain)
- * The balance oil pipeline is at the same level Without outlets and Piping trap.
- * Outdoor units are supported on anti-vibration system.

2. PRE START UP

- * 100% Of the piping completed the pressure test at 80 psi (5.5 Kg/cm²) during 3 Minutes
- * 100% Of the piping completed the pressure test at 250 psi (17.5 Kg/cm²) during 2 Hours
- * 100% Of the piping completed the pressure test at 590 psi (40.5 Kg/cm²) during 24 Hours
- * Vacuum test, reaching gauge presssure of: (-755mmHg)
- * The system have been with Electric power more than 6 hours before de start up.
- * Indoor units are addressed properly.
- * Outdoor units are addressed according the position Master, Slave 1, Slave 2 y Slave 3.
- * Once the system is connected to electric power, the master outdoor unit display show the indoor units quantity connected.
- * All the Indoor units and vale boxes work correctly in Fan Mode.

Haier						MRV 5-H	
						ENGLISH BETA 1.2	
SYSTEM START UP LIST							
SYSTEM CODE				MODEL			
* Refrigerant recharge calculation							
Liquid pipe size	Multiple factor	Length	Subtotal				
6.35 (1/4")	0.022						
9.52 (3/8")	0.054						
12.7 (1/2")	0.11						
15.88 (3/4")	0.17						
19.05 (5/8")	0.25						
22.22 (7/8")	0.35						
25.4 (1")	0.52						
		Total(Kg)					
Outdoor unit No. Model Serial No.							
Master							
Slave1							
Slave2							

*Please input measured voltage values before start up:							
L1 vs. L2	V	L1 vs. N	V		L1 vs. Ground	V	
L2 vs. L3	V	L2 vs. N	V		L2 vs. Ground	V	
L3 vs. L1	V	L3 vs. N	V		L3 vs. Ground	V	

START UP

* Do measurements with all units switched ON after 1 hour.

No.	Items	SW9/10/11	Master	SW9/10/11	SLAVE 1	SW9/10/11	SLAVE 2
1	Pressure Pd1 (bar)	0/0/1		1/0/1		2/0/1	
3	Pressure Ps (bar)	0/2/1		1/2/1		2/2/1	
4	Temp.Td1 (°C)	0/3/1		1/3/1		2/3/1	
5	Temp.Td2 (°C)	0/4/1		1/4/1		2/4/1	
8	Temp.Tdef1 (°C)	0/5/1		1/5/1		2/5/1	
10	Temp.TA (°C)	0/1/15		1/1/15		2/1/15	
11	Temp.Toil1 (°C)	0/7/1		1/7/1		2/7/1	
12	Temp.Toil2 (°C)	0/8/1		1/8/1		2/8/1	
13	Temp.Toci1 (°C)	0/9/1		1/8/1		2/8/1	
15	Current CT of inverter compressor INV1	0/10/15		1/10/15		2/10/15	
16	Current CT of inverter compressor INV2	0/11/15		1/11/15		2/11/15	
17	Fixed Compress current	0/15/1		1/15/1		2/15/1	
18	Current frequency of inverter compressor INV1	0/5/0		1/5/0		2/5/0	
19	Current frequency of inverter compressor INV2	0/6/0		1/6/0		2/6/0	
20	Outdoor unit QTY	0/2/2					
21	Indoor unit QTY	0/3/2					
22	Running indoor unit QTY	0/4/2					
23	The end						

Indoor unit No.	Model	PMV	TA	TC1	TC2	Serial N°
1						
2						
3						
4						
5						
6						
7						
8						
9						
10						
11						
12						
13						
14						
15						
16						
17						
18						
19						
20						

19. Outdoor control board photo

PCB code: 0151800256C

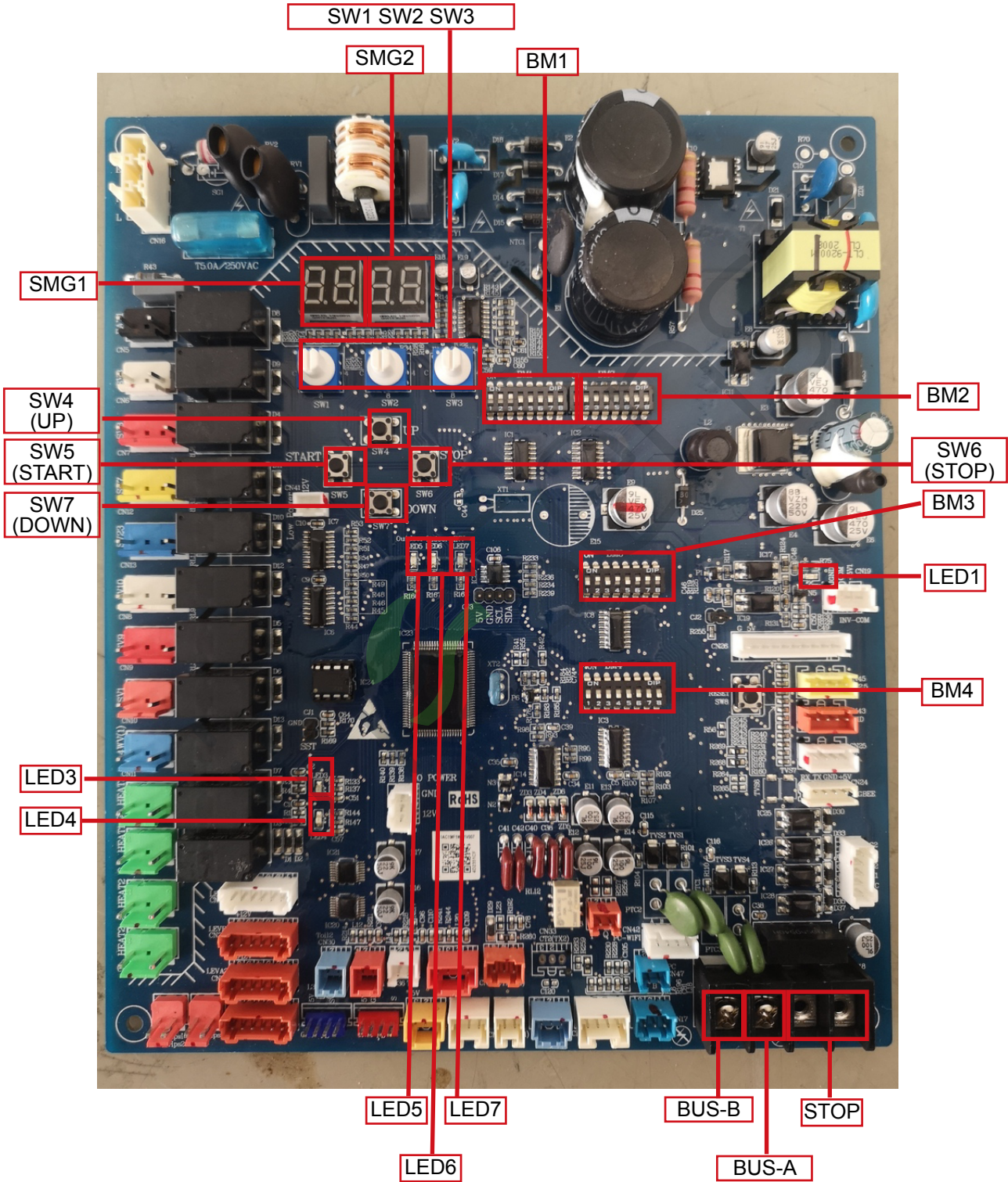

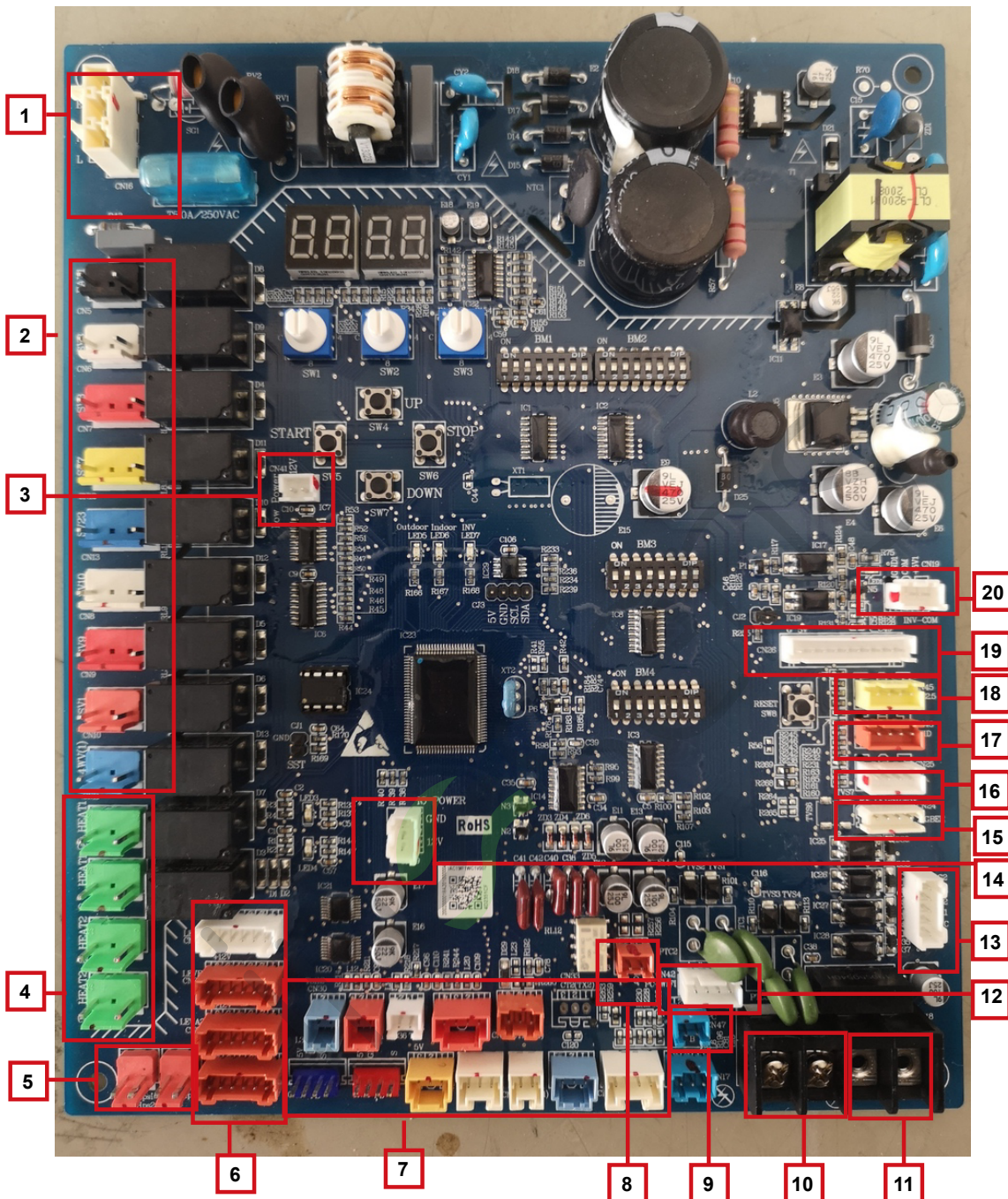

No.	Function	No.	Function
1	Power connector	11	Emergency stop signal connector
2	Solenoid valve connector	12	Monitoring PC WIFI connector
3	Low-power standby control connector	13	Power suppression signal connector
4	Compressor heating tape connector	14	Expansion PCB 12VDC power supply connector
5	High pressure switch connector	15	Zigbee wireless communication connector
6	Outdoor EEV connector	16	Expansion PCB communication connector
7	Ambient temperature, coil temperature sensor	17	Reserved password lock decryption connector
8	Indoor communicating connector	18	Reserved PM2.5 detection connector
9	Monitoring computer connector	19	Programming connector
10	Centralized control 485 communication connector	20	Module board communicating connector

Compressor driver board: 0151800259C

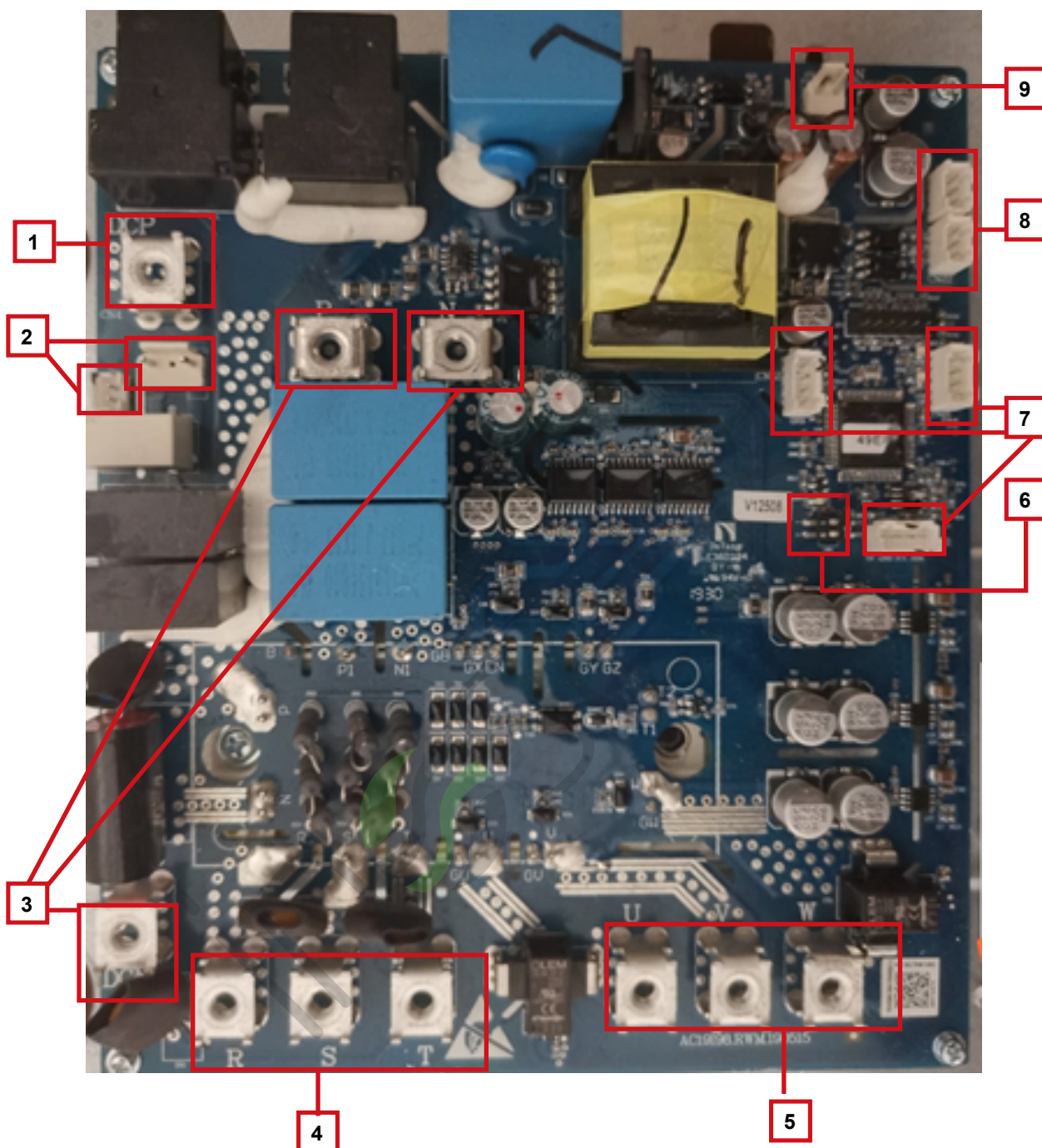

No.	Function
1	Connected reactor connector
2	Low-power standby control connector
3	Connect electrolytic capacitor PCB connector
4	Module three-phase power input connector
5	Module drive output connector
6	Dip switch
7	Programming connector
8	Main PCB and fan motor communicating connector
9	15VDC power output connector

Filter board: 0150401866

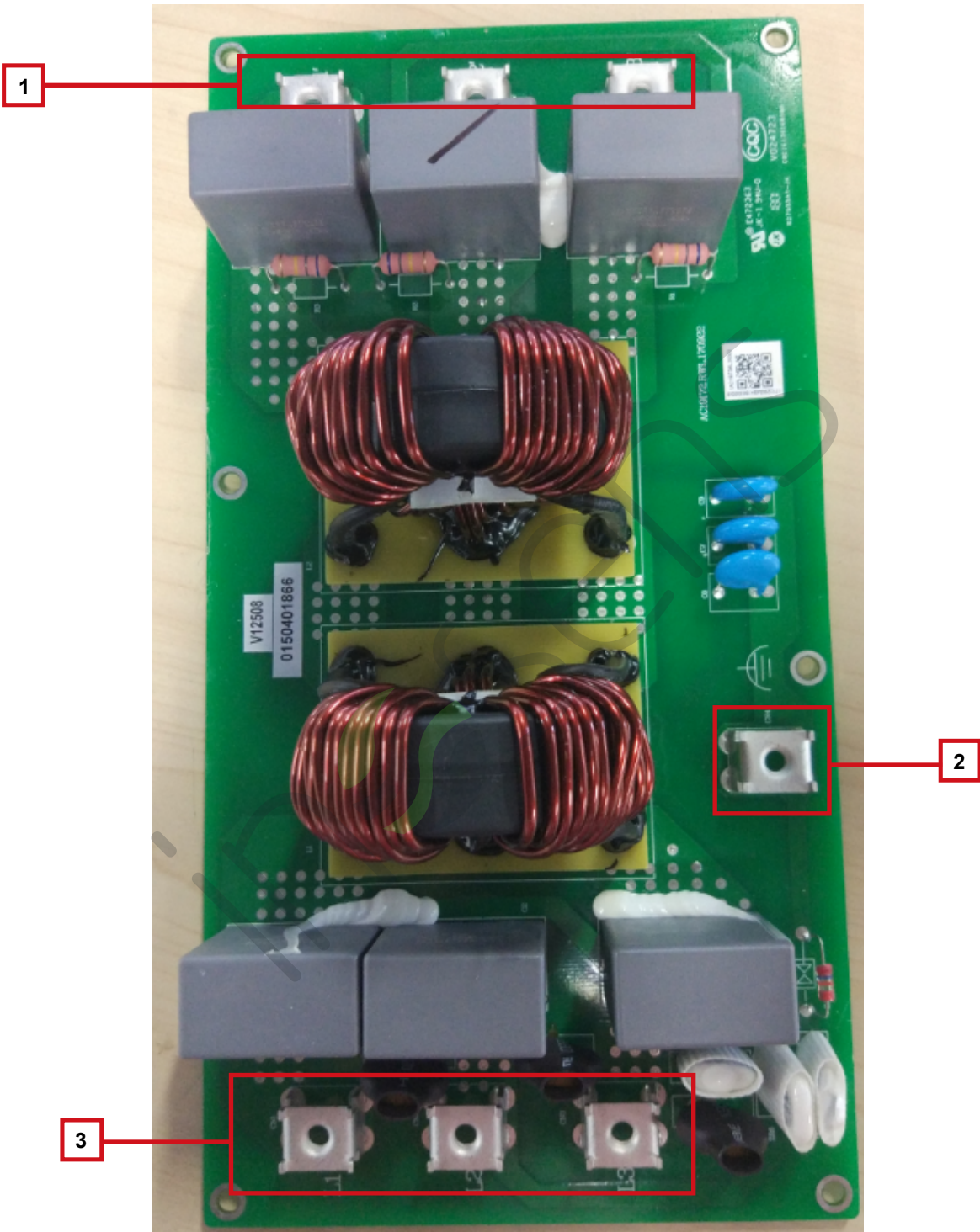

No.	Function
1	Filter board output connector
2	Filter board ground wire connector
3	Filter board power input connector

Capacitor board:0150401863

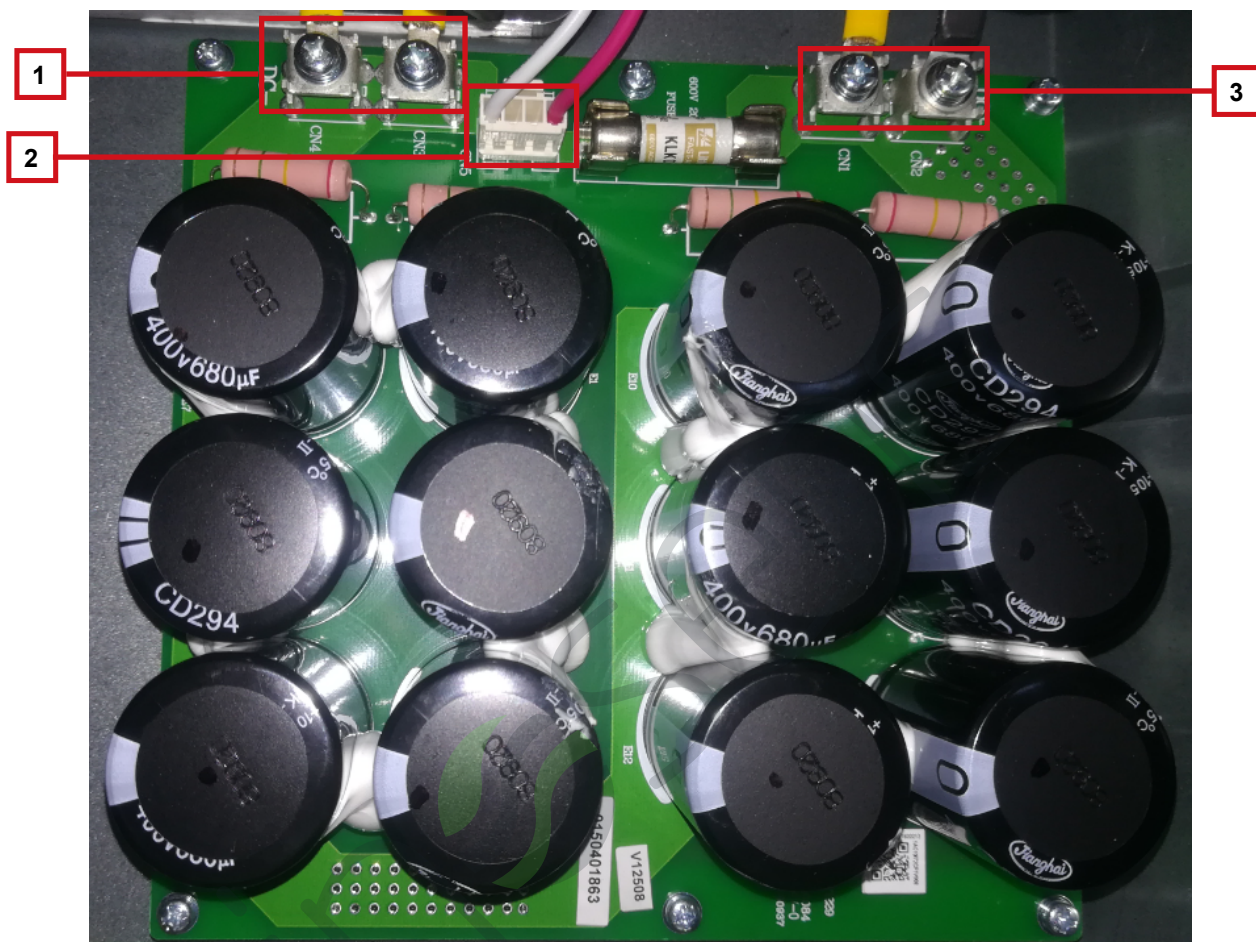

No.	Function
1	Electrolytic capacitor negative connector
2	Fan DC power supply connector
3	Electrolytic capacitor positive connector

20. Outdoor PCB dip switch setting

LED light definition:

- LED1: power supply lamp
Power on light
- LED3: electronic expansion valve LEVa1, LEVa2, fault lamp
No fault, not light
- LED4: electronic expansion valve LEVb, LEVc, fault lamp
No fault, not light
- LED5: communication lamp between outdoors
Communication is normal, flashing
- LED6: communication lamp between indoor and outdoor
Communication is normal, flashing
- LED7: communication lamp between PCB and power module
Communication is normal, flashing

Concept identification:

- Physical master unit: the outdoor unit, whose number is set as 0 by dip switch(BM1-7 and BM1-8), is the communication sponsor and in charge of the communication with indoor unit, also works as initiator of communication of the whole outdoor unit.
- Function master unit: the outdoor unit, whose priority is set as 0, operates with the highest priority.
- Physical slave unit: the outdoor unit, whose number is not set as 0 by dip switch(BM1-7 and BM1-8).
- Function slave unit: the outdoor unit, whose priority is set as 1~3, not operates with the highest priority.
- Setting of group class: the setting of physical master unit is valid for the whole unit.
- Setting of local class: it is only valid for this unit, not for the whole unit.

Dip switch introduction:

- BM1 is usually set by the engineer on site; BM2, BM3, BM4 are pre-set in the factory.
- BM1_1: Master outdoor unit searches the total outdoor units after power on at first time. The quantity of total outdoor units is floating from right to left on digital tube SMG1 and SMG2. "1=0" is one outdoor unit, "2=01" is two outdoor units, "3=012" is three outdoor units, "4=0123" is four outdoor units.
- BM1_2: Master outdoor unit searches the total indoor units after locked the quantity of the outdoor units. The quantity of total indoor units is floating from right to left on digital tube SMG1 and SMG2. "-04-" is 4 indoor units, "-06-" is 6 indoor units, "-15-" is 15 indoor units.
- BM1_3: The setting is OFF or ON. Default is ON. Once power off, unit software shall reset to "OFF" automatically ignoring BM1_3 setting.

① BM1 introduction

BM1_1	Outdoor searching after startup	OFF	Begin to search outdoor		Group class (physical master unit is valid)
		<u>ON</u>	Stop searching outdoor and lock the quantity		
BM1_2	Indoor searching after startup	OFF	Begin to search indoor		
		<u>ON</u>	Stop searching indoor and lock the quantity		
BM1_3	start up after pre-heating for 6 hours	0	Allow(must be electrified for 6 hours)		
		1	Forbidden(can start up immediately)		
BM1_4	Outdoor mode setting	OFF	Heat pump (default)		
		<u>ON</u>	Cooling only		
BM1_5	Outdoor static pressure selection	OFF	No static pressure, high speed (default)		
		<u>ON</u>	Ultra high-speed		
BM1-6	Communication protocol between IDU & ODU	OFF	New protocol (default)		
		<u>ON</u>	Old		
BM1_7 BM1_8	Outdoor address setting	BM1_7	BM1_8	Outdoor address	
		OFF	OFF	0# (physical master unit)	
		OFF	<u>ON</u>	1#	
		<u>ON</u>	OFF	2#	
		<u>ON</u>	<u>ON</u>	3#	

② BM2 introduction

BM2_1 BM2_2	New communication protocol type setting (it is valid when BM1_6 is OFF)	BM2_1	BM2_2	New communication protocol type	Group class (physical master unit is valid)
		OFF	OFF	Wired 9600bps general protocol (default)	
		<u>ON</u>	OFF	Wireless 9600bps communication	
BM2_3	Outdoor heat pump mode setting (it is valid when BM1_4 is OFF)	OFF	Heat pump (default)		
		<u>ON</u>	Heating only		
BM2_4	Outdoor locks the indoor wireless module MAC address (Wireless communication)	Power on, no action	Locked the indoor wireless module MAC address (default)		
		Power on, OFF→ON	Allow all new indoor wireless modules to join (Single-system power-on search mode during debugging)		
BM2_5	Clear the master wireless module EEPROM completely (Wireless communication)	Power on, no action	Normal(default)		
		OFF→ON →OFF	During the debugging process, multiple systems are powered on at the same time, which causes the master wireless module data error, need to do this operation: first setting the digital tube to 1-1-1, then change the dip switch from OFF→ON can clear the master wireless module EEPROM data.		
BM2_6	Billing module selection (Wireless communication)	OFF	No Billing module		
		<u>ON</u>	Billing module		
BM2_7	Quick start selection in high temperature areas	OFF	Forbid quick start (default)		Group class (physical master unit is valid)
		<u>ON</u>	Allow quick start		
BM2_8	Reserved	OFF	Default		

③ BM3 introduction

BM3_1 BM3_2 BM3_3	Outdoor type selection	BM3_1 OFF	BM3_2 ON	BM3_3 OFF	Outdoor MRV5-H outdoor unit	Local class
BM3_4	Reserved	OFF			Default	
BM3_5 BM3_6 BM3_7 BM3_8	Outdoor horse power setting	BM3_5 OFF	BM3_6 OFF	BM3_7 OFF	BM3_8 ON	Outdoor horse 8HP
		OFF	OFF	ON	OFF	10HP
		OFF	OFF	ON	ON	12HP
		OFF	ON	OFF	OFF	14HP
		OFF	ON	OFF	ON	16HP
		OFF	ON	ON	OFF	18HP
		OFF	ON	ON	ON	20HP
		ON	OFF	OFF	OFF	22HP
		ON	OFF	OFF	ON	24HP
		ON	OFF	ON	OFF	26HP

④ BM4 introduction: Group class (physical master unit is valid)

BM4_1 BM4_2	ModBus Central control protocol selection	BM4_1 OFF	BM4_2 OFF	Protocol selection			
		OFF	ON	Third party standard MODBUS protocol (default)			
		ON	OFF	BMS protocol (HCM*)			
		ON	ON	Central control protocol (Y CZ*)			
				Reserved			
BM4_3	Reversed	OFF			Default		
BM4_4 ~ BM4_8	ModBus central control communication address	BM4_4	BM4_5	BM4_6	BM4_7	BM4_8	ModBus set control communication address (IGU02 using the address in bracket)
		OFF	OFF	OFF	OFF	OFF	Address1 (0)
		OFF	OFF	OFF	OFF	ON	Address2 (1)
		OFF	OFF	OFF	ON	OFF	Address3 (2)
		OFF	OFF	OFF	ON	ON	Address4 (3)
		OFF	OFF	ON	OFF	OFF	Address5 (4)
		OFF	OFF	ON	OFF	ON	Address6 (5)
		OFF	OFF	ON	ON	OFF	Address7 (6)
		OFF	OFF	ON	ON	ON	Address8 (7)
		OFF	ON	OFF	OFF	OFF	Address9 (8)
		OFF	ON	OFF	OFF	ON	Address10 (9)
	
		ON	ON	ON	ON	ON	Address32 (31)

Outdoor digital tube display settings

The contents of the display are defined as follows:

- Key parts: long press the left START (SW5) control to enter, short press above UP (SW4) data increase, short press down DOWN (SW7) data reduction, long press the right STOP (SW6) control exit
- Dial: SW1, SW2, SW3: set the turntable dial switch is 0 - 15
- (Note: the dial plate, with the letters A for 10, B for 11, C for 12, D for 13, E for 14, F for 15)
- Display parts: LD1, LD2, LD3, LD4:4 digital tube from left to right

① Indoor unit parameter view

You can view the indoor machine 128 sets of parameters: SW1 and SW2 represent the indoor unit address, SW3 range is 3-14 can view the indoor unit parameters.

SW1	SW2	Address
0	0-15	1 to 16 (address 0#~15#)
1		17 to 32 (address 16#~31#)
2		33 to 48 (address 32#~47#)
3		49to 64 (address 48#~63#)
7		65 to 80 (address 64#~79#)
8		81 to 96 (address 80#~95#)
9		97 to 112(address 96#~111#)
10		113 to 128(address 112~127#)

SW3	Function	Digital tube LD1 ~ 4 display
3	Indoor unit communication check and program version	Communication normal display indoor unit program version (1 decimal), the communication interrupted normal display "0000" (5 consecutive round of no communication success), communication has been abnormal display "---- -"" For example: 3.9, means the indoor unit version is V3.9
4	Indoor unit failure	Display indoor failure code; no failure, display 0
5	Indoor unit capacity	The indoor unit capacity (unit: HP, one decimal), 1.5 HP displays 1.5
6	Indoor EEV open angle	Electronic expansion valve (EEV) open angle (Unit: Pls)
7	Indoor ambient temp. Tai	Ambient temperature (Unit: °C)
8	Indoor gas temperature Tc1	Gas pipe temperature (Unit: °C)
9	Indoor liquid temperature Tc2	Liquid pipe temperature (Unit: °C)
10 (A)	Indoor startup mode, actual fan speed and SCODE code	LED1 shows startup mode (O: Shutdown C: cooling H: Heating) LED2 indicates actual fan speed of indoor unit (0 - stop, 1 - low wind, 2 - medium wind and 3 - high wind) LED3 and LED4 indicate SCODE code (0~15). For example, C311 indicates cooling running at high wind, and the SCODE is 11.
11 (B)	Indoor set temperature Tset	Indoor set temperature (Unit: °C)
12 (C)	Indoor unit consistency control setting	Display the indoor unit group number (0 means unassigned group number, self control) Method of setting group number is same with the <E2 control parameters display and setting> (Note: all the indoor unit' simultaneously setting can be set by a dial 15-0-2. 0- indoor unit self control according to the group number, 1- all indoor unit ON/OFF at the same time 2- indoor unit self control, forbidden control at the same time)
13 (D)	Low temperature automatic running function of indoor unit	Shows whether the indoor unit has this function, 0 - No 1 - Yes Setting method is same with the <E2 control parameters display and setting> (Note: all the indoor unit' simultaneously setting can be set by a dial 15-1-2. Note: all within the machine at the same time setting can be set by dialing 15-1-0- self control, 1- all indoor are valid, 2- all indoor are invalid

SW3	Function	Digital tube LD1 ~ 4 display
14 (E)	Forced indoor cooling / heating / shutdown	(1) press START (SW5) for 2 seconds, to enter setting state, the instruction value is flashing displayed (2) press UP (SW4) or DOWN (SW7) to adjust instruction (COOL/HEAT/OFF). (3) after finish the adjustment, press STOP (SW6) for 2 seconds, execute the setting instruction and stop flashing

② Outdoor unit parameter view

0~3 SW1 is used to select the outdoor machine number, to select the different machine. SW3 range of 0, 1, 15, expressed as the observation of outdoor machine parameters.

(the host can display the parameters of the other outdoor machine and the indoor machine parameters, and the sub machine only displays the machine parameter SW1 is 0).

(1) The first boot, the first sub search engine, from left to right circular display 1:0, if found a table display 2:01 two table display 3:012. "3:012" means a total of 3 units of the system, 012 said the address of the machine. (":" the actual display "=").

(2) Lock machine units, start the search within the machine number, cycle "- in - machine units", such as "-6-" said the system connects the 6 station machine

(3) After the search is completed, the display of the machine's fault code, the machine has no fault when the display 0.

SW1	SW2	SW3	Function	Digital tube LD1 ~ 4 display
Outdoor unit address 0-3	0	0	Display outdoor unit failure code	Failure code transmitted by outdoor bus data. If no failure, display the time as second counting down from the 6 hours for pre-heating. • Press START (SW5) for 2s continuously, display 1111, and access the condition of history fault inquiry to inquire the recent 10 faults: with fault sequence number and fault code displayed by flashing. Press SW4 (UP) once, sequence number will go up 1; press SW7 (DOWN) once, sequence number will decrease 1; 2 min later, quit the setting condition automatically. • Press STOP (SW6) for 2s continuously, display 0000, then quit query status and stop flashing. • When dip switch panel is at 13,0,0, press START (SW5) for 2s continuously, display 1111, thus history fault record can be cleared.
	1	0	Display outdoor unit priority and outdoor unit capacity	LD1: Display priority of outdoor unit LD2: Display "-" LD3-4: Display outdoor unit capacity (unit: HP)
	2	0	Display operation mode and outdoor unit operation output ratio	LD1 shows O: Stop C: Cooling H: Heating LD2 to LD4 show: 60 shows 60% capacity output
	3	0	Outdoor fan 1 speed	345 representation 345rpm • Press START (SW5) for 2s continuously, display 1111, then to set: flashing. Press UP (SW4) once, wind speed will go up 1 level; press DOWN (SW7) once, wind speed will decrease 1 level. 5 min later, quit the setting condition automatically.
	4	0	Outdoor fan 2 speed	• Press STOP (SW6) for 2s continuously, display 0000, then quit the setting condition, and stop flashing.
	5	0	Frequency converter INV1 current frequency	110 representation 110.0Hz Press START (SW5) for 2 seconds, display 1111, enter the set state: flashing display, each according to the 1 UP (SW4) frequency rise 1Hz, every 1 times DOWN (SW7) frequency drop 1Hz; 5min after automatically quit the set state.
6	0	Frequency converter INV2 current frequency	Press STOP (SW6) for 2 seconds, display 0000, quit the set state, stop flashing display; (When the system is faulty, the compressor is forbidden to start.)	

SW1	SW2	SW3	Function	Digital tube LD1 ~ 4 display
Outdoor unit address 0-3	7	0	Outdoor unit LEVa1 open degree	0---470pluse Press START (SW5) for 2 seconds, 1111, enter the setting state: flashing, press UP (SW4) valve fully open, press DOWN (SW7) the valve is fully closed; 2min later automatically exit the setting state Press STOP (SW6) for 2 seconds, display 0000, quit the setting state, stop flashing display
	8	0	Outdoor unit LEVa2 open degree	
	9	0	Outdoor unit LEVb open degree	
	10 (A)	0	Outdoor unit LEVc open degree	
	11 (B)	0	Outdoor unit solenoid valve output	LD1: 4WV : 1 ON 0 OFF LD2: SV1 : 1 ON 0 OFF LD3: SV3: 1 ON 0 OFF LD4: Reserved, Display “-”
	12 (C)	0	Outdoor unit solenoid valve output	LD1: SV6: 1 ON 0 OFF LD2: SV9: 1 ON 0 OFF LD3: SV10: 1 ON 0 OFF LD4: SV11: 1 ON 0 OFF
	13 (D)	0	Outdoor unit solenoid valve output	LD1: SVX: 1 ON 0 OFF LD2: SVY: 1 ON 0 OFF LD3: Reserved, Display “-” LD4: Reserved, Display “-”
	14 (E)	0	Heater output	LD1: CH1: 1 ON 0 OFF LD2: CH2: 1 ON 0 OFF LD3: CHa : 1 ON 0 OFF LD4: Reserved, Display “-”
15 (F)	0	Program version	1 means Ver1.0	

SW1	SW2	SW3	Function	Digital tube LD1 ~ 4 display
Outdoor unit address 0-3	0	1	Pd	Unit: kg, 2 decimal
	2	1	Ps	
	3	1	Td1	
	4	1	Td2	Unit: C
	5	1	Tdef	
	7	1	Toil1	
	8	1	Toil2	
	9	1	Toci1	
	14 (E)	1	Ts	
	15 (F)	1	Th	

SW1	SW2	SW3	Function	Digital tube LD1 ~ 4 display
Outdoor unit address 0-3	1	15 (F)	Tao	Unit: °C
	2	15 (F)	Pd_temp	
	4	15 (F)	Ps_temp	
	5	15 (F)	Tliqsc	
	6	15 (F)	Tsco	
	8	15 (F)	Inverter compressor INV1 ON/OFF time	Unit: Min
	9	15 (F)	Inverter compressor INV2 ON/OFF time	Unit: Min
	10 (A)	15 (F)	Inverter compressor INV1 current CT	Unit: A, 1 decimal
	11 (B)	15 (F)	Inverter compressor INV2 current CT	Unit: A, 1 decimal
	12 (C)	15 (F)	Inverter compressor INV1 DC voltage	Unit: V
	13 (D)	15 (F)	Inverter compressor INV2 DC voltage	Unit: V

SW1	SW2	SW3	Function	Digital tube LD1 ~ 4 display
Outdoor unit address 0-3	14 (E)	15 (F)	Inverter compressor INV1 module temperature	Unit: °C
	15 (F)	15 (F)	Inverter compressor INV2 module temperature	

System status display and control (host)

SW1	SW2	SW3	Function	Digital tube LD1 ~ 4 display
0	0	2	Refrigerant type	410A represents 410A refrigerant
0	1	2	The same outdoor unit total number and total capacity	LD1: The total number of outdoor unit LD2: Display “-” LD3/ LD4: Total outdoor unit capacity (unit: Horse) For example: 3-48 said 3 outdoor machines, with a total capacity of 48 horses
0	2	2	Total indoor unit capacity	50 represents 50 horses
0	3	2	The indoor units within the same system	For example: 64
0	4	2	Number of indoor unit working	Temperature sensor ON as a sign of the work of the indoor unit
0	5	2	With the outdoor unit running mode the same indoor unit number	For example: 13
0	6	2	Cooling target temperature	Unit: degree
0	7	2	Heating target temperature	
0	8	2	Automatic recovery of refrigerant Note: the end of the recovery must be canceled or reset	When the outdoor stops, press START (SW5) for 2 seconds, display 1111, start. (the outdoor is set to work in a state of operation) Press STOP (SW6) for 2 seconds, display 0000, stop
0	10 (A)	2	Test run setup Note: the end of the test run must be canceled or reset	When the outdoor stops, press START (SW5) for 2 seconds, display 1111, start. (the outdoor is set to work in a state of operation) Press STOP (SW6) for 2 seconds, display 0000, stop
0	11 (B)	2	Outdoor unit mode	0-normal C-only cool H-only heat
0	12 (C)	2	Indoor unit expansion valve fully open	Press START (SW5) for 2 seconds, display 1111, indoor valve fully open 2 minutes, 2 minutes after the automatic shutdown valve
0	13 (D)	2	All the indoor unit for cooling	Press START (SW5) for 2 seconds, display 1111, fully open;
0	14 (E)	2	All the indoor unit for heating	Press STOP (SW6) for 2 seconds, 0000, closed
0	15 (F)	2	Cancel all manual control (running class)	Press START (SW5) for 2 seconds, display 1111 cancel; or press STOP (SW6) for 2 seconds, display 0000, cancel Remove all manual control (part), closed indoor unit
0	15 (F)	2	Cancel all manual control (running class)	Press START (SW5) for 2 seconds, display 1111 cancel; or press STOP (SW6) for 2 seconds, display 0000, cancel Remove all manual control (part), all indoor unit close.

E2 control parameters display and setting

Each need to be set, setting method:

(1) Press START (SW5) for 2 seconds, display 1111, enter the set state, flashing display the current value

(2) According to UP (SW4) or DOWN (SW7) adjustment parameters

(3) After the adjustment is completed

<A> In the current state of the code, effectively set the time by pressing STOP (SW6) for 2 seconds, showing 0000, keeping the current settings and exit the set state, stop flashing display, waiting for 2 minutes after the power off and then re power up

 The current set time is not set by STOP (SW6) or change the dial selection, do not save the current set value, exit the set state, stop flashing display

<C> Effective time setting: the machine with the contract number and set off a low temperature automatic operation function for 10 minutes, the other for 30 seconds..

SW1	SW2	SW3	function	Digital tube LD1 ~ 4 display	Control range
15 (F)	0	2	In the same machine drive off control selection	0- machine automatic control according to the group number, all within the machine with 1- drive, 2- all in each machine control, drive off with ban	Group class (physical master unit is valid)
15 (F)	1	2	Selection of low temperature automatic operation control for indoor unit	0- within the machine automatic control, 1- all within the machine is valid, 2- all the inside of the machine is invalid	
15 (F)	2	2	Pipe length selection	0: short pipe length; 1: middle pipe length; 2: long pipe length	
15 (F)	3	2	Defrosting conditions selection	0- normal area, 1- area easy to frost	
15 (F)	4	2	Operation mode priority	0- first open priority; 1- after opening priority 2- cooling priority; 3- heating priority	
15 (F)	5	2	Capacity overmatch selection	0-shows no limitation, 1-shows limitation	
15 (F)	6	2	Heating limit when Outdoor temp Over 25 degree	0-shows no limitation, 1-shows limitation	
15 (F)	7	2	Silent running option	0-without silent operation, 1- silent operation 1, 2- silent operation 2, 3- silent operation 3, 4- silent operation 4	
15 (F)	8	2	snow-proof operation setting	0-without snow-proof operation, 1- without snow-proof operation	
15 (F)	9	2	When the main outdoor machine is running, the choice of the operation of the wind turbine is stopped.	0-stop, 1-run	
15 (F)	12 (C)	2	Power limit operation control mode selection	0- By E2 value, 1- By external contact DRM	
15 (F)	13 (D)	2	Power output ratio selection (E2 control method is valid)	Maximum capacity to allow the maximum number of files, a total of 11 stalls, 0 stalls for 10, 0%, 100%	

SW1	SW2	SW3	Function	Digital tube LD1 ~ 4 display	Control range
15 (F)	1	3	Low consumption mode	0-invalid 1-valid	Group class (physical master unit is valid)
15 (F)	5	3	Heating standby indoor unit forced adjustment valve selection.(except three pipe model)	0-invalid 1-valid	
15 (F)	6	3	Selection of height between indoor units in cooling mode.	0-no drop between indoor units. 1-exist drop between indoor units	

Outdoor unit valve control

SW1	SW2	SW3	Functions	Operation methods
6	15 (F)	2	Cancel all the manual controls (component type)	<ul style="list-style-type: none"> Press START (SW5) for 2s continuously, display 1111, then to quit, or press STOP (SW6) for 2s continuously, display 0000, then quit the set. Cancel items: Movable component control by hand such as compressor, motor, electronic expansion valve (LEV), solenoid valve (SV) and so on (including evacuation and charging; excluding rated operation, compulsory operation, indoor run/stop, etc.)

Examination of local EE data

SW1	SW2	SW3	Function	Display with digital tube LD1~4
12 (C)	0	0	The EE data of address 000H (Version E2)	The first 256 bytes data display of local EE (system parameters information) Calculating address: $addr=SW2 \times 16 + SW3$ Data display: hex display, H means hex number
	0	1	The EE data of address 001H	
	
	0	15 (F)	The EE data of address 00FH	
	1	0	The EE data of address 010H	
	
	1	15 (F)	The EE data of address 01FH	
13 (D)	15 (F)	15 (F)	The EE data of address FFH	The last 256 bytes data display of local EE (Failure information) Calculating address: $addr=SW2 \times 16 + SW3$ Data display: hex display, H means hex number. When the dial-up wheel is on 13 0 0, press START (SW5) for 2 seconds, then the last 256 bytes of EE will be cleared.
	0	0	The EE data of address 100H	
	0	1	The EE data of address 101H	
	
	1	15 (F)	The EE data of address 11FH	
	

Special function (local)

SW1	SW2	SW3	Function	Display with digital tube LD1~4
15 (F)	0	0	Code	MRV 5: 256
	0	1	Outdoor type	MRV 5: 0
	0	3	INV1 module history fault communication data	Long press START key to display INV1/ INV2 module history fault communication data (500 bytes), after display, automatically canceled. Long press STOP key to cancel immediately.
	0	4	INV2 module history fault communication data	
	0	5	BM1 and BM2 setting state	Hexadecimal display, LD1 and LD2 display BM1 LD3 and LD4 display BM2
	0	6	BM3 and BM4 setting state	Hexadecimal display, LD1 and LD2 display BM3 LD3 and LD4 display BM4

21. Outdoor system control function

21.1 Compressor control

Generally, the compressor frequency is controlled according to the target Ps during cooling. During the control process, Pd, Td/TOIL, PS, etc. are given priority.

Generally, the compressor frequency is controlled according to the target Pd during heating. During the control process, Pd, Td/TOIL, PS, etc. are given priority.

Single and double compressor switching based on system load and compressor frequency during dual compressor operation

21.2 Electronic expansion valve control

Cooling: when startup, the electronic expansion valve is maintained at 100 pls and the electronic expansion valve is fully open after startup.

Heating: When heating, the electronic expansion valve is usually superheated to 4 degrees. $SH = T_{oci1} - ET = 4$ (°C)

21.3 Fan motor control

① Control of MRV 5-H series DC motor

The air supply speed of outdoor unit can be set from speed 0 to 22 in accordance with the operating mode.

The operating is commonly at speed 1 - 22, and it is CVT (Continuously Variable Transmission) control between speed 1 and 22.

② Air supply motor: range of number and rotating speed (unit: rpm)

< Outdoor fan motor control (usually control / high static pressure control) >

Level	Double fan	Single fan
24 (high static pressure)	1100+1100	1000
22	1020+1020	1000
21	1000+1000	940
20	970+970	920
19	910+910	880
18	860+860	845
17	800+800	820
16	770+770	760
15	650+650	710
14	560+560	680
13	520+520	640
12	460+460	610
11	410+410	560
10	360+360	520
9	330+330	475
8	300+300	440
7	280+280	415
6	210+210	370
5	190+190	320
4	280	280
3	230	230
2	200	200
1	160	160
0	0	0

The highest speed for each model under normal running condition

Single fan					
Horse power	8	10	12	14	16
Speed	0~16	0~16	0~17	0~19	0~19
Double fan					
Horse power	18	20	22	24	26
Speed	0~19	0~20	0~21	0~22	0~22

a. In cooling mode

Startup procedure: When compressor starts up, if $T_a \geq 35^\circ\text{C}$, the outdoor motor will run at the highest class; if $25^\circ\text{C} \leq T_a < 35^\circ\text{C}$, the outdoor motor will run at the 15 class; if $15^\circ\text{C} \leq T_a < 25^\circ\text{C}$, the outdoor motor will run at the 6 class, if $T_a < 15^\circ\text{C}$, the outdoor motor off, the outdoor motor will run automatically after 45 seconds.

In operation, the motor control by the high pressure. If $P_d < 15\text{kg}$, the motor will run at 1 class, off after 1min; if $15\text{kg} \leq P_d < 20\text{kg}$, the motor will reduce 1 class every 20 seconds, until the lowest class; if $20\text{kg} \leq P_d < 25\text{kg}$, the motor run at the current speed, if $25\text{kg} \leq P_d < 32\text{kg}$, the motor will raise 1 class every 20 seconds, if $P_d \geq 32\text{kg}$, the motor will run at the highest class immediately.

b. In heating mode

When compressor starts up, if $T_a < 10^\circ\text{C}$, the outdoor motor will run at the highest class; if $10^\circ\text{C} \leq T_a < 20^\circ\text{C}$, the outdoor motor will run at the 5 class; if $T_a \geq 20^\circ\text{C}$, the outdoor motor will run at the 1 class; the outdoor motor will run automatically after 60 seconds.

In operation, the motor control by the high pressure. If $P_d > 37\text{kg}$, the motor will be off immediately; if $33\text{kg} < P_d \leq 37\text{kg}$, the motor will reduce 1 class every 20 seconds; if $28\text{kg} < P_d \leq 33\text{kg}$, the motor run at the current speed, if $24\text{kg} < P_d \leq 28\text{kg}$, the motor will raise 1 class every 20 seconds, if $P_d \leq 24\text{kg}$, the motor will run at the highest class immediately.

21.4 Start Control

① Evaluate if the compressor is started according to the superheat of oil temperature or the heating time of energized heating trip, in order to prevent prolonged suspension compressor oil from being severely diluted by refrigerant. The compressor starting conditions are as follows:

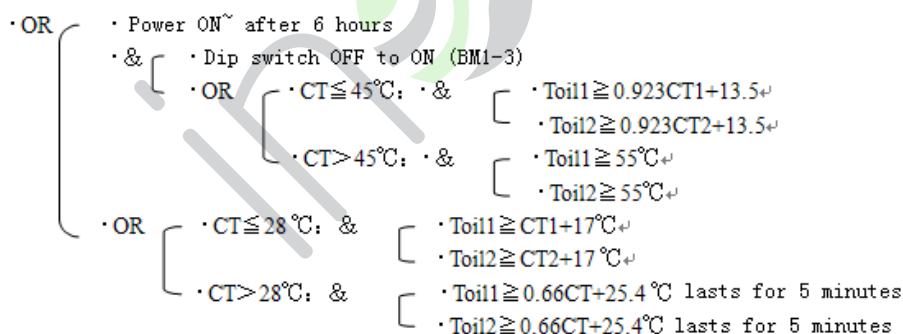

② Compressor start protecting control: Within the 3 min after starting, the operating frequency of compressor keeps at 50rps or 60rps. 3 min later, if $T_d \text{ SH}$ is higher than 25°C , withdrawal from the starting process and conduct target P_d or target P_s control; 3min later, if $T_d \text{ SH}$ is lower than 25°C , the frequency goes up to 100rps and withdrawal from the starting until the $T_d \text{ SH}$ is higher than 25°C or the starting time reaches 15min. In the process of starting, protecting control has the priority.

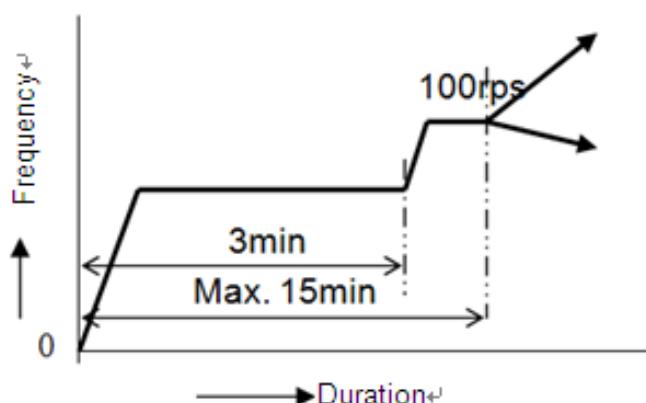

[Note] Frequency maintained within the 3 min after starting is as follows:

- OR
 - $T_{ao} \geq 15^{\circ}\text{C}$: 50rps
 - $T_{ao} < 15^{\circ}\text{C}$: 60rps

③ Restart of the compressor

1. In the control of the compressor, in order to prevent the starting at differential pressure, it must take some time to balance the high and low pressure after stopping fully, the restarting will delay automatically, and the compressor can restart after stopping for 3 to 5 minutes.
2. When the operating mode shifts reversely from [cooling, dehumidifying] to [heating], the all compressors shall stop and delay 3~5 min to restart.
3. When power on, it shall delay 3~5 min to restart the compressor.
4. Before restart the compressor, when the oil temperature cannot meet the start requirement, it will delay the start until oil temperature can meet the requirement.

④ Cycle start function of compressor

1. According to different load of indoor unit, determine the number of compressors needing to start and outdoor units needing to start.
2. If there is only 1 outdoor unit but 2 compressors, shift the priority of compressor 1 and 2 every 4 hours.
3. If there are several outdoor units, the priority of these outdoor units shall be shifted every 8 hours. If the outdoor unit with 2 compressors is operating, it shall shift the priority of compressor 1 and 2 every 4 hours.
4. Shift the priority of compressor and outdoor unit to meet shift interval in the following conditions.
 - 1) When all of compressor and outdoor unit are ON or OFF at the same time, the priority can be shifted directly;
 - 2) When all of outdoor unit and compressor operate in the process of oil return and defrosting, they can shift the priority;
 - 3) When outdoor unit and compressor with higher priority stop upon failure alarm, the priority can be shifted directly without evaluating the interval period.
5. Multi-connected unit of MRV5-H series without fixed host and sub-unit can shift in turn according to the conditions.

⑤ Changes of the number of compressor (take the multiple connection of 3 double compressor of outdoor unit as example)

Compressor shifts its number of operating with the different operating frequency according to the following pictures.

※ No.1 in the following picture represents the compressor with the highest priority, and outdoor unit 1 represents the outdoor unit with the highest priority, and so on.

1. At first, when operating frequency of one compressor of the outdoor unit 1 is less than 75% of the highest frequency, only No. 1 compressor works.

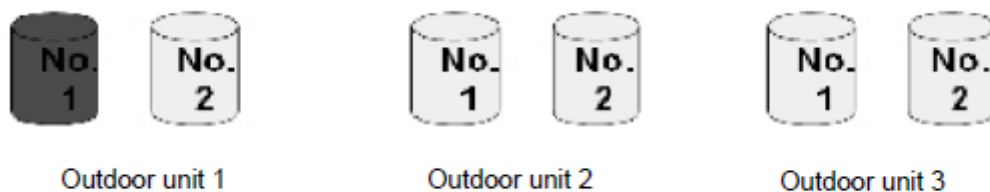

2. When operating frequency of one compressor rises up to the 75% of the highest frequency, two compressors in the outdoor unit 1 will work at the same time.

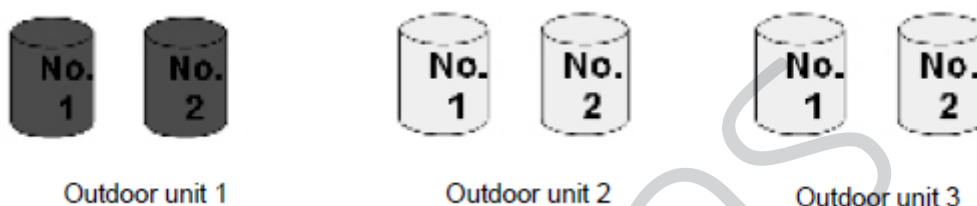

3. When the operation output ratio of the outdoor unit 1 (actual operating frequency/total operating frequency) continue to rise up to the 75%, two compressors in the outdoor unit 2 will also work at the same time.

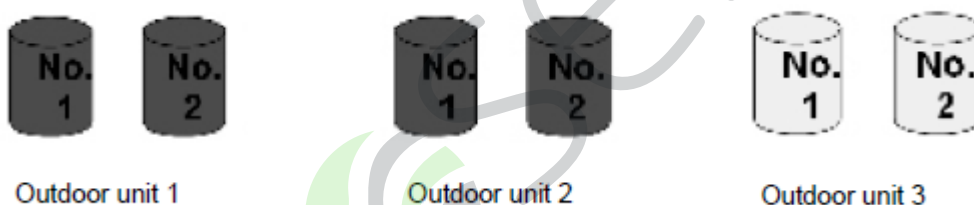

4. When the total operation output ratio of the outdoor unit 1 and outdoor unit 2 (actual operating frequency/total operating frequency) rises up to the 75%, two compressors in the outdoor unit 3 will also work at the same time.

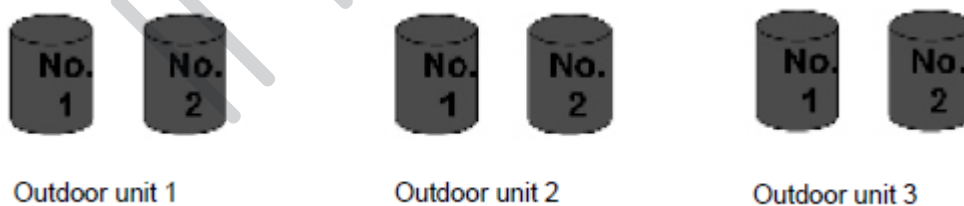

5. When the total operation output ratio of the outdoor unit 1, outdoor unit 2 and outdoor unit 3 declines to the 25%, two compressors in the outdoor unit 3 will stop at the same time, outdoor unit 1 and outdoor unit 2 continue to operate.

6. When the total operation output ratio of the outdoor unit 1 and outdoor unit 2 declines to the 25%, two compressors in the outdoor unit 2 will stop at the same time, and the two compressors in outdoor unit 1 continue to operate.

7. When the total operation output ratio of the outdoor unit 1 declines to the 25%, the No. 2 compressor of outdoor unit 1 will stop and the No. 1 compressor continues to operate.

21.5 Oil return control

1. Entering condition

When outdoor total running capacity is over 25% and less than 75% for 4 hours, or outdoor total running capacity is less than 25% for 2 hours, the system will enter oil return operation.

*When outdoor total running capacity is over 75% for 10 minutes continuously, the oil return time will be cleared.

*In defrosting operation, when outdoor total running capacity is over 75% for 5 minutes continuously, the oil return time will be cleared.

2. Oil return procedure:

All outdoors start up, and run with 75% of total capacity in cooling mode; In oil return course, outdoor lev1, 2 open to 250pls;

In oil return course, THERMO ON, indoor valves 250pls, THERMO OFF, indoor valves 125pls; when Tdi or Toil is over 105°C, indoor valve will open larger 10%.

In oil return, Levb OFF.

Oil return quit condition:

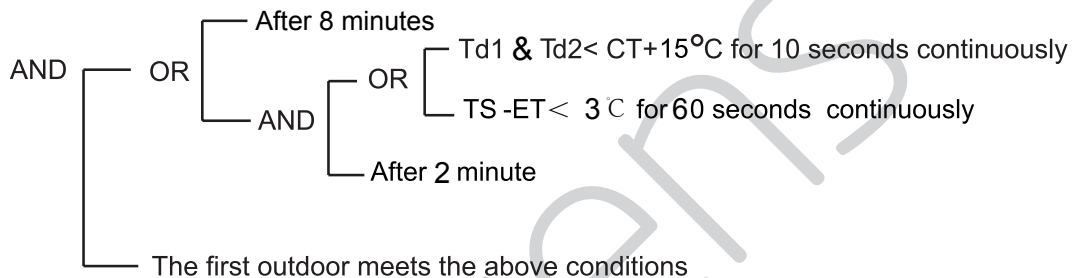

21.6 Defrosting control

Forward defrosting technology, in the case of less frost the MRV 5-H will be forward defrosting, 4-way valve is not reversed. By the using of solenoid valve by-pass defrosting, indoor unit can normal heating, reduce the indoor temperature fluctuations.

Defrost process

- In the case of Little frost and short defrosting time taken, the indoor units will keep running without any change, defrosting is achieved by bypass heating;
- When the frost is small and the defrosting time is long, defrosting is achieved by hot bypass, and the indoor units will enter the anti-cold air mode, and the air speed of the indoor units will be changed from high to mid or low speed.
- When there is a heavy frost , no matter it happens to one condenser or more, whether it is single module or combined module, the 4-way valve of the whole system will change direction together, defrosting will be achieved. Indoor units fans stop running, there is no air out from the indoor units.

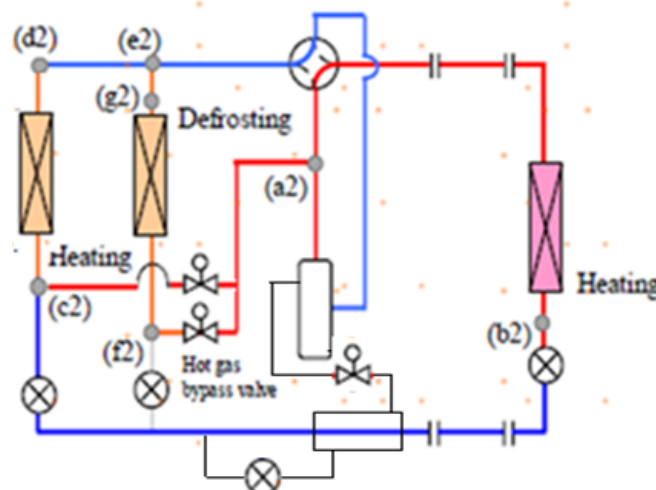

Quit condition:

- OR • After 12 minutes of defrosting operation
- OR —
 - outdoor $T_e \geq 15\text{ }^\circ\text{C}$ lasts 1 minute
 - outdoor $T_e \geq 20\text{ }^\circ\text{C}$ lasts 30 seconds
- OR • $P_d \geq 3.5\text{MPa}$

The program reserves the enhanced defrosting control, to solve the problem of defrosting is not clean, the quit condition is changed to

- OR • After 15 minutes of defrosting operation
- OR —
 - outdoor $T_e \geq 20\text{ }^\circ\text{C}$ lasts 1 minute
 - outdoor $T_e \geq 30\text{ }^\circ\text{C}$ lasts 30 seconds
- OR • $P_d \geq 3.5\text{MPa}$

21.7 Pump down operation

After the liquid refrigerant is retained in the gas-liquid separator, the refrigeration oil in the compressor is diluted to reduce the lubricity, and can cause Liquid compression, which may damage the compressor. This control is to prevent these situations happening.

Pump down operation for cooling

The outdoor unit frequency is 25%* rated frequency, the indoor LEV is fully closed, and other automatic control, after running for a period of time, the exhaust superheat degree meets the requirements and then exits.

Pump down operation for heating

Outdoor unit frequency 25%* rated frequency, outdoor unit LEV fully closed, other automatic control, after running for a period of time, the exhaust superheat degree meets the requirements and then exits

21.8 High pressure protection

In order to maintain normal cooling and heating operation, high pressure control is performed by a high pressure sensor.

Limit the upper limitation of the compressor operating frequency and operating under a certain high pressure value

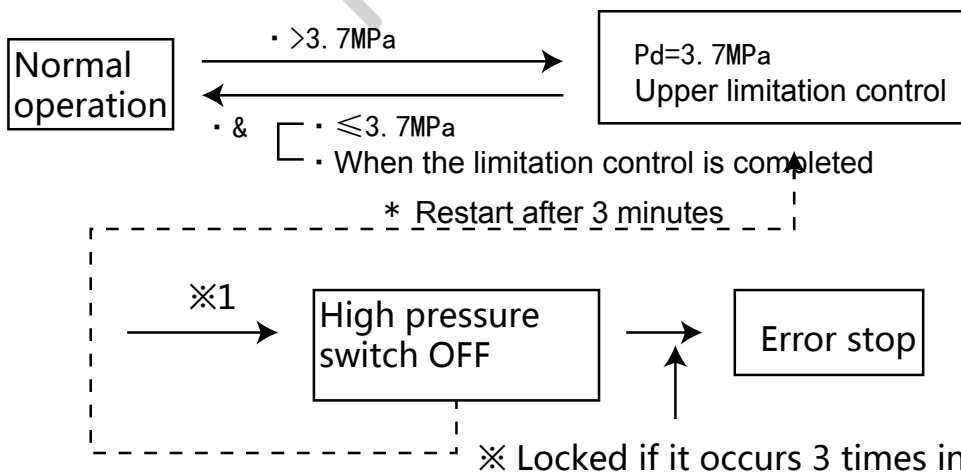

21.9 Low pressure protection

By SV1 and compressor operating frequency control to maintains the low pressure above a specified value.

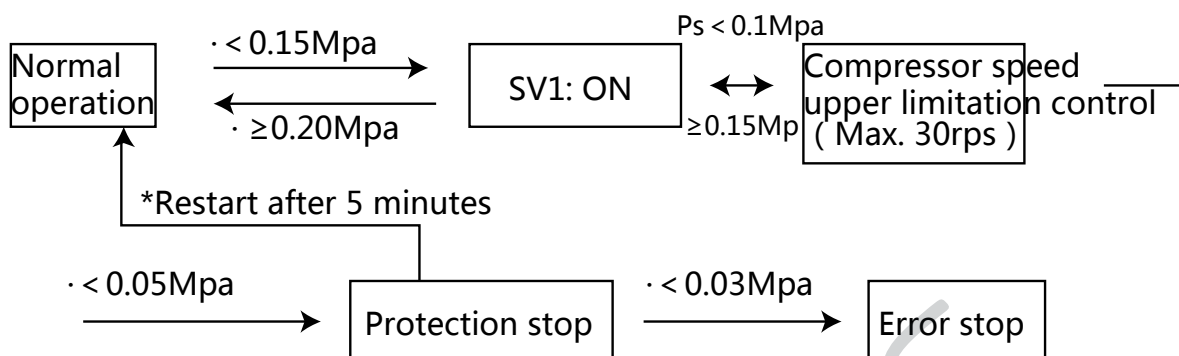

21.10 The temperature of discharge too high control

·Td high temperature side ($\leq 120^{\circ}\text{C}$) is controlled by the “indoor unit SH correction + SV3 LEV/b control + compressor frequency control”. (Note) Compressor frequency control is performed by fuzzy control. .

When the discharge temperature $T_d \geq 95^{\circ}\text{C}$, the SV3 is turned on.

When the discharge temperature $T_d \geq 105^{\circ}\text{C}$, the compressor reduce the frequency

When the discharge temperature $T_d \leq 90^{\circ}\text{C}$, Recovery usually control

21.11. The temperature of discharge too low control

In cooling:

· Td low temperature side ($< CT+10^{\circ}\text{C}$) is controlled by the [the first stage is indoor unit SH control/ the second stage is compressor output control/ the third stage is minimum number of outdoor units running control

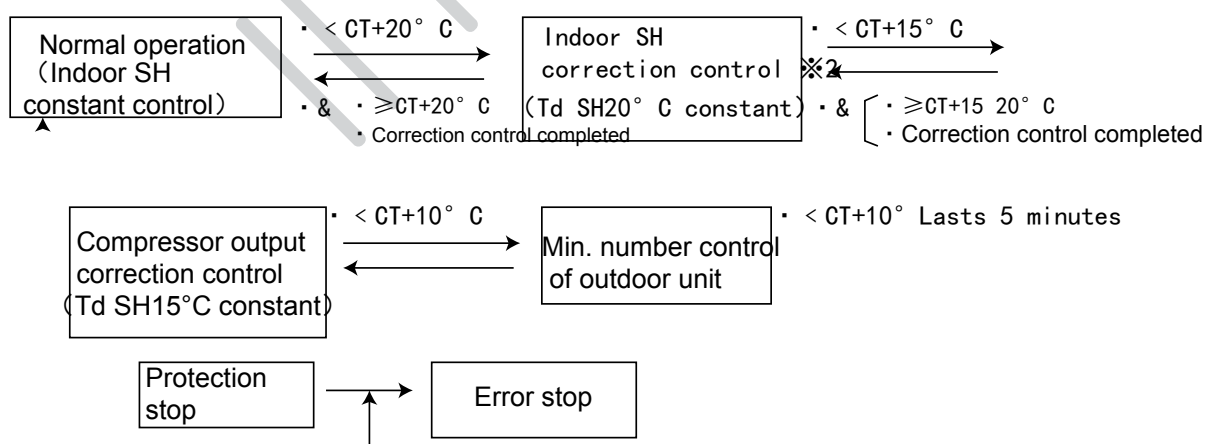

*Restart after 3 minutes

※Locked if it occurs 3 times in an hour

In heating:

- Td low temperature side ($<CT+10^{\circ}C$) is controlled by the [the first stage is indoor unit SH control/ the second stage is compressor output control/ the third stage is minimum number of outdoor units running control]

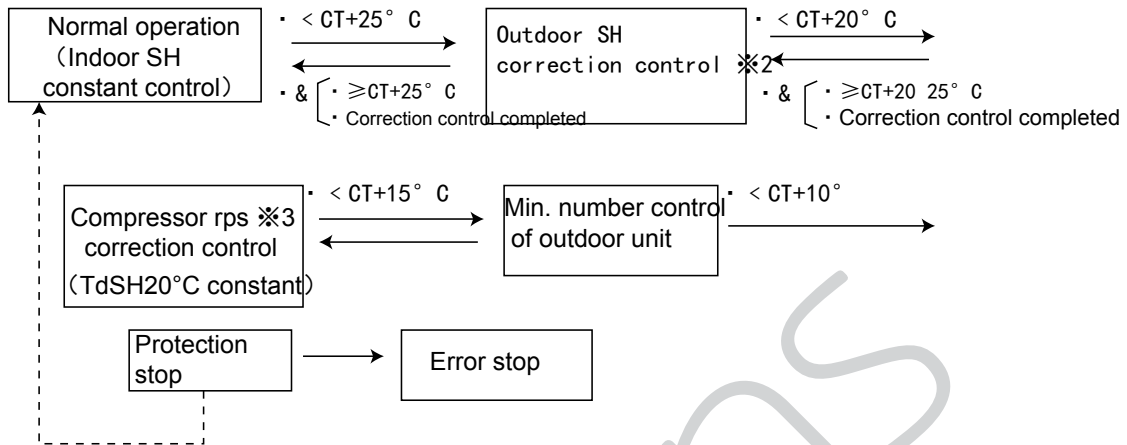

21.12. Radiator protection control

By controlling the frequency of the compressor to control the temperature of the radiator, and the radiator temperature is usually controlled at $95^{\circ}C$. Above $95^{\circ}C$, the outdoor fan increases the speed.

21.13. Anti-snow protection

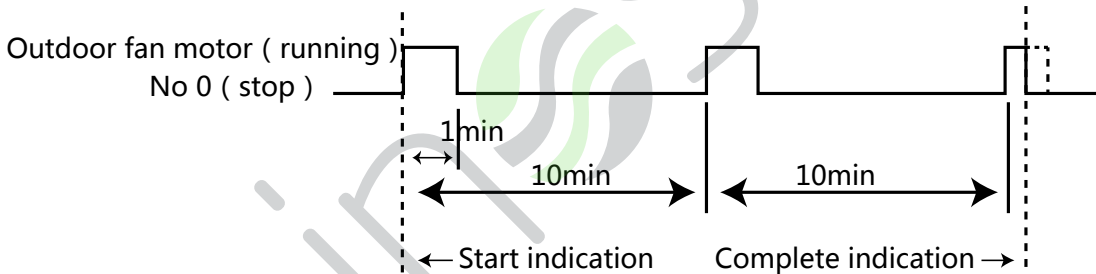

21.14. Heater control

When the system is running, control the heater according to the following picture.

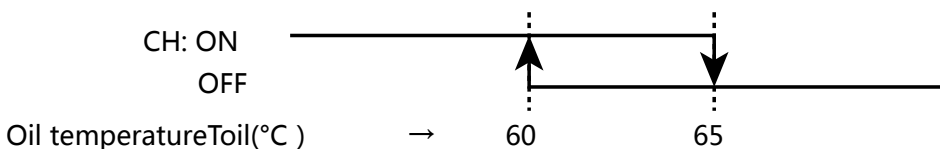

When the compressor oil temperature $Toil$ is $60-65^{\circ}C$, it starts from ON.

CH: Heater (Crank Case Heater)

21.15 Target pressure control

① Cooling low pressure control

Target pressure Ps when cooling		Remarks
Long piping setting	6.5kg	
Medium piping setting	7.5kg	Factory default setting
Short piping setting	8.3kg	

- During cooling, the operating frequency of compressor is fuzzy controlled based on target Ps.
- The frequency of compressor goes down and Ps goes up; the frequency of compressor goes up and Ps goes down.
- During cooling, if the low pressure reaches 1.05MPa, control the LEV of all indoor units to make sure it will not exceed 1.05MPa.

[Note] The one-way connection piping of unit is generally defined as: when the longest piping is less than 30m, it is short piping; 30-90m, medium piping; more than 90m, long piping. The specific situation is determined by installation in site.

② Heating high pressure control

Target pressure Pd when heating		Remarks
Long piping setting	30kg	
Medium piping setting	28kg	Factory default setting
Short piping setting	26kg	

During heating, the operating frequency of compressor is fuzzy controlled based on target Pd. The frequency of compressor goes down and Pd goes down; the frequency of compressor goes up and Pd goes up.

[Note] For heating capacity, if the high pressure is higher, the capacity is higher. However, if the high pressure is higher, the COP of unit will be lower.

21.16 Overheating protection control

① When the temperature at the top of compressor rises, the corresponding SV3 is started to conduct the liquid bypass cooling.

(Refer to Figure) Td high temperature side ($\leq 120^{\circ}\text{C}$) control / SV3 control

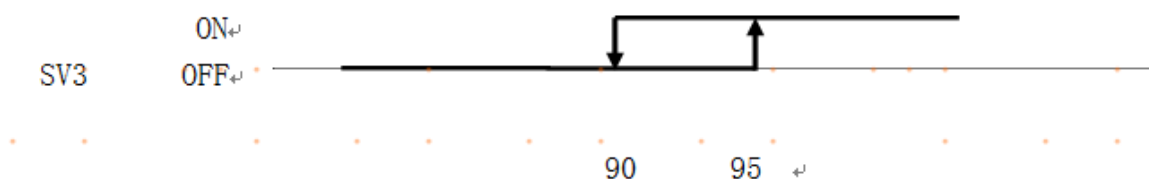

When $T_d \geq 100^{\circ}\text{C}$, in cooling, the indoor unit SH modification control, maximum modification value - 5
 When $T_d \geq 105$, control the compressor frequency

21.17 Current protection control

- ① If the current of compressor exceeds the stipulated upper limit value, the operating frequency is reduced for control before the current changes to exit value or below.
- ② When the current cannot reach the upper limit value or below even at the lowest rotating speed (20rps), the compressor will stop operating.
- ③ If the current reaches the exit value or below, it will get back to the target rotating speed.

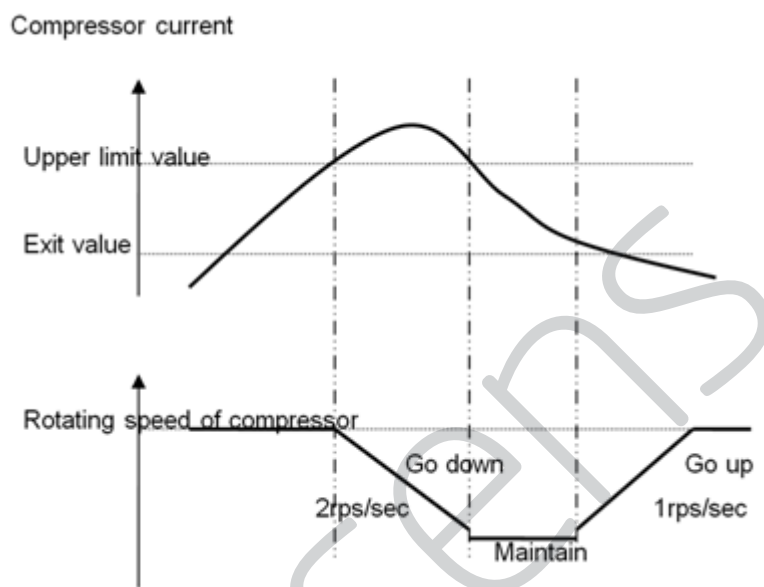

Compressor	ANB42	ANB52	ANB66	ANB78	ANB87
Rated Current	33A	34A	40A	45A	50A

21.18 Heating is prohibited

When the outdoor temperature is greater than or equal to 25 degrees, the setting can be made through the outdoor unit rotary dial, and the outdoor is prohibited from starting.

SW1	SW2	SW3	Function	Digital tube LD1 ~ 4 display
15	6	2	Heating limitation when outdoor temp over 25 degree	0- no limitation, 1-limitation

22. Failure code

Master unit digital tube display	Indication on wired controller (hex)	Failure code definition	Failure description	Remarks
20-0	14	Defrosting temp. sensor Td failure	AD value is below 11(open circuit) or over 1012(short circuit)for 60 seconds,in cooling mode,if the sensor is abnormal,the unit does not deal with it,besides,in defrosting and within 3 minutes after defrosting,no alarm	Resumable
21	15	Ambient temp.sensor Ta failure	AD value is below 11(open circuit) or over 1012(short circuit)for 60 seconds	Resumable
22-2	16	Suction temp.sensor Ts(acc) failure		
23-0	17	Discharging temp. sensor Td1 failure	AD value is below 11(open circuit) or over 1012(short circuit)for 60 seconds	Resumable
23-1	17	Discharging temp. sensor Td2 failure		
24-0	18	Modular heat sensor Th failure	AD value is below 11(open circuit) or over 1012(short circuit)for 60 seconds	Resumable
24-1	18	Oil temp.sensor Toil1 failure	AD value is below 11(open circuit) or over 1012(short circuit)for 60 seconds	
24-2	18	Oil temp.sensor Toil2 failure		
25-0	19	Inlet temp.of heat exchanger Toci1 failure	AD value is below 11(open circuit) or over 1012(short circuit)for 60 seconds	Resumable
26-0	1A	Indoor communication failure	For continuous 200 cycles,can not find connected indoors	Resumable
26-1			For continuous 270 seconds,the searched indoor quantity is less than the set quantity	
26-2			For continuous 170 seconds,the searched indoor quantity is more than the set quantity	
27-0	1B	Oil temp.too high protection (Toil1)	Toil \geq 120℃ continuous 2sec exceeds the set value after shutdown alarm; the alarm condition after stopping the oil temperature below 10 degrees, automatic recovery after 2min50s. Four times an hour to confirm the fault	Once confirmation un-resumable
27-1	1B	Oil temp.too high protection (Toil2)		
28	1C	High pressure sensor Pd failure	AD value is below 11(open circuit)or over 1012(short circuit)for 30 seconds	resumable
29	1D	Low pressure sensor Ps failure	AD value is below 11(open circuit)or over 1012(short circuit)for 30 seconds	

Master unit digital tube display	Indication on wired controller (hex)	Failure code definition	Failure description	Remarks
30-0	1E	High pressure switch HPSi failure	If disconnect for 2s continuously,alarm.If alarm 3 times in an hour,confirm the failure	Once confirmation un-resumable
30-1	1E	High pressure switch HPS2failure		
33-0	21	EEPROM failure	AT24C04 EEPROM communication failure	Once confirmation un-resumable
33-2			AT24C04 EEPROM data check failure(model code,check sun etc)	
33-3			AT24C04 EEPROM data check failure(data beyond limit,reverse sequence etc)	
34-0	22	Discharging temp.too high protection (Td1)	Td \geq 120°C continuous 2sec exceeds the set value after shutdown alarm; the alarm condition after stopping the oil temperature below 10 degrees, automatic recovery after 2min50s. Four times an hour to confirm the fault	Once confirmation un-resumable
34-1	22	Discharging temp.too high protection (Td2)		
35-0	23	4-way valve reversing failure	After 4-way valve is electrified for 10 minutes,if the below conditions can be met for continous 10 seconds,that is conversing successfully. This outdoor compressor is running normally Td1orTd2-Tdef1 \geq 10°C & Toci-Tao \leq 5°C & Pd-Ps \geq 0.3MPa Otherwise, the system alarms reversing failure If it occurs 3 times in an hour,confirm the failure	Once confirmation un-resumable
35-1	23	4-way valve reversing failure	After the start of the main outdoor machine 20min still have a child of the four way valve is not on the electricity is reported 35-1 fault. 2 times an hour to confirm the fault.	Once confirmation un-resumable
36-0	24	Oil temp.too low protection (Toil1)	In normal operation,if Toil < CT+10°C for continuous 5 minntes,the unit stop and alarm.2 minutes and 50 seconds later,resume automatically.If it occurs 3 times in an hour,confirm the failure	Once confirmation un-resumable
36-1	24	Oil temp.too low protection (Toil2)		
39-0	27	Low pressure sensor Ps too low protection	After compressor is running(except for residual operation),if in cooling,Ps < 0.01MPa or in heating, Ps < 0.05MPa for continuous 5 minutes, alarm and stop. 2 minutes and 50 seconds later, resume automatically. If it occurs 3 times in an hour, confirm the failure.	Once confirmation un-resumable
39-1	27	Compression ratio too high Protection	After compressor is running, compression ratio $\epsilon > 10.0$ forcontinuous 5 minutes, stop and alarm. 2 minutess and 50 Seconds later, resume automatically. If it occurs 4 times in an hour, confirm the failure.	
40	28	High pressure sensor Pd too high protection	If Pd \geq 4.15MPa, alarm and stop, 2 minutes and 50 seconds later, resume automatically. If it occurs 3 times in an hour, confirm the failure.	Once confirmation un-resumable

Master unit digital tube display	Indication on wired controller (hex)	Failure code definition	Failure description	Remarks
43-0	2B	Discharging temp.sensor Tdi too low protection	In normal operation,If Td < CT+10℃ for continuous 5 minutes, the unit stops and alarms.2 minutes and 50 seconds later, resume automatically.If it occurs 3 times in an hour,confirm the failure.	Once confirmation un-resumable
43-1	2B	Discharging temp.sensor Td1 too low protection		
45	2D	Communication failure between outdoors	Continuous 30 seconds no communication	resumable
46-0	2E	Communication failure with INV1 module board	Continuous 30 seconds no communication	
46-1		Communication failure with INV2 module board	Continuous 30 seconds no communication	
46-4		Communication with fan 1 module board	Continuous 30 seconds no communication	
46-5		Communication with fan 2 module board	Continuous 30 seconds no communication	
47	2F	Communication failure with wireless module	Wireless module can not detect 2 minutes alarm	
51-0	33	LEVa1 over current protection	LEV drive chip detection	resumable
51-1		LEVa2 over current protection	LEV drive chip detection	resumable
52-0	34	LEVa1 disconnection fault	LEV drive chip detection	resumable
52-1		LEVa2 disconnection fault	LEV drive chip detection	resumable
75-0	4B	High and low pressure difference is too small	Pd-Ps = 0.35Mpa for 3 minutes, if the outdoor protective stop. Protect stop after 5 minutes, then restart	Once confirmation un-resumable
76-0	4C	Incorrect outdoor address or capacity setting	The number of sub machine and host data does not match the EEPROM set	Reset
76-1			The address of sub machine and host data does not match the EEPROM set	
76-2			The capacity setting of sub machine and host data does not match the EEPROM set	
83	53	Incorrect parameter setting or incorrect match of outdoor unit	Outdoor machine type dial code settings error or with the host model does not match	Non recoverable

Master unit digital tube display	Indication on wired controller (hex)	Failure code definition	Failure description	Remarks
99-0	63	The normal running mode is stop\ cooling \ heating, and other modes are abnormal.	System abnormality, chip interference.	Resum-able
99-1		The defrosting and oil return process of the master unit exceeds the normal time	The system is abnormal and does not meet the exit conditions. check the sensor.	
99-2		The defrosting and oil return process of the slave unit exceeds the normal time	The system is abnormal and does not meet the exit conditions. check the sensor.	
99-3	63	The master unit start -up operation process exceeds the normal time	1.the high and low pressure differential of the slave unit does not meet the condition of <0.2MPa 2.check the SV1 and pressure sensor	Resum-able
99-4		The master unit stop operation process exceeds the normal time	The system is abnormal and does not meet the exit conditions. check the sensor.	
99-5		The start-up and stop process of the slave unit exceeds the normal time	1.the high and low pressure differential of the slave unit does not meet the condition of <0.2MPa 2.check the SV1 and pressure sensor	
108	6C	Module rectifier side software transient overcurrent	-	-0: compressor module 1; -1: compressor module 2; -4: fan module 1; -5: fan module 2; (Other faults can be recovered except 110 fault which is locked four times an hour.)
109	6D	Module rectifier side current detection circuit anomaly	-	
110	6E	Module hardware overcurrent	Hardware over current of press drive module.	
			Instantaneous over current of module rectifier side hardware.	
111	6F	Compressor out of step	In the process of starting or running, the rotor position can not be detected for 6 times in a row, and the INV control board is automatically restored after stopping 5S	
112	70	High temperature of module radiator	The temperature more than 94℃ fault alarm. Automatic recovery of INV control board when temperature is 94℃	
113	71	Module overload	-	

Master unit digital tube display	Indication on wired controller (hex)	Failure code definition	Failure description	Remarks
114	72	Module DC bus DC undervoltage	When the supply voltage is less than DC420V, the fault alarm. When the voltage is greater than DC420V, the INV control board is automatically restored	-0: compressor module 1; -1: compressor module 2; -4: fan module 1; -5: fan module 2; (Other faults can be recovered except 110 fault which is locked four times an hour.)
115	73	Module DC bus DC overvoltage	When the supply voltage is greater than DC642V, the fault alarm. When the voltage is less than DC642V, the INV control board is automatically restored.	
116	74	Communication error between module and control board	For 30 seconds, the communication signal is not detected, and the INV control board is recovered immediately after detection	
117	75	Modular software overcurrent	Module rectifier side software instantaneous overcurrent.	
			Module overload.	
			Module software over current.	
118	76	Module boot failure	Compressor 5 consecutive start failure	
119	77	Current detection circuit fault.	The module rectifier side current detection circuit is abnormal.	
			The sensor used for current detection of frequency converter contriller is abnormal,disconnected or incorrectly connected.	
120	78	Module power supply error	Inverter controller power supply instantaneous interrupt	
121	79	Module control board power supply abnormal	Inverter controller board power supply instantaneous interrupt	
122	7A	Module radiator temperature sensor abnormal	Temperature sensor resistance is abnormal or not connected	
123	7B	Module rectifier side hardware transient overcurrent	-	
124	7C	Three phase power supply failure	-	

Master unit digital tube display	Indication on wired controller (hex)	Failure code definition	Failure description	Remarks
125-0/1	7D	Compressor frequency mismatch	(the current frequency is greater than or equal to INV or +3Hz target frequency (frequency) target actual frequency >0 & =0) for 5 minutes	resumable
125-4/5	7D	"Fan speed mismatch (locked rotor)"	Operation below 20rpm lasts for 30s, or less than 20% of the target value lasts for 2 minutes.	resumable
127	7F	MCU reset fault	If the host detects sub machine MCU reset, and the machine is in operation, the host MCU reset the fault, the whole system down; if in the heating mode, then restart the 4WV power, the system re 4WV reversing operation. Four fault confirmation for one hour	resumable

In the case of no fault, if the system does not meet the start-up conditions, the host digital display standby code:

555.0	Indoor machine capacity beyond the outdoor machine capacity of 150% or less than 50%, standby system	Indoor machine capacity beyond the outdoor machine capacity of 150% or less than 50%, standby system	resumable
555.1	26 degree standby	Ambient temperature above 26 degrees indoor heat can not boot	
555.2	Low pressure (gas) standby	Refrigeration Ps<0.23Mpa or heating Ps<0.12Mpa start, system standby	
555.3	54 degrees above the cooling outdoor machine is not running	54 degrees above the cooling outdoor machine is not running	
555.5	Power restriction	Power inhibit setting maximum capacity output is 0%	
555.6	Password lock	Password lock system to set the maximum operating time to the system standby	
555.8	No trial running	No trial running	

※Failure code distribution introduction

0 ~ 19: indoor unit failure

20 ~ 99: outdoor unit failure

108 ~ 125: inverter module failure

126 / 127: soft self-detect

23. Troubleshooting

23.1 Flow chart

Failure code Outdoor digital display tube: 20-0 Indoor wired controller: 14	Indoor unit LED status	LED5		Failure description: Defrosting temperature sensors: Tdef failure
		20 times		
	Outdoor unit LED status Normal	LED1	LED2	
Normal		Normal		
1. Model	Failure diagnosis and troubleshooting			
MRV 5 series	Diagnosis	Troubleshooting		
2. Abnormity detection method	<pre> graph TD A{Check if the corresponding connector of sensor is normal} -- N --> B[Replace it correctly by after-sales personnel on site.] A -- Y --> C{Check if resistance characteristic of the sensor is normal} C -- N --> D[Replace it correctly by after-sales personnel on site.] C -- Y --> E{Check if the temperature loop acquired by the computer board is normal} E -- Y --> F[Replace it correctly by after-sales personnel on site.] </pre>			
3. Abnormity confirmation conditions				
AD value is below 11 (open circuit) or over 1012 (short circuit) for 60 seconds, sensor has no alarm when abnormal in cooling mode.				
4. Possible causes				
<ul style="list-style-type: none"> ◆ The connection of sensor is not secure; ◆ The sensor is broken; ◆ The sensor is with resistance drift; ◆ The temperature acquired by PCB is not accurate. 				

Failure code Outdoor digital display tube: 21 Indoor wired controller: 15	Indoor unit LED status		LED5		Failure description: Ambient temperature sensor: Tao failure
	Outdoor unit LED status		20 times		
			LED1	LED2	
			Normal	Normal	
1. Model	Failure diagnosis and troubleshooting				
MRV 5 series	Diagnosis			Troubleshooting	
2. Abnormity detection method	<pre> graph TD A{Check if the corresponding connector of sensor is normal} -- N --> B[Replace it correctly by after-sales personnel on site.] A -- Y --> C{Check if resistance characteristic of the sensor is normal} C -- N --> D[Replace it correctly by after-sales personnel on site.] C -- Y --> E{Check if the temperature loop acquired by the computer board is normal} E -- Y --> F[Replace it correctly by after-sales personnel on site.] </pre>				
3. Abnormity confirmation conditions					
It is detected that the AD value is below 11 (open circuit) or above 1012 (short circuit) for 60 seconds continuously, and no alarm is given during defrosting and within 3 minutes at the end of defrosting.					
4. Possible causes					
<ul style="list-style-type: none"> ◆ The connection of sensor is not secure; ◆ The sensor is broken; ◆ The sensor is with resistance drift; ◆ The temperature acquired by PCB is not accurate. 					

Failure code Outdoor digital display tube: 22-2 Indoor wired controller: 16	Indoor unit LED status		LED5		Failure description: Suction temperature sensor: Ts failure
	Outdoor unit LED status		20 times		
			LED1	LED2	
			Normal	Normal	
1. Model	Failure diagnosis and troubleshooting				
MRV 5 series	Diagnosis			Troubleshooting	
2. Abnormity detection method	<pre> graph TD A{Check if the corresponding connector of sensor is normal} -- N --> B[Replace it correctly by after-sales personnel on site.] A -- Y --> C{Check if resistance characteristic of the sensor is normal} C -- N --> D[Replace it correctly by after-sales personnel on site.] C -- Y --> E{Check if the temperature loop acquired by the computer board is normal} E -- Y --> F[Replace it correctly by after-sales personnel on site.] </pre>				
3. Abnormity confirmation conditions					
It is detected that the AD value is below 11 (open circuit) or above 1012 (short circuit) for 60 seconds continuously, and no alarm is given during defrosting and within 3 minutes at the end of defrosting.					
4. Possible causes					
<ul style="list-style-type: none"> ◆ The connection of sensor is not secure; ◆ The sensor is broken; ◆ The sensor is with resistance drift; ◆ The temperature acquired by PCB is not accurate. 					

FFailure code Outdoor digital display tube: 23-0,1 Indoor wired controller: 17	Indoor unit LED status	LED5		Failure description: Discharging temperature sensor: Td1 and Td2 failure
		20 times		
	Outdoor unit LED status	LED1	LED2	
Normal		Normal		
1. Model	Failure diagnosis and troubleshooting			
MRV 5 series	Diagnosis	Troubleshooting		
2. Abnormity detection method	<pre> graph TD A{Check if the corresponding connector of sensor is normal} -- N --> B[Replace it correctly by after-sales personnel on site.] A -- Y --> C{Check if resistance characteristic of the sensor is normal} C -- N --> D[Replace it correctly by after-sales personnel on site.] C -- Y --> E{Check if the temperature loop acquired by the computer board is normal} E -- Y --> F[Replace it correctly by after-sales personnel on site.] </pre>			
3. Abnormity confirmation conditions				
It is detected that the AD value is below 11 (open circuit) or above 1012 (short circuit) for 60 seconds continuously. If $T_a \leq -10^\circ\text{C}$ the open circuit is detected after 3 minutes of compressor operation (AD value is below 11).				
4. Possible causes				
<ul style="list-style-type: none"> ◆ The connection of sensor is not secure; ◆ The sensor is broken; ◆ The sensor is with resistance drift; ◆ The temperature acquired by PCB is not accurate. 				

Failure code Outdoor digital display tube: 24-0, 1, 2 Indoor wired controller: 18	Indoor unit LED status		LED5		Failure description: Oil temperature sensor: Th, Toil1 and Toil2 failure
	Outdoor unit LED status		20 times		
			LED1	LED2	
			Normal	Normal	
1. Model	Failure diagnosis and troubleshooting				
MRV 5 series	Diagnosis			Troubleshooting	
2. Abnormity detection method	<pre> graph TD A{Check if the corresponding connector of sensor is normal} -- N --> B[Replace it correctly by after-sales personnel on site.] A -- Y --> C{Check if resistance characteristic of the sensor is normal} C -- N --> D[Replace it correctly by after-sales personnel on site.] C -- Y --> E{Check if the temperature loop acquired by the computer board is normal} E -- Y --> F[Replace it correctly by after-sales personnel on site.] </pre>				
3. Abnormity confirmation conditions					
It is detected that the AD value is below 11 (open circuit) or above 1012 (short circuit) for 60 seconds continuously, when $T_a \leq -10^\circ\text{C}$, no alarm is given; when $T_a \leq -10^\circ\text{C}$, no alarm is given within 5 minutes.					
4. Possible causes					
<ul style="list-style-type: none"> ◆ The connection of sensor is not secure; ◆ The sensor is broken; ◆ The oil temperature sensor is with resistance drift; ◆ The temperature acquired by PCB is not accurate. 					

Failure code Outdoor digital display tube: 25-0 Indoor wired controller: 19	Indoor unit LED status	LED5		Failure description: Heat exchanger inlet temperature: Toci1 failure
		20 times		
	Outdoor unit LED status	LED1	LED2	
		Normal	Normal	

1. Model	Failure diagnosis and troubleshooting	
MRV 5 series	Diagnosis	Troubleshooting
2. Abnormity detection method	<pre> graph TD A{Check if the corresponding connector of sensor is normal} -- N --> B[Replace it correctly by after-sales personnel on site.] A -- Y --> C{Check if resistance characteristic of the sensor is normal} C -- N --> D[Replace it correctly by after-sales personnel on site.] C -- Y --> E{Check if the temperature loop acquired by the computer board is normal} E -- Y --> F[Replace it correctly by after-sales personnel on site.] </pre>	
3. Abnormity confirmation conditions		
It is detected that the AD value is below 11 (open circuit) or above 1012 (short circuit) for 60 seconds continuously, the cooling mode operates the sensor abnormity without troubleshooting it, and no alarm is given during defrosting and within 3 minutes at the end of defrosting.		
4. Possible causes		
<ul style="list-style-type: none"> ◆ The connection of sensor is not secure; ◆ The sensor is broken; ◆ The sensor is with resistance drift; ◆ The temperature acquired by PCB is not accurate. 		

Failure code Outdoor digital display tube: 26-0, 1, 2 Indoor wired controller: 1A	Indoor unit LED status	LED5		Failure description: Communication between indoor unit and outdoor unit failure
		20 times		
	Outdoor unit LED status	LED1	LED2	
		Normal	Normal	

1. Model	Failure diagnosis and troubleshooting		
MRV 5 series	Diagnosis	Troubleshooting	
2. Abnormity detection method	<pre> graph TD A{Check if the communication wire of outdoor unit is shorted} -- Y --> B[Replace it correctly by after-sales personnel on site.] A -- N --> C{Check if the communication wire of outdoor unit is disconnected} C -- Y --> D[Replace it correctly by after-sales personnel on site.] C -- N --> E{Check if the communication wire P and Q of indoor and outdoor unit is incorrect} E -- Y --> F[Replace it correctly by after-sales personnel on site.] E -- N --> G{Check if there is same indoor unit No.} G -- Y --> H[Adjust it correctly by after-sales personnel on site.] G -- N --> I{Check if the computer board communication port of indoor and outdoor unit is correct} I -- N --> J[Adjust it correctly by after-sales personnel on site.] I -- Y --> K{Check if there is interference source} K -- Y --> L[Eliminate the interference source.] K -- N --> M{Replace indoor or outdoor computer board} </pre>		
3. Abnormity confirmation conditions	<ul style="list-style-type: none"> ◆ Grounded short-circuit of communication wire, or disconnected communication wire P and Q; ◆ Incorrect wiring of communication wire P and Q; ◆ Uniform indoor unit power supply, and partial indoor unit being powered off. ◆ Larger interference and unstable communication signal. ◆ Failure in PCB of indoor and outdoor unit results in unstable communication. 		
4. Possible causes	<p>It is not detected that there is indoor unit connection for 200 rounds continuously; it is detected that the number of indoor units is less than set number for 270 seconds continuously; it is detected that the number of indoor units is more than set number for 170 seconds continuously.</p> <ul style="list-style-type: none"> ◆ Poor communication wire: short circuit and disconnection; ◆ Incorrect wiring of communication wire P and Q P and Q; ◆ Poor PCB results poor communication; ◆ Larger interference of normal communication. 		

Failure code Outdoor digital display tube: 27-0, 1 Indoor wired controller: 1B	Indoor unit LED status	LED5		Failure description: Outdoor compressor oil temperature too high failure(Toil1 and Toil2)
		20 times		
	Outdoor unit LED status	LED1	LED2	
Normal		Normal		
1. Model	Failure diagnosis and troubleshooting			
MRV 5 series	Diagnosis		Troubleshooting	
2. Abnormity detection method	<pre> graph TD A{Check if the resistance of oil temperature sensor is correct} -- N --> B[Replace the oil temperature sensor by after-sales personnel on site.] A -- Y --> C{Check if the refrigerant in the system is with leakage or insufficient} C -- Y --> D[Replace it correctly by after-sales personnel on site and ensure refrigerant is enough.] C -- N --> E{Check if the outdoor heat exchange is normal when cooling, and check if the indoor heating is normal when heating} E -- N --> F[Replace it correctly by after-sales personnel on site.] E -- Y --> G{Check if the outdoor unit LEVb, SV31 and SV32 can be turned on normally} G -- N --> H[Troubleshoot and replace it correctly by after-sales personnel on site.] G -- Y --> I{Check if it is beyond the allowed operation range of unit.} I -- Y --> J[Use the unit in accordance with its allowed range.] </pre>			
3. Abnormity confirmation conditions				
Toil1/Toil2≥120°C.				
4. Possible causes				
<ul style="list-style-type: none"> ◆ The oil temperature sensor is with resistance drift; ◆ The refrigerant in the system is insufficient; ◆ The outdoor unit LEVb, SV31, SV32, etc. cannot be turned on normally; ◆ The unit condensation side is with poor heat transfer function. ◆ The operation environment is beyond the allowed range. 				

Failure code Outdoor digital display tube: 28 Indoor wired controller: 1C	Indoor unit LED status	LED5		Failure description: High pressure sensor Pd failure
		20 times		
	Outdoor unit LED status	LED1	LED2	
Normal		Normal		
1. Model	Failure diagnosis and troubleshooting			
MRV 5 series	Diagnosis	Troubleshooting		
2. Abnormity detection method	<pre> graph TD A{Check if the corresponding connector of sensor is normal} -- N --> B[Replace it correctly by after-sales personnel on site.] A -- Y --> C{Check if the voltage characteristic of the sensor is normal} C -- N --> D[Replace it correctly by after-sales personnel on site.] C -- Y --> E{Check if the pressure loop acquired by the computer board is normal} E -- Y --> F[Replace it correctly by after-sales personnel on site.] </pre>			
3. Abnormity confirmation conditions				
It is detected that the AD value is below 11 (open circuit) or above 1012 (short circuit) for 30 seconds continuously, and no alarm is given during defrosting and within 3 minutes at the end of defrosting.				
4. Possible causes				
<ul style="list-style-type: none"> ◆ The connection of pressure sensor is not secure; ◆ The pressure sensor is broken; ◆ The pressure acquired by PCB is not accurate. 				

Failure code Outdoor digital display tube: 29 Indoor wired controller: 1D	Indoor unit LED status	LED5		Failure description: Low pressure sensor Ps failure
	Outdoor unit LED status	20 times		
		LED1	LED2	
		Normal	Normal	
1. Model	Failure diagnosis and troubleshooting			
MRV 5 series	Diagnosis	Troubleshooting		
2. Abnormity detection method	<pre> graph TD A{Check if the corresponding connector of sensor is normal} -- N --> B[Replace it correctly by after-sales personnel on site.] A -- Y --> C{Check if the voltage characteristic of the sensor is normal} C -- N --> D[Replace it correctly by after-sales personnel on site.] C -- Y --> E{Check if the pressure loop acquired by the computer board is normal} E -- N --> F[Replace it correctly by after-sales personnel on site.] </pre>			
3. Abnormity confirmation conditions				
It is detected that the AD value is below 11 (open circuit) or above 1012 (short circuit) for 30 seconds continuously, and no alarm is given during defrosting and within 3 minutes at the end of defrosting.				
4. Possible causes				
<ul style="list-style-type: none"> ◆ The connection of pressure sensor is not secure; ◆ The pressure sensor is broken; ◆ The pressure acquired by PCB is not accurate. 				

Failure code Outdoor digital display tube: 30-0, 1 Indoor wired controller: 1E	Indoor unit LED status	LED5		Failure description: High pressure switch HPS1 and HPS2 failure
		20 times		
	Outdoor unit LED status	LED1	LED2	
Normal		Normal		
1. Model	Failure diagnosis and troubleshooting			
MRV 5 series	Diagnosis	Troubleshooting		
2. Abnormity detection method	<pre> graph TD A{Check if the corresponding connector of pressure switch is normal} -- N --> B[Replace it correctly by after-sales personnel on site.] A -- Y --> C{Check if the pressure switch signal loop acquired by the computer board is normal} C -- Y --> D[Replace it correctly by after-sales personnel on site.] C -- N --> E{Check if the high pressure reaches 4.0MPa when the pressure switch is turned off} E -- Y --> F{Check if the high pressure stop valve is turned on or the high pressure side is blocked} F -- Y --> G[Rectify it correctly by after-sales personnel on site.] F -- N --> H{Check the outdoor fan for normal operation when cooling} H -- N --> I[Rectify it correctly by after-sales personnel on site.] H -- Y --> J{Check if the refrigerant is excessive} J -- Y --> K[Rectify it correctly by after-sales personnel on site. [Note] Confirm if non-condensable gases enter the system.] J -- N --> L{Check if it is out of the operating range of units.} L -- Y --> M[Notify the user to use it within the operating range of units by after-sales personnel.] </pre>			
3. Abnormity confirmation conditions				
The high pressure switch is turned off for 2s.				
4. Possible causes				
<ul style="list-style-type: none"> ◆ The connection of pressure switch is not secure; ◆ Pressure switch is broken; ◆ The pressure switch signal acquired by the PCB is incorrect; ◆ The high pressure side of the unit is blocked; ◆ The outdoor fan stops operating when cooling; ◆ The refrigerant is excessive; ◆ It is out of the operating range of units. 				

FFailure code Outdoor digital display tube: 32-0, 1 Indoor wired controller: 20	Indoor unit LED status		LED5		Failure description: Defrosting temperature sensor failure: Tsc0 and Tliqc
	Outdoor unit LED status		20 times		
			LED1	LED2	
		Normal	Normal		
1. Model	Failure diagnosis and troubleshooting				
MRV 5 series	Diagnosis			Troubleshooting	
2. Abnormity detection method	<pre> graph TD D1{Check if the corresponding connector of sensor is normal} D2{Check if resistance temperature characteristic of the sensor is normal} D3{Check if the temperature loop acquired by the computer board is abnormal} D1 -- Y --> D2 D1 -- N --> T1[Replace it correctly by after-sales personnel on site.] D2 -- Y --> D3 D2 -- N --> T2[Replace it correctly by after-sales personnel on site.] D3 -- N --> T3[Replace it correctly by after-sales personnel on site.] style T1 fill:none,stroke:none style T2 fill:none,stroke:none style T3 fill:none,stroke:none </pre>				
3. Abnormity confirmation conditions					
It is detected that the AD value is below 11 (open circuit) or above 1012 (short circuit) for 60 seconds continuously, the cooling mode operates the sensor abnormity without troubleshooting it, and no alarm is given during defrosting and within 3 minutes at the end of defrosting.					
4. Possible causes					
<ul style="list-style-type: none"> ◆ The connection of sensor is not secure; ◆ The sensor is broken; ◆ The sensor is with resistance drift; ◆ The temperature acquired by PCB is not accurate. 					

Failure code Outdoor digital display tube: 33-0, 2, 3 Indoor wired controller: 21	Indoor unit LED status	LED5		Failure description: AT24C04 EEPROM communication failure AT24C04 EEPROM data check failure IM EEPROM data or communication failure
		20 times		
	Outdoor unit LED status	LED1	LED2	
Normal		Normal		
1. Model	Diagnosis and troubleshooting			
MRV 5 series	Diagnosis		Troubleshooting	
2. Abnormity detection method	<pre> graph TD A{Turn BM1_1 and M1_2 to "OFF", energize again, and then check if the failure is cleared.} -- Y --> B{Replace EE.} </pre>			
◆ Incorrect EEPROM data.				
3. Abnormity confirmation conditions				
EEPROM communication error; EEPROM data check error (model ID, checksum, etc.); EEPROM data logic error (wider data range, wrong order, etc.)				
4. Possible causes				
◆ EEPROM is an old version, while the program is a new version.				

Failure code Outdoor digital display tube: 34-0, 1 Indoor wired controller: 22	Indoor unit LED status	LED5		Failure description: Outdoor compressor discharging temperature (Td1, Td2).too high failure
		20 times		
	Outdoor unit LED status	LED1	LED2	
Normal		Normal		
1. Model	Diagnosis and troubleshooting			
MRV 5 series	Diagnosis		Troubleshooting	
2. Abnormity detection method	<pre> graph TD A{Check if the resistance of discharging temperature sensor is correct.} -- N --> B[Replace the discharging temperature sensor by after-sales personnel on site.] A -- Y --> C{Check if the refrigerant in the system is with leakage or insufficient.} C -- N --> D[Replace it correctly by after-sales personnel on site and ensure the refrigerant is enough.] C -- Y --> E{Check if the outdoor heat exchange is normal when cooling, and check if the indoor heat exchange is normal when heating.} E -- N --> F[Replace it correctly by after-sales personnel on site.] E -- Y --> G{Check if the outdoor unit LEVb, SV31 and SV32 cannot be turned on normally.} G -- N --> H[Troubleshoot and replace it correctly by after-sales personnel on site.] G -- Y --> I{Check if the allowed operation range is exceeded.} I -- Y --> J[Use the unit in accordance with its allowed operation range.] </pre>			
3. Abnormity confirmation conditions				
Toil1/Toil2≥120°C.				
4. Possible causes				
<ul style="list-style-type: none"> ◆ The oil temperature sensor is with resistance drift; ◆ The refrigerant in the system is insufficient; ◆ The outdoor unit LEVb, SV31 and SV32 cannot be turned on normally. ◆ The unit condensation side is with poor heat transfer function; ◆ The operation environment is beyond the allowed range. 				

Failure code Outdoor digital display tube: 35-0, 1 Indoor wired controller: 23	Indoor unit LED status	LED5		Failure description: Four-way valve reversing failure
		20 times		
	Outdoor unit LED status	LED1	LED2	
Normal		Normal		
1. Model	Diagnosis and troubleshooting			
MRV 5 series	Diagnosis	Troubleshooting		
2. Abnormity detection method	<pre> graph TD A{Check if the difference between high and low pressure of system exceeds 0.6MPa after start and before failure alarm} -- N --> B{Check if the refrigerant in the system is with leakage or insufficient.} B -- Y --> B1[Replace it correctly after sales on site and ensure the refrigerant is enough.] B -- N --> C{Check if the detection value of low pressure sensor is correct.} C -- Y --> C1[Troubleshoot if the detection value of Tsuc or Tdef1/2 sensor is correct and if the connection is correct. Rectify it correctly by after-sales personnel on site.] C -- N --> D{Check if the four-way valve of outdoor unit is with backflow and if the suction pipe filter of compressor is blocked.} D -- Y --> D1[Troubleshoot and rectify it correctly by after-sales personnel on site.] D -- N --> E{Check if it operates normally after replacing with a normal driver module.} E -- N --> E1[Replace the driver module correctly.] E -- Y --> F{Check if the allowed operation range is exceeded.} F -- Y --> F1[Use the unit in accordance with its allowed operation range.] </pre>			
3. Abnormity confirmation conditions				
In case of meeting one of the following conditions after the four-way valve is energized for 3min and lasts for 10s, it is judged as switching completion: • $T_{suc}-T_{def}\geq 10^{\circ}C$ • $P_d-P_s\geq\beta Mpa$ ($T_{ao}>10^{\circ}C$, $\beta=0.60$; $T_{ao}\leq 10^{\circ}C$, $\beta=0.40$), otherwise, it is judged as failure.				
4. Possible causes				
<ul style="list-style-type: none"> The detection value of high/low pressure sensor is incorrect; The refrigerant in the system is insufficient; The four-way valve cannot be switched normally or with backflow. The filter of compressor suction pipe is blocked by foreign matters; The detection value of T_{suc} or $T_{def1/2}$ sensor is incorrect; The power module cannot drive the compressor operating normally; <ul style="list-style-type: none"> The operation environment is beyond the allowed range. 				

Failure code Outdoor digital display tube: 36-0, 1 Indoor wired controller: 24	Indoor unit LED status	LED5		Failure description: Outdoor compressor oil temperature (Toil1, Toil2) too low failure
		20 times		
	Outdoor unit LED status	LED1	LED2	
Normal		Normal		
1. Model	Diagnosis and troubleshooting			
MRV 5 series	Diagnosis		Troubleshooting	
2. Abnormality detection method	<pre> graph TD A{Check if the resistance of oil temperature sensor is correct.} -- N --> B[Replace the oil temperature sensor by after-sales personnel on site.] A -- Y --> C{Check if the sensor probe is secure and if the position is correct.} C -- N --> D[Replace it correctly by after-sales personnel on site. [Note]: Check if it is inserted, connected and intersected with another compressor, especially when a single compressor operates.] C -- Y --> E{Check if the indoor unit LEV of "OFF" is closed tightly and if the indoor unit fan of "ON" is normal.} E -- N --> F[Replace the poor valve (with leakage) and fan correctly by after-sales personnel on site.] E -- Y --> G{Check if the terminal of outdoor unit LEVb, SV31 and SV32 is connected properly or is closed tightly.} G -- N --> H[Replace the poor valve (with leakage) and fan correctly by after-sales personnel on site.] G -- Y --> I{Check if the outdoor unit LEVa1, 2 and LEVb are connected properly and correctly when heating.} I -- N --> J[Replace it correctly by after-sales personnel on site.] I -- Y --> K{Check if the unit is filled with excessive refrigerant.} K -- N --> L[Check if the computer board can normally control the related electronic expansion valve and solenoid valve, if not, replace it.] K -- Y --> M[Fill with regular refrigerant in accordance with standard quantity.] </pre>			
<ul style="list-style-type: none"> ◆ Check if the temperature detected by the oil temperature sensor is correct. ◆ Check if the outdoor unit SV31, SV32, LEVb, etc. are with abnormal leakage and check if the detected temperature is correct; ◆ Check if the shutdown indoor unit LEV of unit is closed tightly, and if the running indoor unit fan operates normally. 				
3. Abnormality confirmation conditions	Toil1/Toil2-CT≤10°C lasts for 5min.			
4. Possible causes	<ul style="list-style-type: none"> ◆ The probe of oil temperature sensor falls off or is with unsecure connection; ◆ The probe of oil temperature sensor is misplaced; ◆ The oil temperature sensor is with resistance drift; ◆ The outdoor unit LEVb, SV31 and SV32 are with leakage; ◆ The terminal of outdoor unit LEVa1, 2 and LEVb is connected incorrectly; ◆ For the unit, there is LEV leakage in shutdown indoor unit and non-operation of fan in operating indoor unit; ◆ The system refrigerant is too much ◆ The operation environment is beyond the allowed range. 			

Failure code Outdoor digital display tube: 39-0 Indoor wired controller: 27	Indoor unit LED status	LED5		Failure description: Low pressure sensor Ps too low protection
		20 times		
	Outdoor unit LED status	LED1	LED2	
Normal		Normal		
1. Model	Diagnosis and troubleshooting			
MRV 5 series	Diagnosis		Troubleshooting	
2. Abnormity detection method	<pre> graph TD A{Check if the low pressure of system is below 0.05MPa before failure alarm;} -- Y --> B{Check if the refrigerant in the system is with leakage or insufficient.} A -- N --> C{Check if the detection value of low pressure sensor is correct.} B -- Y --> B1[Replace it correctly by after-sales personnel on site and ensure the refrigerant is enough.] B -- N --> C C -- N --> C1[Rectify it correctly by after-sales personnel on site.] C -- Y --> D{Check if the pipelines on the low pressure side or liquid side of the unit are blocked.} D -- Y --> D1[Troubleshoot and rectify it correctly by after-sales personnel on site. [Note]: Check if all stop valves can be turned on and if the air-returning pipe filter of compressor is blocked.] D -- N --> E{Check if the allowed operation range is exceeded.} E -- N --> E1[Check if all the electronic expansion valves of the indoor unit can be turned on normally.] E -- Y --> E2[Use the unit in accordance with its allowed operation range.] </pre>			
3. Abnormity confirmation conditions	<p>Alarm to shut down if the followings are detected for 5min: cooling: Ps< 0.10Mpa; heating: Ps< 0.05Mpa; oil return: Ps<0.03Mpa after the compressor operates. (except residual operation)</p>			
4. Possible causes	<ul style="list-style-type: none"> ◆ The detection value of low pressure sensor is incorrect; ◆ The refrigerant in the system is insufficient or the system is with air leakage; ◆ The pipelines on the low pressure side or liquid side of the unit are blocked; ◆ The outdoor unit cannot be turned on normally due to failure to open electronic expansion of outdoor heat exchanger when heating; ◆ The operation environment is beyond the allowed range. 			

Failure code Outdoor digital display tube: 39-1 Indoor wired controller: 27	Indoor unit LED status	LED5		Failure description: Compressor ratio ϵ too high protection
		20 times		
	Outdoor unit LED status	LED1	LED2	
Normal		Normal		
1. Model	Diagnosis and troubleshooting			
MRV 5 series	Diagnosis	Troubleshooting		
2. Abnormity detection method	<pre> graph TD A{Check if the system operating compression ratio is above 8 before failure alarm.} -- Y --> B{Check if the refrigerant in the system is with leakage or insufficient.} A -- N --> C{Check if the detection value of high-low pressure sensor is correct.} B -- Y --> B1[Use the unit in accordance with its allowed operation range.] B -- N --> C C -- N --> C1[Rectify it correctly by after-sales personnel on site.] C -- Y --> D{Check if the pipelines on the low pressure side or liquid side of the unit are blocked.} D -- Y --> D1[Troubleshoot and rectify it correctly by after-sales personnel on site. [Note]: Simultaneously, check if all stop valves can be turned on.] D -- N --> E{Check if the allowed operation range is exceeded.} E -- N --> E1[Check if all the electronic expansion valves of the indoor unit can be turned on normally.] E -- Y --> E2[Use the unit in accordance with its allowed operation range.] </pre>			
3. Abnormity confirmation conditions				
Alarm to shut down if the compression ratio $\epsilon > 8.0$ is detected for continuous 5min after the compressor operates; alarm to shut down if the compression ratio $\epsilon > 9.0$ or $\epsilon > 8.5$ when cooling or heating for 1min separately.				
4. Possible causes				
<ul style="list-style-type: none"> ◆ The detection value of high/low pressure sensor is incorrect; ◆ The refrigerant in the system is insufficient or the system is with air leakage; ◆ The pipelines on the high pressure side or liquid side of the unit are blocked; ◆ The outdoor unit cannot be turned on normally due to failure to open electronic expansion of outdoor heat exchanger when heating; ◆ The operation environment is beyond the allowed range. 				

Failure code Outdoor digital display tube: 40 Indoor wired controller: 28	Indoor unit LED status		LED5		Failure description: High pressure sensor Pd too high protection
	Outdoor unit LED status		20 times		
			LED1	LED2	
		Normal	Normal		
1. Model	Diagnosis and troubleshooting				
MRV 5 series	Diagnosis			Troubleshooting	
2. Abnormity detection method	<p>◆ Check if the high pressure acquired by the PCB is correct;</p> <p>◆ Check if the voltage characteristic corresponding to the pressure sensor is correct;</p> <p>◆ Check if the high pressure side of the system is blocked;</p> <p>◆ Check the outdoor fan for normal operation when cooling.</p>				
3. Abnormity confirmation conditions	<p>The high pressure switch is turned off for 2s.</p>				
4. Possible causes	<p>◆ The pressure sensor is broken;</p> <p>◆ The pressure sensor signal acquired by the PCB is incorrect;</p> <p>◆ The high pressure side of the unit is blocked;</p> <p>◆ The outdoor fan stops operating when cooling;</p> <p>◆ The refrigerant is excessive;</p> <p>◆ It is out of the operating range of units.</p>				
<pre> graph TD D1{Check if the voltage characteristic of the corresponding pressure sensor is normal.} D2{Check if the pressure sensor signal acquisition loop of the computer board is normal.} D3{Check if the high pressure reaches 4.0MPa upon failure alarm.} D4{Check if the high pressure stop valve is turned on or the high pressure side is blocked.} D5{Check the outdoor fan for normal operation when cooling.} D6{Check if the refrigerant is excessive.} D7{Check if the allowed operation range is exceeded} D1 -- N --> T1[Replace it correctly by after-sales personnel on site.] D1 -- Y --> D2 D2 -- N --> T2[Replace it correctly by after-sales personnel on site.] D2 -- Y --> D3 D3 -- Y --> D4 D3 -- N --> D4 D4 -- Y --> T3[Rectify it correctly by after-sales personnel on site.] D4 -- N --> D5 D5 -- N --> T4[Rectify it correctly by after-sales personnel on site.] D5 -- Y --> D6 D6 -- Y --> T5[Rectify it correctly by after-sales personnel on site. Note: confirm if the system including the noncondensable gas] D6 -- N --> D7 D7 -- Y --> T6[Notify the user to use it within the operating range of units by after-sales personnel.] </pre>					

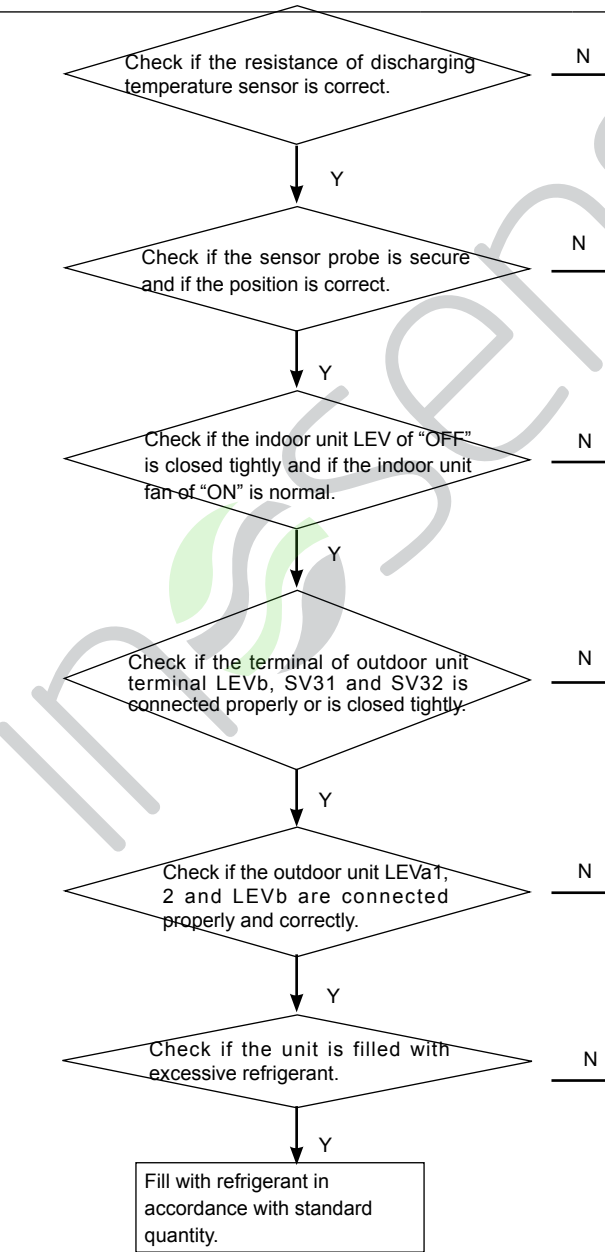
Failure code Outdoor digital display tube: 43-0, 1 Indoor wired controller: 2B	Indoor unit LED status	LED5		Failure description: Outdoor unit compressor discharging temperature (Td1, Td2) too low failure
		20 times		
	Outdoor unit LED status	LED1	LED2	
Normal		Normal		
1. Model	Diagnosis and troubleshooting			
MRV 5 series	Diagnosis		Troubleshooting	
2. Abnormity detection method				
3. Abnormity confirmation conditions	Td1/Td2-CT≤10°C lasts for 5min.			
4. Possible causes	<ul style="list-style-type: none"> ◆ The probe of oil temperature sensor falls off or is with unsecure connection; ◆ The probe of oil temperature sensor is misplaced; ◆ The oil temperature sensor is with resistance drift; ◆ The outdoor unit LEVb, SV31 and SV32 are with leakage; ◆ The terminal of outdoor unit LEVa1, 2 and LEVb is connected incorrectly; ◆ For the unit, there is LEV leakage in shutdown indoor unit and non-operation of fan in operating indoor unit; ◆ The system is filled with excessive refrigerant. ◆ The operation environment is beyond the allowed range. 			

Failure code Outdoor digital display tube: 45 Indoor wired controller: 2D	Indoor unit LED status	LED5		Failure description: Communications between outdoor units failure.
		20 times		
	Outdoor unit LED status	LED1	LED2	
Normal		Normal		
1. Model	Diagnosis and troubleshooting			
MRV 5 series	Diagnosis		Troubleshooting	
2. Abnormity detection method	<pre> graph TD A{Check if the communication wire between the outdoor units is normal.} -- N --> B[Replace it correctly by after-sales personnel on site.] A -- Y --> C{Check if the address DIP switch of outdoor unit is correct.} C -- N --> D[Reset it correctly by after-sales personnel on site.] C -- Y --> E{Check if there is interference source in the position where the outdoor unit is installed.} E -- Y --> F[Clear the interference source.] E -- N --> G{Power off the outdoor unit and research it.} G -- N --> H{Replace the outdoor unit PCB} </pre>			
3. Abnormity confirmation conditions				
No communication for 30s (E)				
4. Possible causes				
<ul style="list-style-type: none"> ◆ Poor communication wire: short circuit or disconnection; ◆ Non-corresponding communication wire A, B and C; ◆ Incorrect connection of outdoor unit communication port of PCB; ◆ Interference source, which causes unstable communication of outdoor unit. 				

Failure code Outdoor digital display tube: 46-0, 1 Indoor wired controller: 2E	Indoor unit LED status	LED5		Failure description: Communication with INV1 and INV2 module board failure
	Outdoor unit LED status	20 times		
		LED1	LED2	
		Normal	Normal	
1. Model	Diagnosis and troubleshooting			
MRV 5 series	Diagnosis		Troubleshooting	
2. Abnormality detection method	<pre> graph TD A{Check if the interface board is connected with the wiring harness of variable frequency board correctly.} -- N --> B[Replace it correctly by after-sales personnel on site.] A -- Y --> C{Check if the communication wire is disconnected;} C -- Y --> D[Replace it correctly by after-sales personnel on site.] C -- N --> E{Test if the voltage of the two central needles of CN28 and CN57 changes by a multimeter.} E -- Y --> F[Replace the interface board of outdoor unit.] </pre>			
3. Abnormality confirmation conditions				
No communication for 30s				
4. Possible causes				
<ul style="list-style-type: none"> ◆ Check if the communication wire correspondence of inverter module is correct; ◆ Check if the communication wire is disconnected; ◆ Poor communication wire: disconnection; ◆ Incorrect correspondence of INV1 and INV2; incorrect connection of outdoor unit communication port of PCB; ◆ Poor inverter board or connection board 				

Failure code Outdoor digital display tube: 46-4, 5 Indoor wired controller: 2E	Indoor unit LED status	LED5		Failure description: Communication with fan motor module board 1, 2 failure
		20 times		
	Outdoor unit LED status	LED1	LED2	
Normal		Normal		
1. Model	Diagnosis and troubleshooting			
MRV 5 series	Diagnosis		Troubleshooting	
2. Abnormity detection method	<pre> graph TD A{Check if the connection of fan motor communication wire and compressor module wire is correct} -- N --> B[Replace it correctly by after-sales personnel on site.] A -- Y --> C{Check if the communication wire of fan motor is disconnected;} C -- Y --> D[Replace it correctly by after-sales personnel on site.] C -- N --> E{Test if the voltage of the two central needles of CN28 and CN57 changes by a multimeter.} E -- N --> F[Replace the interface board of outdoor unit.] E -- Y --> G{Check if the compressor module connected with the fan motor is OK} G -- N --> H{Replace the compressor module} G -- Y --> I[] </pre>			
3. Abnormity confirmation conditions				
Fan motor has a host computer or compressor inverter, no communication for 30s				
4. Possible causes				
<ul style="list-style-type: none"> ◆ Poor communication wire: disconnection; ◆ Incorrect correspondence of INV1 and INV2; incorrect connection of outdoor unit communication port of PCB; ◆ Poor inverter board or connection board 				

Failure code Outdoor digital display tube: 47 Indoor wired controller: 2F	Indoor unit LED status	LED5		Failure description: Communication with wireless communication module failure
		20 times		
	Outdoor unit LED status	LED1	LED2	
Normal		Normal		
1. Model	Diagnosis and troubleshooting			
MRV 5 series	Diagnosis		Troubleshooting	
2. Abnormity detection method	<pre> graph LR A{Check if the dip switch of BM2-1 and BM2-2 is OFF position} -- N --> B[Change the dip switch by after-sales personnel on site.] </pre>			
3. Abnormity confirmation conditions				
Can't detect the wireless communication module within 120 seconds continuously, alarm				
4. Possible causes				
◆ The dip switch of BM2-1 and BM2-2 is wrong				

Failure code Outdoor digital display tube: 51-0,1,2,3 Indoor wired controller: 33	Indoor unit LED status	LED5		Failure description: LEVa1,2 and LEVb,c over current protection
	Outdoor unit LED status	20 times		
		LED1	LED2	
		Normal	Normal	
1. Model	Diagnosis and troubleshooting			
MRV 5 series	Diagnosis		Troubleshooting	
2. Abnormity detection method	<pre> graph TD A{Check if the wires of electronic expansion valve coil is short circuit} -- Y --> B[Replace electronic expansion valve coil] A -- N --> C{Check if the PCB LED3 is flashing when the electronic expansion valve is operating} C -- Y --> D[Replace PCB] </pre>			
3. Abnormity confirmation conditions				
LEV driver chip detection				
4. Possible causes				
◆ The wires of electronic expansion valve coil short circuit ◆ LEV drive output circuit anomalies				

Failure code Outdoor digital display tube: 52-0,1,2,3 Indoor wired controller: 34	Indoor unit LED status		LED5		Failure description: LEVa1,2 and LEVb,c open circuit
	Outdoor unit LED status		20 times		
			LED1	LED2	
	Normal	Normal			
1. Model	Diagnosis and troubleshooting				
MRV 5 series	Diagnosis			Troubleshooting	
2. Abnormality detection method	<pre> graph TD A{Check if the electronic expansion valve coil terminal plug well} -- N --> B[Reconnected by after-sales personnel on site.] A -- Y --> C{Check if the electronic expansion valve coil harness, the terminal is good} C -- Y --> D[Replace the electronic expansion valve coil by after-sales personnel on site.] C -- N --> E{Check whether the PCB LEV circuit is damaged} E -- Y --> F[Replace PCB] </pre>			<p>Reconnected by after-sales personnel on site.</p> <p>Replace the electronic expansion valve coil by after-sales personnel on site.</p> <p>Replace PCB</p>	
◆ LEV driver chip detection					
3. Abnormality confirmation conditions					
LEV driver chip detection					
4. Possible causes	<ul style="list-style-type: none"> ◆ The electronic expansion valve coil connector is disengaged or misplaced ◆ Electronic expansion valve coil harness breaks ◆ LEV drive circuit is open 				

Failure code Outdoor digital display tube: 74 Indoor wired controller: 4A	Indoor unit LED status		LED5		Failure description: Emergency stop function switch failure
	Outdoor unit LED status		20 times		
			LED1	LED2	
	Normal	Normal			
1. Model	Diagnosis and troubleshooting				
MRV 5 series	Diagnosis			Troubleshooting	
2. Abnormity detection method					
3. Abnormity confirmation conditions					
4. Possible causes					
◆ Check if the CN18 is open circuit					
◆ CN18 is open circuit					

Failure code Outdoor digital display tube: 75-0 Indoor wired controller: 4B	Indoor unit LED status	LED5		Failure description: Pressure difference between high and low pressure too low failure
		20 times		
	Outdoor unit LED status	LED1	LED2	
		Normal	Normal	

1. Model	Diagnosis and troubleshooting	
MRV 5 series	Diagnosis	Troubleshooting
2. Abnormity detection method		
3. Abnormity confirmation conditions		
4. Possible causes		
<ul style="list-style-type: none"> ◆ Check if the difference between high and low pressure of system exceeds 0.4MPa after start and before failure alarm; ◆ Check if the unit lack of refrigerant. ◆ Check the four-way valve of unit for normal switching and free from backflow. ◆ Check if the detection value of high/low pressure sensor is correct. ◆ Check if the unit is beyond the operation range. 		
75-0: Pd-Ps≤0.1Mpa within 1min upon the INV compressor starts. 75-4: Pd-Ps≤0.4Mpa lasts for 3min.		
<ul style="list-style-type: none"> ◆ The detection value of high/low pressure sensor is incorrect; ◆ The refrigerant in the system is insufficient; ◆ The four-way valve cannot be switched normally or with backflow. The power module cannot drive the compressor operating normally;		
<ul style="list-style-type: none"> ◆ The inverter compressor is with serious inter deterioration, which makes it difficult to form difference between high and low pressure. ◆ The operation environment is beyond the allowed range. 		

Failure code Outdoor digital display tube: 76-0, 1, 2 Indoor wired controller: 4C	Indoor unit LED status	LED5		Failure description: Incorrect settings of quantity, address or capacity for outdoor unit
	Outdoor unit LED status	20 times		
		LED1	LED2	
		Normal	Normal	
1. Model	Diagnosis and troubleshooting			
MRV 5 series	Diagnosis	Troubleshooting		
2. Abnormity detection method	<pre> graph TD D1{Check if the horse power of outdoor unit changes.} D2{Check if the quantity of outdoor unit changes.} D3{Check if the address setting of outdoor unit is correct.} D1 -- Y --> T1[Research and lock the outdoor unit.] D1 -- N --> D2 D2 -- Y --> T2[Research and lock the outdoor unit.] D2 -- N --> D3 D3 -- Y --> T3[Replace it correctly by after-sales personnel on site. Research and lock the unit.] style T1 fill:none,stroke:none style T2 fill:none,stroke:none style T3 fill:none,stroke:none </pre>			
3. Abnormity confirmation conditions				
Quantity of sub-unit setting does not conform to host EEPROM data; address of sub-unit setting does not conform to host EEPROM data; horse power setting of sub-unit does not conform to host EEPROM data.				
4. Possible causes				
<ul style="list-style-type: none"> ◆ The quantity of connected unit changes; ◆ The horse power of outdoor unit of the same system changes; ◆ The address setting of the same system changes; 				

Failure code Outdoor digital display tube: 83 Indoor wired controller: 53	Indoor unit LED status	LED5		Failure description: Outdoor unit model are set incorrectly
		20 times		
	Outdoor unit LED status	LED1	LED2	
Normal		Normal		
1. Model	Failure diagnosis and troubleshooting			
MRV 5 series	Diagnosis		Troubleshooting	
2. Abnormity detection method	<pre> graph TD A{Check if the dip switch setting is correct} -- Y --> B[Adjusting the setting and re-search outdoor and locked] A -- N --> C{Check if the BM3-1 / 2/3 dip switch is conduction state} C -- N --> D[Replace the PCB] C -- Y --> E[Set the BM3-1 / 2/3 dial repeatedly to ensure the disconnected status] </pre>			
3. Abnormity confirmation conditions				
4. Possible causes				
◆ BM3-1 / 2/3 dip switch setting wrong or bad continuity.				

Failure code Outdoor digital display tube: 110-0,1 Indoor wired controller: 6E	Indoor unit LED status	LED5		Failure description: Compressor module hardware over current
		20 times		
	Outdoor unit LED status	LED1	LED2	
Normal		Normal		
1. Model	Failure diagnosis and troubleshooting			
MRV 5 series	Diagnosis		Troubleshooting	
2. Abnormity detection method	<pre> graph TD A{Check if the supply voltage is normal} -- N --> B[Rectify on site by after-sales personnel.] A -- Y --> C{Check if the electrical cabinet and compressor wires are secured, the UVW is correctly connected and the variable frequency board and module board are wired correctly.} C -- N --> D[Rectify on site by after-sales personnel.] C -- Y --> E{Check if the power module is normal} E -- N --> F[Replace on site by after-sales personnel.] E -- Y --> G{Check if there is other failure, 112, and 114} G -- N --> H[Replace the compressor.] G -- Y --> I{Check if the compressor, resistance and insulation are normal} I -- N --> J[Detect by exclusion.] I -- Y --> K[Troubleshoot each failure.] </pre>			
3. Abnormity confirmation conditions				
Over current of module hardware				
4. Possible causes				
<ul style="list-style-type: none"> ◆ The module alarms FO failure due to poor heat dissipation; ◆ The module alarms failure as it is broken down; ◆ Liquid shock is found in compressor, which results in over current upon starting or operating; ◆ The winding resistance of compressor is large; ◆ UVW wiring is wrongly connected or the inverter board and module board are wired insecurely. 				

Failure code Outdoor digital display tube: 110-4, 5 Indoor wired controller: 6E	Indoor unit LED status	LED5		Failure description: Fan motor module hardware over current
	Outdoor unit LED status	20 times		
		LED1	LED2	
		Normal	Normal	
1. Model	Failure diagnosis and troubleshooting			
MRV 5 series	Diagnosis		Troubleshooting	
2. Abnormity detection method	<pre> graph TD A{Check if the supply voltage is normal} -- N --> B[Rectify on site by after-sales personnel.] A -- Y --> C{Check if electrical box wiring is correct, the fan wire is securely connected} C -- N --> D[Rectify on site by after-sales personnel.] C -- Y --> E{Rotate the fan by hand, check if rotation is smooth} E -- N --> F[Replace fan motor] E -- Y --> G{Left and right fan DC + (red line), DC- (white line) voltage is normal DC540V} G -- N --> H[Check the capacitor board voltage] G -- Y --> I{Is there any other fault 112,114?} I -- N --> J[Detect by exclusion.] </pre>			
3. Abnormity confirmation conditions				
Fan built-in drive hardware over-current				
4. Possible causes				
<ul style="list-style-type: none"> ◆ Check if the motor DC +/- loop is short circuit; ◆ Check fan blade load is stuck, rotation is smooth; ◆ Check if the compressor resistance is normal, ◆ Check the motor resistance is normal; 				
<ul style="list-style-type: none"> ◆ The power supply of fan motor capacitor board is poor ◆ Fan blade load is stuck. ◆ Motor built-in driver is not good 				

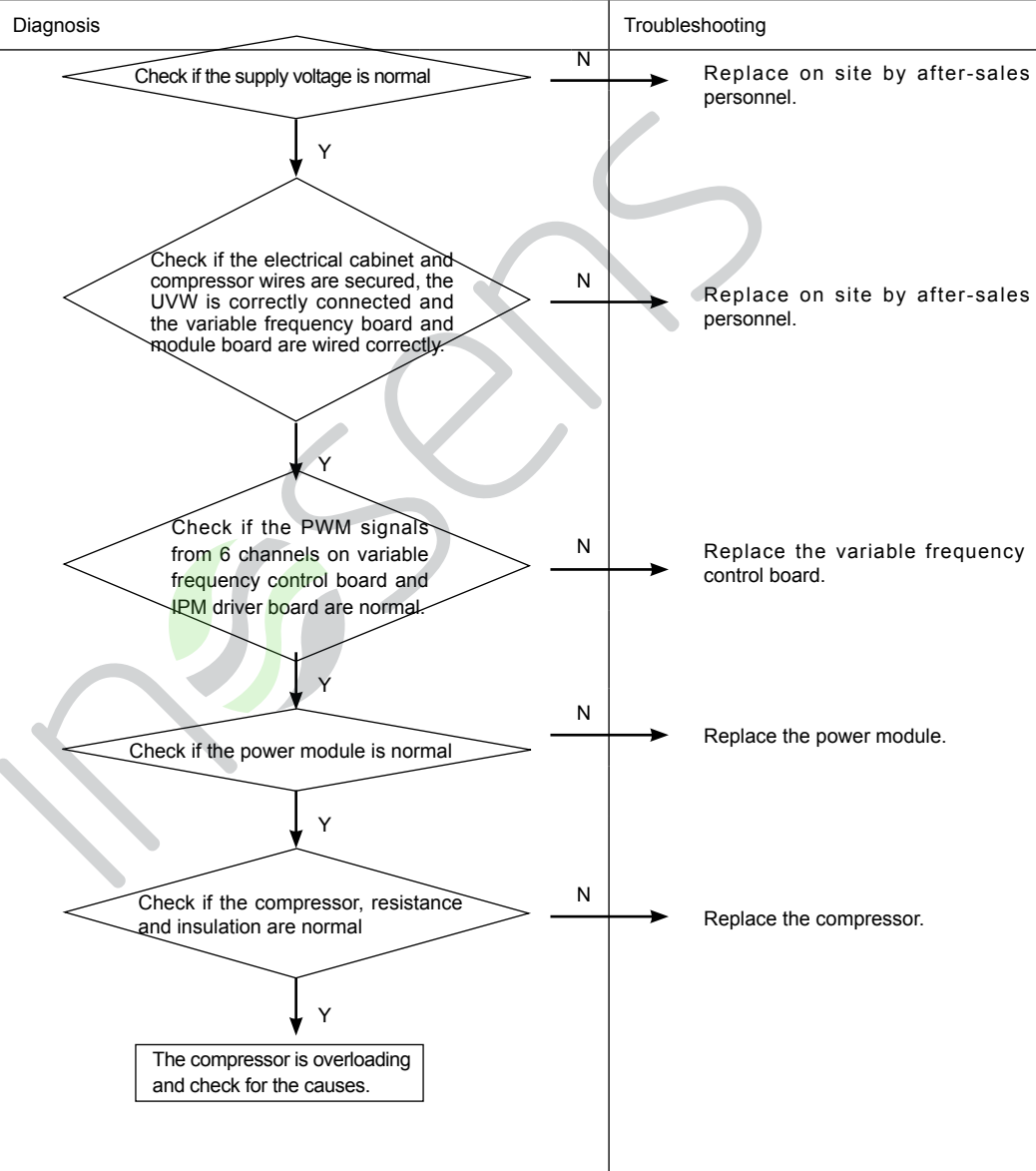
Failure code Outdoor digital display tube: 111-0,1 Indoor wired controller: 6F	Indoor unit LED status	LED5		Failure description: Compressor out of control
		20 times		
	Outdoor unit LED status	LED1	LED2	
		Normal	Normal	
1. Model	Failure diagnosis and troubleshooting			
MRV 5 series	Diagnosis	Troubleshooting		
2. Abnormity detection method	 <pre> graph TD A{Check if the supply voltage is normal} -- N --> B[Replace on site by after-sales personnel.] A -- Y --> C{Check if the electrical cabinet and compressor wires are secured, the UVW is correctly connected and the variable frequency board and module board are wired correctly.} C -- N --> D[Replace on site by after-sales personnel.] C -- Y --> E{Check if the PWM signals from 6 channels on variable frequency control board and IPM driver board are normal.} E -- N --> F[Replace the variable frequency control board.] E -- Y --> G{Check if the power module is normal.} G -- N --> H[Replace the power module.] G -- Y --> I{Check if the compressor, resistance and insulation are normal.} I -- N --> J[Replace the compressor.] I -- Y --> K[The compressor is overloading and check for the causes.] </pre>			
3. Abnormity confirmation conditions	Over current of module hardware			
4. Possible causes	<ul style="list-style-type: none"> ◆ The module alarms failure as it broke down; ◆ Liquid shock is found in compressor which results in over current upon starting or operating; ◆ The compressor winding is burned out; ◆ UVW wiring is wrongly connected or the inverter board and module board are wired insecurely. 			

Failure code Outdoor digital display tube: 112-0,1 Indoor wired controller: 70	Indoor unit LED status		LED5		Failure description: Compressor module radiator temp. too high
	Outdoor unit LED status		20 times		
			LED1	LED2	
		Normal	Normal		
1. Model	Failure diagnosis and troubleshooting				
MRV 5 series	Diagnosis			Troubleshooting	
2. Abnormity detection method	<pre> graph TD D1{Check if the cooling fan rotates and the sensor is normal} D2{Check if the module is secured and the cooling silica gel is even up} D3{Check if has 117 failure} R1[Compressor overload to check the cause of over load] D1 -- N --> T1[Troubleshoot the fan and PCB terminal for 220V voltage output.] D1 -- Y --> D2 D2 -- N --> T2[Secure the module and paint with radiating silica gel evenly.] D2 -- Y --> D3 D3 -- N --> T3[Replace the power module.] D3 -- Y --> R1 </pre>				
3. Abnormity confirmation conditions					
Raise failure alarm when temperature $\geq 94^{\circ}\text{C}$. INV control board recovers automatically when temperature $\leq 94^{\circ}\text{C}$.					
4. Possible causes					
<ul style="list-style-type: none"> ◆ The module is insecurely fixed, which results in poor heat dissipation; ◆ The radiator sensor is broken which results in high detection temperature; ◆ The cooling fan fails to operate; ◆ There is no 220V output from the terminal of cooling fan of PCB. 					

Failure code Outdoor digital display tube: 112-4, 5 Indoor wired controller: 70	Indoor unit LED status	LED5		Failure description: Fan motor module radiator temp. too high
	Outdoor unit LED status	20 times		
		LED1	LED2	
		Normal	Normal	
1. Model	Failure diagnosis and troubleshooting			
MRV 5 series	Diagnosis	Troubleshooting		
2. Abnormity detection method	<pre> graph TD A{Check if outdoor fan can rotate} -- N --> B[Check whether the outdoor fan stuck, damaged, adjust the replace fan] A -- Y --> C{Check if the fan rotation is smooth} C -- N --> D[Check the fan blocked reason] C -- Y --> E{When 112 fault occurs, whether the motor at high speed} E -- N --> F[Replace fan motor] E -- Y --> G([The motor is overloaded and check the reason]) </pre>			
3. Abnormity confirmation conditions				
Motor built-in IGBT bottom radiator temperature reaches 95.65 degree;				
4. Possible causes				
◆ Check if the radiating of the fan motor aluminum radiator is good ◆ Check if the fan is good				
◆ Motor built-in IGBT radiating poor; ◆ Outdoor fan does not turn or stuck				

Failure code Outdoor digital display tube: 114-0,1 Indoor wired controller: 72	Indoor unit LED status	LED5		Failure description: Compressor module DC BUS under voltage
		20 times		
	Outdoor unit LED status	LED1	LED2	
Normal		Normal		
1. Model	Failure diagnosis and troubleshooting			
MRV 5 series	Diagnosis		Troubleshooting	
2. Abnormity detection method	<pre> graph TD A{Check if the supply voltage is normal and the cabinet is wired correctly.} -- N --> B[Adjust the supply voltage or rewire the cabinet in accordance with circuit diagram.] A -- Y --> C{Check if the power relay and PTC is contacted.} C -- N --> D[Adjust or replace the power relay.] C -- Y --> E{Test if the voltage of DC bus is below 420V.} E -- Y --> F[The detection circuit of variable frequency board is damaged, replace the board.] E -- N --> G[Replace and compare the neighboring electrical cabinet by troubleshooting.] </pre>			
3. Abnormity confirmation conditions				
Raise failure alarm when power voltage < DC420V. INV control board recovers automatically when voltage > DC420V				
4. Possible causes				
<ul style="list-style-type: none"> ◆ Incorrect wiring may result in under voltage alarm; ◆ PTC or relay damage may result in under voltage; ◆ Low power voltage may result in under voltage. 				

Failure code Outdoor digital display tube: 114-4, 5 Indoor wired controller: 72	Indoor unit LED status	LED5		Failure description: Fan motor module DC BUS under voltage
	Outdoor unit LED status	20 times		
		LED1	LED2	
		Normal	Normal	
1. Model	Failure diagnosis and troubleshooting			
MRV 5 series	Diagnosis	Troubleshooting		
2. Abnormity detection method	<pre> graph TD A{Check if the supply voltage is normal and the cabinet is wired correctly.} -- N --> B[Adjust the supply voltage or rewire the cabinet in accordance with circuit diagram.] A -- Y --> C{Check if the PTC and SCR is damaged.} C -- N --> D[Replace the compressor module] C -- Y --> E{When the fan running, testing the DC voltage between DC + (red line), DC- (white line) if it less than 283?} E -- Y --> F[Replace the fan motor] E -- N --> G[Check the rectifier bridge, reactor, electrolytic capacitor of inverter main circuit] </pre>			
3. Abnormity confirmation conditions				
When the power voltage <DC283V, fault and alarm. Voltage> DC283V, the motor built-in control panel automatically restored				
4. Possible causes				
◆ Incorrect wiring may result in under voltage alarm; ◆ PTC or SCR damage may result in under voltage; ◆ Low power voltage may result in under voltage.				

Failure code Outdoor digital display tube: 115-0, 1 Indoor wired controller: 73	Indoor unit LED status	LED5		Failure description: Compressor module DC BUS over voltage
	Outdoor unit LED status	20 times		
		LED1	LED2	
		Normal	Normal	
1. Model	Failure diagnosis and troubleshooting			
MRV 5 series	Diagnosis	Troubleshooting		
2. Abnormity detection method	<pre> graph TD A{Check if the supply voltage is normal.} -- N --> B[Adjust the supply voltage.] A -- Y --> C{Check if the cabinet is wired correctly.} C -- N --> D[Rewire the cabinet in accordance with wiring diagram.] C -- Y --> E{Test if the voltage of DC bus is above 642V.} E -- Y --> F[The detection circuit of variable frequency board is damaged. Replace the board.] E -- N --> G[Replace and compare the neighboring electrical cabinet by troubleshooting.] </pre>			
3. Abnormity confirmation conditions				
Raise failure alarm when power voltage > DC642V. INV control board recovers automatically when voltage < DC642V.				
4. Possible causes				
◆ Incorrect connection may result in over voltage alarm; ◆ High power voltage may result in over voltage.				

Failure code Outdoor digital display tube: 117-0, 1 Indoor wired controller: 75	Indoor unit LED status	LED5		Failure description: Compressor module software over current
		20 times		
	Outdoor unit LED status	LED1	LED2	
Normal		Normal		
1. Model	Failure diagnosis and troubleshooting			
MRV 5 series	Diagnosis	Troubleshooting		
2. Abnormity detection method	<pre> graph TD A{Check if the supply voltage is normal.} -- N --> B[Adjust the supply voltage.] A -- Y --> C{Check if the electrical cabinet is wired correctly, the compressor matches U, V and W correctly and the variable frequency board and module board is connected securely.} C -- N --> D[Readjust wiring and fixing method in accordance with the circuit diagram.] C -- Y --> E{Check if the power module is normal.} E -- N --> F[Replace the power module.] E -- Y --> G{Check if the detection circuit of variable frequency board is normal.} G -- N --> H[Replace the variable frequency board.] G -- Y --> I{Check if the winding and insulation of compressor is normal.} I -- N --> J[Replace the compressor.] I -- Y --> K[Replace and compare the neighboring electrical cabinet by exclusion method] </pre>			
3. Abnormity confirmation conditions				
Over current of module software				
4. Possible causes				
<ul style="list-style-type: none"> ◆ Check if the compressor is insecurely connected; ◆ Check the system for liquid shock. ◆ Check if the module is in normal conditions and subject to short circuit. ◆ Check if the compressor is well. ◆ Check if the compressor wiring UVW is connected correctly and the inverter board and module board is securely wired. 				
<ul style="list-style-type: none"> ◆ The current detection loop of inverter board is in poor performance, which results in rapid current rise of compressor; ◆ Damage or liquid shock is found in compressor, which results in over current; ◆ UVW wiring is wrongly connected or the inverter board and module board are wired insecurely. 				

Failure code Outdoor digital display tube: 117- 4, 5 Indoor wired controller: 75	Indoor unit LED status		LED5		Failure description: Fan motor module software over current
	Outdoor unit LED status		20 times		
			LED1	LED2	
	Normal	Normal			
1. Model	Failure diagnosis and troubleshooting				
MRV 5 series	Diagnosis		Troubleshooting		
2. Abnormity detection method	<p>◆ Check if the fan motor strong electricity wire is insecurely connected; ◆ Fan rotation is smooth ◆ Check if the module is normal, if short circuit</p>				
3. Abnormity confirmation conditions	<p>Double fan: fan running current value over 5.5A, single fan: fan running current value over 6A</p>				
4. Possible causes	<p>◆ Fan motor is poor ◆ Fan blade overload</p>				
<pre> graph TD A{Check if the supply voltage is normal.} -- N --> B[Adjust the supply voltage.] A -- Y --> C{Check if the electrical cabinet is wired correctly, the variable frequency board and module board is connected securely.} C -- N --> D[Readjust wiring and fixing method in accordance with the circuit diagram.] C -- Y --> E{Motor rotation is smooth, the sound is normal} E -- N --> F[Replace the fan motor] E -- Y --> G{Running current value is normal} G -- N --> H[Replace the fan motor] G -- Y --> I[Replace and compare the neighboring electrical cabinet by exclusion method] </pre>					

Failure code Outdoor digital display tube: 119-0, 1 Indoor wired controller77	Indoor unit LED status	LED5		Failure description: Current detecting circuit abnormal of compressor module
		20 times		
	Outdoor unit LED status	LED1	LED2	
		Normal	Normal	
1. Model	Failure diagnosis and troubleshooting			
MRV 5 series	Diagnosis	Troubleshooting		
2. Abnormity detection method	<pre> graph TD D1{Check if the inverter module is connected to the three phase lines, U (red), V (white) and W (black) correspondingly on compressor?} D2{Check if the current sensor detects the current of U phase and W phase?} D3{Check if the screen printed arrow on current sensor points to the compressor?} D4{Check if the harness terminal of current sensor is connected correspondingly to the inverter controlling board? Is the connection reliable?} D5{After power on and before operation, test the DC voltage between the second pin (black, earth wire) and third pin (brown, signal wire) of the wiring harness terminal of the two current sensors, confirm if the signal voltage is within 3V±0.2V?} D1 -- Y --> D2 D1 -- N --> T1[Correct the connection in accordance with the wiring diagram and ensure negative phase and phase loss are not found.] D2 -- Y --> D3 D2 -- N --> T2[Correct the connection in accordance with the wiring diagram.] D3 -- Y --> D4 D3 -- N --> T3[Correct the connection in accordance with the wiring diagram.] D4 -- Y --> D5 D4 -- N --> T4[Correct the connection in accordance with the wiring diagram.] D5 -- Y --> End(()) D5 -- N --> T5[Replace the current sensor with abnormal signal voltage.] </pre>			
3. Abnormity confirmation conditions				
4. Possible causes				
<ul style="list-style-type: none"> ◆ Check if the current sensor is reversely connected and U and W is in reverse direction. ◆ Check if the current sensor is in reverse direction. (the arrow on sensor points at the compressor) ◆ Check if the inverter board is well. ◆ Check if the current sensor is well. 				
<p>The current detection sensor of inverter control board is in abnormal conditions, disconnected or connected incorrectly.</p>				
<ul style="list-style-type: none"> ◆ The inverter board and current sensor is anti-connected or the current sensor is in incorrect direction. ◆ The inverter board or current sensor is damaged. 				

To be continued

Continued

Failure code Outdoor digital display tube: 119-0, 1 Indoor wired controller77	Indoor unit LED status		LED5		Failure description: Current detecting circuit abnormal of compressor module
	Outdoor unit LED status		20 times		
			LED1	LED2	
		Normal	Normal		
1. Model	Failure diagnosis and troubleshooting				
MRV 5 series	Diagnosis			Troubleshooting	
2. Abnormity detection method	<pre> graph TD D1{Check if there is audible sound when the compressor starts before the 119 failure alarm. (Note: the duration is about 1s.)} D2{After power supply and upon compressor start, test the DC voltage between the second pin (black, earth wire) and third pin (brown, signal wire) of the wiring harness terminal of the two current sensors, confirm if the signal voltage is between 1V and 5V?} D3{Confirm if the wiring harness between inverter control board CN10 and module driver board CNDR15V1 is reliably connected?} D4{Confirm if the wiring harness between inverter control board CN9 and module driver board CNDR1 is reliably connected?} D1 -- N --> T1[Replace the inverter control board with abnormal current detection loop.] D1 -- Y --> D2 D2 -- N --> T2[Replace the current sensor with abnormal signal voltage.] D2 -- Y --> D3 D3 -- N --> T3[Correct the wrong connection.] D3 -- Y --> D4 D4 -- N --> T4[Correct the wrong connection.] D4 -- Y --> End[] style End fill:none,stroke:none </pre>				
3. Abnormity confirmation conditions					
4. Possible causes					
<ul style="list-style-type: none"> ◆ Check if the current sensor is reversely connected and U and W is in reverse direction. ◆ Check if the current sensor is in reverse direction. (the arrow on sensor points at the compressor) ◆ Check if the inverter board is well. ◆ Check if the current sensor is well. <p>The current detection sensor of inverter control board is in abnormal conditions, disconnected or connected incorrectly.</p> <ul style="list-style-type: none"> ◆ The inverter board and current sensor is anti-connected or the current sensor is in incorrect direction. ◆ The inverter board or current sensor is damaged. 					

To be continued

Continued

Failure code Outdoor digital display tube: 119-0, 1 Indoor wired controller77	Indoor unit LED status	LED5		Failure description: Current detecting circuit abnormal of compressor module
		20 times		
	Outdoor unit LED status	LED1	LED2	
Normal		Normal		
1. Model	Failure diagnosis and troubleshooting			
MRV 5 series	Diagnosis		Troubleshooting	
2. Abnormity detection method	<pre> graph TD D1{Replace the corresponding control boards on failure unit with inverter control board and module driver board respectively and check if the control board is in abnormal?} D2{Replace the compressor on the failure unit to drive with compressor in good performance and check if the compressor is abnormal?} A1[Replace the abnormal inverter control board or module driver board.] A2[Replace the abnormal compressor.] D1 -- Y --> A1 D1 -- N --> D2 D2 -- Y --> A2 </pre>			
3. Abnormity confirmation conditions				
The current detection sensor of inverter control board is in abnormal conditions, disconnected or connected incorrectly.				
4. Possible causes				
<ul style="list-style-type: none"> ◆ The inverter board and current sensor is anti-connected or the current sensor is in incorrect direction. ◆ The inverter board or current sensor is damaged. 				

Failure code Outdoor digital display tube: 120-0, 1 121-0, 1 Indoor wired controller: 78, 79	Indoor unit LED status	LED5		Failure description: Compressor module power supply abnormal
	Outdoor unit LED status	20 times		
		LED1	LED2	
		Normal	Normal	
1. Model	Failure diagnosis and troubleshooting			
MRV 5 series	Diagnosis	Troubleshooting		
2. Abnormity detection method	<pre> graph TD A{Check if the supply voltage is normal} -- N --> B[Adjust the power supply.] A -- Y --> C{Check if the electrical cabinet is correctly connected} C -- N --> D[Reconnect or re-fix it in accordance with circuit diagram.] C -- Y --> E{Check if the PTC or relay is contacted} E -- N --> F[Adjust or replace PTC or relay.] E -- Y --> G{Check if the voltage between P and N is less than 375V.} G -- N --> H[The DC bus voltage of variable frequency board is abnormal, replace the board.] G -- Y --> I[Check the rectifier bridge, electrolytic capacitor, electric reactor in variable frequency loop.] </pre>			
3. Abnormity confirmation conditions	The power supply of inverter control board is interrupted instantly.			
4. Possible causes	<ul style="list-style-type: none"> ◆ The supply voltage is found with abnormal fluctuations. ◆ The PTC or relay does not contact. ◆ The inverter control board is in poor performance. 			

Failure code Outdoor digital display tube: 122-0, 1 Indoor wired controller: 7A	Indoor unit LED status		LED5		Failure description: Radiator temp. sensor of compressor module is abnormal.
	Outdoor unit LED status		20 times		
			LED1	LED2	
			Normal	Normal	
1. Model	Failure diagnosis and troubleshooting				
MRV 5 series	Diagnosis			Troubleshooting	
2. Abnormity detection method	<pre> graph TD A{Check if the sensor and variable frequency board is connected correctly.} -- N --> B[Adjust the connection between temperature sensor and variable frequency board.] A -- Y --> C{Check if the sensor resistance is normal.} C -- N --> D[Replace the sensor.] C -- Y --> E[Replace the variable frequency board.] </pre>				
3. Abnormity confirmation conditions					
The temperature sensor is disconnected or the resistance is incorrect.					
4. Possible causes					
<ul style="list-style-type: none"> ◆ The resistance of temperature sensor is found with drift. ◆ The inverter board acquires inaccurate temperature. 					

Failure code Outdoor digital display tube: 123-0, 1 Indoor wired controller: 78, 7B	Indoor unit LED status	LED5		Failure description: Hardware instantaneous over current of the compressor module rectifier side
		20 times		
	Outdoor unit LED status	LED1	LED2	
Normal		Normal		
1. Model	Failure diagnosis and troubleshooting			
MRV 5 series	Diagnosis	Troubleshooting		
2. Abnormity detection method	<pre> graph TD A{Check if the supply voltage is normal} -- N --> B[Adjust the power supply.] A -- Y --> C{Check if the electrical box connect correctly, compressor wires connect reliably} C -- N --> D[Reconnect or re-fix it in accordance with circuit diagram.] C -- Y --> E{Check if the inverter module is normal} E -- N --> F[Replace the inverter module] E -- Y --> G{If the resistance, insulation of the compressor is normal} G -- N --> H[Replace the compressor] G -- Y --> I{If there are other failures 112,114} I -- Y --> J[Solve the failure] </pre>			
<ul style="list-style-type: none"> ◆ Check the module is normal, there is short circuit between P, N, U, V, W ◆ Check whether the module is fixed reliably and radiating is good; ◆ Check the compressor resistance is normal, ◆ Check if the wiring of compressor UVW is correct, frequency converter board and module board connection is reliable. 				
3. Abnormity confirmation conditions	Hardware instantaneous over current of the module rectifier side			
4. Possible causes	<ul style="list-style-type: none"> ◆ Poor radiating caused the module burned; ◆ The module is punctured to cause a breakdown; ◆ Compressor winding resistance too large ◆ UVW wiring short circuit, or compressor line short circuit to ground ◆ The compressor has a liquid shock, causing starting current or operating current too high 			

Failure code Outdoor digital display tube: 124-0, 1 Indoor wired controller: 78, 7C	Indoor unit LED status		LED5		Failure description: Compressor module three-phase power failure
	Outdoor unit LED status		20 times		
			LED1	LED2	
			Normal	Normal	
1. Model	Failure diagnosis and troubleshooting				
MRV 5 series	Diagnosis		Troubleshooting		
2. Abnormity detection method	<pre> graph TD D1{Check if the power supply voltage too low or lack of phase} D2{Check if the electrical box connect correctly} D3{Check if the inverter module connect well} D4{Check if the inverter module is normal} A1[Adjust the power supply.] A2[Reconnect or re-fix it in accordance with wiring diagram.] A3[Reconnect or re-fix it in accordance with wiring diagram.] A4[Replace the inverter module] A5[Replace the electrical box to compare] D1 -- N --> A1 D1 -- Y --> D2 D2 -- N --> A2 D2 -- Y --> D3 D3 -- N --> A3 D3 -- Y --> D4 D4 -- N --> A4 D4 -- Y --> A5 </pre>				
3. Abnormity confirmation conditions					
Module three-phase power failure					
4. Possible causes					
<ul style="list-style-type: none"> ◆ Check if the modules' R, S, T are correct, if missing phase ◆ Check if the power supply of the electrical box lack of phase, if the voltage is too low 					
<ul style="list-style-type: none"> ◆ Module three-phase voltage is too low ◆ Module three-phase power lack of phase or imbalance 					

Failure code Outdoor digital display tube: 125-0, 1 Indoor wired controller: 7D	Indoor unit LED status	LED5		Failure description: Compressor frequency un-match
	Outdoor unit LED status	20 times		
		LED1	LED2	
		Normal	Normal	
1. Model	Failure diagnosis and troubleshooting			
MRV 5 series	Diagnosis	Troubleshooting		
2. Abnormity detection method	<pre> graph TD D1{Whether the power supply voltage is too low or fluctuating significantly} D2{Check if the electrical box connect correctly} D3{Check if the inverter module is normal} D4{Compressor winding resistance, insulation is normal} D1 -- N --> T1[Adjust the power supply.] D1 -- Y --> D2 D2 -- N --> T2[Reconnect or re-fix it in accordance with wiring diagram.] D2 -- Y --> D3 D3 -- N --> T3[Replace the inverter module] D3 -- Y --> D4 D4 -- N --> T4[Replace the compressor] </pre>			
3. Abnormity confirmation conditions	(current frequency \geq INV target frequency +3Hz) or (target frequency ≥ 0 && actual frequency =0) for continuous 5 minutes			
4. Possible causes	<ul style="list-style-type: none"> ◆ The power module and inverter board are connected loosely, which results in detection failure of compressor rotation speed. ◆ The power module is damaged. 			

Failure code Outdoor digital display tube: 125-4, 5 Indoor wired controller: 7D	Indoor unit LED status	LED5		Failure description: Fan motor speed un-match
		20 times		
	Outdoor unit LED status	LED1	LED2	
		Normal	Normal	
1. Model	Failure diagnosis and troubleshooting			
MRV 5 series	Diagnosis	Troubleshooting		
2. Abnormity detection method	<pre> graph TD D1{Whether the power supply voltage is too low or fluctuating significantly} D2{Check if the electrical box connect correctly} D3{Check if the inverter module is normal} D4{Exchange the left and the right fan motor, if the failure fan motor is OK} D1 -- N --> T1[Adjust the power supply.] D1 -- Y --> D2 D2 -- N --> T2[Reconnect or re-fix it in accordance with wiring diagram.] D2 -- Y --> D3 D3 -- N --> T3[Replace the inverter module] D3 -- Y --> D4 D4 -- N --> T4[Replace fan motor] style D1 fill:#fff,stroke:#000 style D2 fill:#fff,stroke:#000 style D3 fill:#fff,stroke:#000 style D4 fill:#fff,stroke:#000 </pre>			
3. Abnormity confirmation conditions				
Hall signal logic built-in the fan motor is wrong too many times				
4. Possible causes				
<ul style="list-style-type: none"> ◆ Fan blade overload ◆ Fan motor is bad 				

23.2 Lack of refrigerant judgment method

- (1) Refer to the R410A system static balance pressure reference value form
- (2) Check if the temp. difference between coil pipe and ambient temp. less than 4°C, if yes, it means the system lack of refrigerant.

R410A system static balance pressure reference value			
Outdoor ambient temp. (°C)	Pressure (MPa)	Outdoor ambient temp. (°C)	Pressure (MPa)
-23	0.258	16	1.198
-22	0.272	17	1.235
-21	0.287	18	1.273
-20	0.301	19	1.312
-19	0.317	20	1.352
-18	0.332	21	1.392
-17	0.349	22	1.433
-16	0.365	23	1.475
-15	0.383	24	1.518
-14	0.4	25	1.562
-13	0.419	26	1.607
-12	0.437	27	1.653
-11	0.456	28	1.699
-10	0.476	29	1.747
-9	0.496	30	1.795
-8	0.517	31	1.845
-7	0.538	32	1.895
-6	0.56	33	1.946
-5	0.582	34	1.999
-4	0.605	35	2.052
-3	0.629	36	2.106
-2	0.653	37	2.162
-1	0.677	38	2.218
0	0.703	39	2.276
1	0.729	40	2.334
2	0.755	41	2.394
3	0.782	42	2.455
4	0.81	43	2.516
5	0.839	44	2.579
6	0.868	45	2.643
7	0.898	46	2.709
8	0.928	47	2.775
9	0.959	48	2.843
10	0.991	49	2.911
11	1.024	50	2.981
12	1.057	51	3.053
13	1.091	52	3.125
14	1.126	53	3.199
15	1.162		

23.3 The checking method for the valve

1. After the valve is energized, listen to the sound of valve action, if no action enter the next checking.

For the solenoid valve: check if the PCB terminal has 220V output, if yes, change the solenoid valve coil, if not OK, change the solenoid valve body.

For the electronic expansion valve: measure the resistance value.

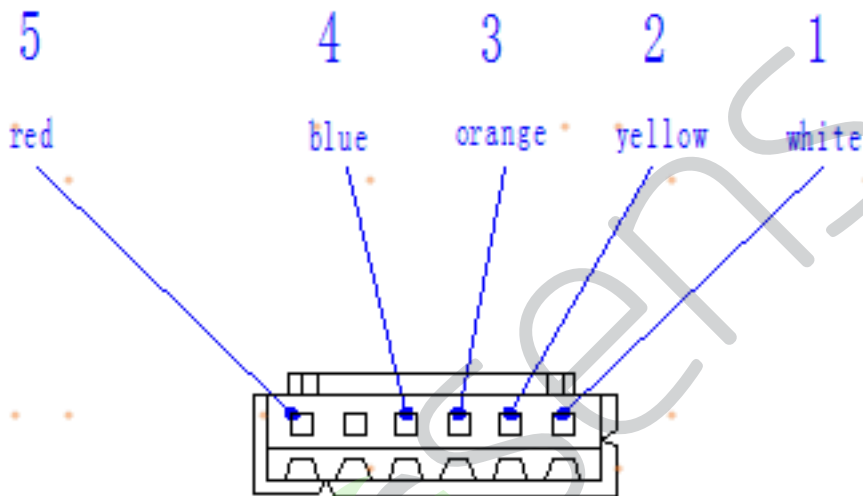

FUJIKOKI electronic expansion valve

Resistance value:

1 and 5: $46 \pm 4 \Omega$

3 and 5: $46 \pm 4 \Omega$

1 and 3: $92 \pm 8 \Omega$

2 and 4: $92 \pm 8 \Omega$

23.4 The 4-way valve reversing condition

After 4-Way valve powered on 3 minutes, if it satisfy one of the following condition lasting 10 seconds.

Condition:

-- $T_{suc} - T_{def} \geq 10^\circ C$

-- $P_d - P_s \geq \beta MP$ ($T_{ao} > -10^\circ C$, $\beta = 0.60$; $T_{ao} \leq -10^\circ C$, $\beta = 0.4$)

23.5 Fan motor detection standard

Fan motor code: 0150401918					
Expected readings of control PWB VDC outputs to DCFM			Expected readings of DC fan motor circuit board resistances		
Multi meter test points for VDC			Multi meter test points for Ω		
Multimeter red probe	Multimeter black probe	PCB DC volts	Multimeter black probe	Multimeter red probe	DCFM PWB resistance value
SE	GND2	5V	SE	GND2	0.664M Ω
+5V	GND2	5V	+5V	GND2	∞
A2	GND2	5V	A2	GND2	∞
Wiring of DC fan motor					
1	GND2	Communication signal public ground	Blue		
2	SE	Send or receive signal wire	Gray		
3	+5V	5V communication power supply	Yellow		
4	/	/	/		
5	A2	Communication address	White		
Expected readings of control PWB VDC outputs to DCFM			Expected readings of DC fan motor circuit board resistances		
Multi meter test points for VDC			Multi meter test points for Ω		
Multimeter red probe	Multimeter black probe	PCB DC volts	Multimeter black probe	Multimeter red probe	DCFM PWB resistance value
+540VDC	GND	540V	+540VDC	GND	1.444M Ω
15V	GND2	15V	15V	GND2	102.6K Ω
Wiring of DC fan motor					
1	+540VDC	Input DC high voltage positive	Red		
2	GND	Input DC high voltage negative	White		
3	GND2	Input DC 15 voltage negative	Brown		
4	15V	Input DC 15 voltage positive	Orange		

Fan motor code: 0150401919

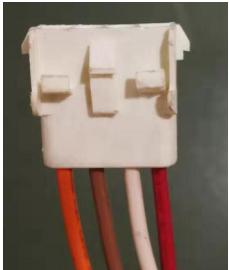
Fan motor code: 0150401919					
Expected readings of control PWB VDC outputs to DCFM			Expected readings of DC fan motor circuit board resistances		
Multi meter test points for VDC			Multi meter test points for Ω		
Multimeter red probe	Multimeter black probe	PCB DC volts	Multimeter black probe	Multimeter red probe	DCFM PWB resistance value
SE	GND2	5V	SE	GND2	0.662M Ω
+5V	GND2	5V	+5V	GND2	∞
A2	GND2	5V	A2	GND2	∞
Wiring of DC fan motor					
1	GND2	Communication signal public ground	Blue		
2	SE	Send or receive signal wire	Gray		
3	+5V	5V communication power supply	Yellow		
4	/	/	/		
5	/	/	/		
Expected readings of control PWB VDC outputs to DCFM			Expected readings of DC fan motor circuit board resistances		
Multi meter test points for VDC			Multi meter test points for Ω		
Multimeter red probe	Multimeter black probe	PCB DC volts	Multimeter black probe	Multimeter red probe	DCFM PWB resistance value
+540VDC	GND	540V	+540VDC	GND	1.46M Ω
15V	GND2	15V	15V	GND2	101.1K Ω
Wiring of DC fan motor					
1	+540VDC	Input DC high voltage positive	Red		
2	GND	Input DC high voltage negative	White		
3	GND2	Input DC 15 voltage negative	Brown		
4	15V	Input DC 15 voltage positive	Orange		

23.6 Power module detection standard

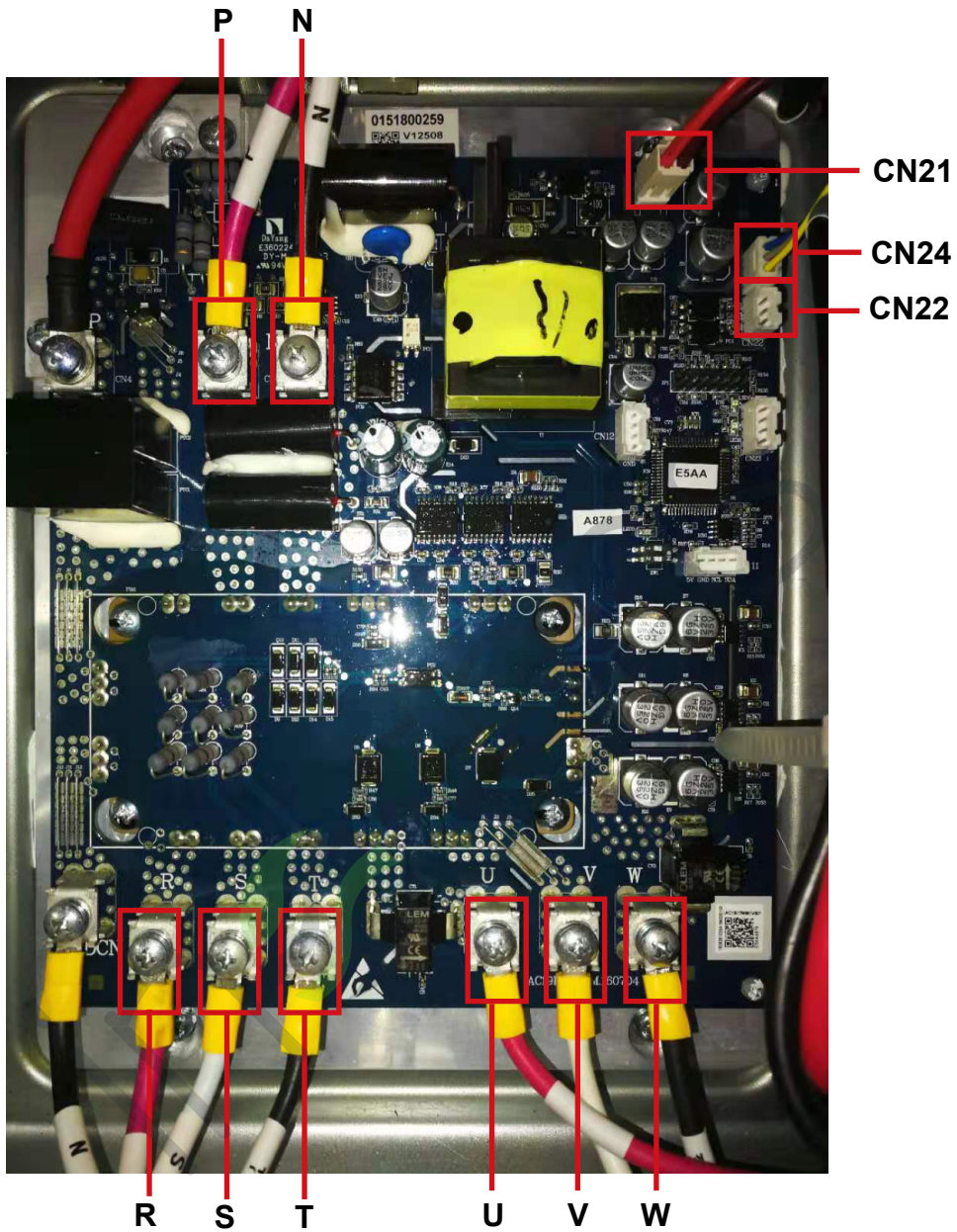

No.	Terminal name	Standard
1	CN21	DC 15V
2	CN22	DC 5V
3	CN24	DC 5V

Testing terminal	Standard
U and W	∞
U and V	∞
W and V	∞
R and S	About 1.262M Ω
R and T	About 1.535M Ω
S and T	About 1.247M Ω

Note: measure after removing the connection wires

Multimeter red prode	Multimeter black prode	Standard
P	U	About 1.411M Ω
P	V	About 1.411M Ω
P	W	About 1.411M Ω
U	N	About 1.422M Ω
V	N	About 1.422M Ω
W	N	About 1.422M Ω

Note: measure after removing the connection wires

23.7 Compressor detection standard

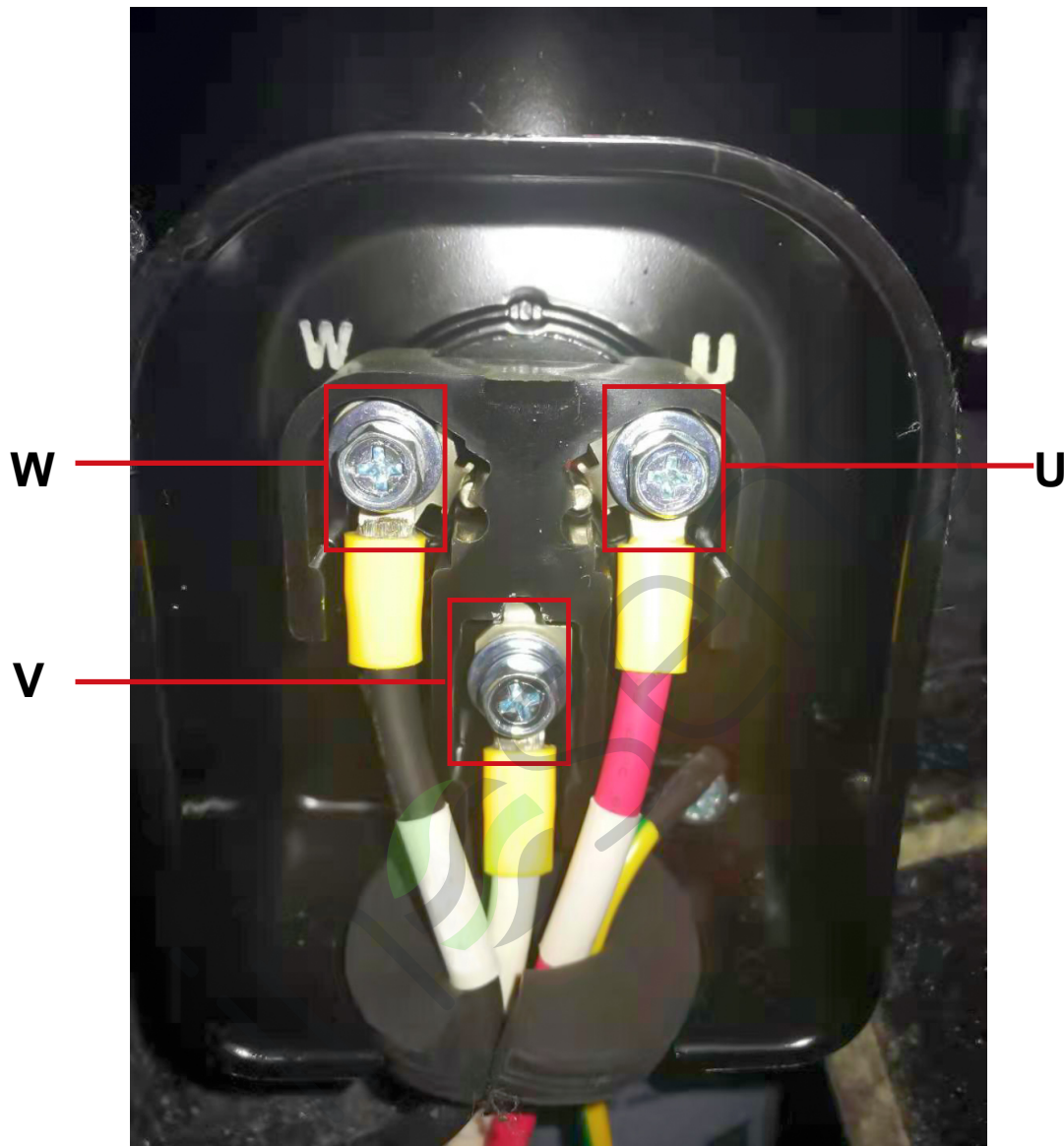

Testing terminal	Resistance value
U and W	About 300MΩ
U and V	About 300MΩ
W and V	About 300MΩ
Note: measure after removing the connection wires	

23.8 Sensor resistance table

NO.	Model	Name	Code	Characteristic
1	AV08NMVETA AV10NMVETA AV12NMVETA AV14NMVETA AV16NMVETA AV18NMVETA AV20NMVETA AV22NMVETA AV24NMVETA AV26NMVETA	Tao ambient temp. sensor	0150401910	R25=10KΩ
2		Td1 compressor 1 discharge temp. sensor	0150401914	R80=50KΩ
3		Td2 compressor 2 discharge temp. sensor	0150401915	R80=50KΩ
4		Toci1/Ts sensor	0150401911	R25=10KΩ
5		Tdef defrosting temp. sensor	0150401913	R25=10KΩ
6		Toil1 compressor 1 oil temp. sensor	0150401916	R80=50KΩ
7		Toil2 compressor 2 oil temp. sensor	0150401917	R80=50KΩ

R80=50kΩ±3% B25/80=4450K±3%					
Temp	Resistance (kΩ)			% (Resist. Tol)	
(°C)	Rmax	R (t) Normal	Rmin	MAX (+)	MIN (-)
0	1749.014	1921.993	2094.972	9	9
1	1651.431	1813.265	1975.099	8.93	8.93
2	1560.165	1711.646	1863.127	8.85	8.85
3	1474.737	1616.593	1758.449	8.78	8.78
4	1394.709	1527.611	1660.513	8.7	8.7
5	1319.683	1444.25	1568.817	8.63	8.63
6	1249.295	1366.096	1482.897	8.55	8.55
7	1183.21	1292.773	1402.336	8.48	8.48
8	1121.124	1223.935	1326.746	8.4	8.4
9	1062.756	1159.265	1255.774	8.33	8.33
10	1007.85	1098.474	1189.098	8.25	8.25
11	956.167	1041.293	1126.419	8.18	8.18
12	907.491	987.477	1067.463	8.1	8.1
13	861.621	936.799	1011.977	8.03	8.03
14	818.372	889.052	959.732	7.95	7.95
15	777.574	844.042	910.51	7.88	7.88
16	739.066	801.59	864.114	7.8	7.8
17	702.705	761.533	820.361	7.73	7.73
18	668.353	723.717	779.081	7.65	7.65
19	635.885	688.001	740.117	7.58	7.58
20	605.185	654.254	703.323	7.5	7.5
21	576.145	622.355	668.565	7.43	7.43
22	548.663	592.189	635.715	7.35	7.35
23	522.645	563.651	604.657	7.28	7.28
24	498.006	536.644	575.282	7.2	7.2
25	474.662	511.076	547.49	7.13	7.13
26	452.538	486.862	521.186	7.05	7.05
27	431.563	463.922	496.281	6.98	6.98
28	411.671	442.182	472.693	6.9	6.9
29	392.8	421.572	450.344	6.83	6.83
30	374.891	402.028	429.165	6.75	6.75
31	357.891	383.489	409.087	6.68	6.68
32	341.749	365.898	390.047	6.6	6.6
33	326.416	349.201	371.986	6.53	6.53
34	311.848	333.349	354.85	6.45	6.45
35	298.004	318.295	338.586	6.38	6.38
36	284.843	303.995	323.147	6.3	6.3

R80=50kΩ±3% B25/80=4450K±3%					
Temp	Resistance (kΩ)			% (Resist. Tol)	
(°C)	Rmax	R (t) Normal	Rmin	MAX (+)	MIN (-)
37	272.329	290.407	308.485	6.23	6.23
38	260.427	277.493	294.559	6.15	6.15
39	249.104	265.216	281.328	6.08	6.08
40	238.329	253.541	268.753	6	6
41	228.073	242.437	256.801	5.93	5.93
42	218.308	231.873	245.438	5.85	5.85
43	209.01	221.82	234.63	5.78	5.78
44	200.154	212.252	224.35	5.7	5.7
45	191.715	203.142	214.569	5.63	5.63
46	183.674	194.467	205.26	5.55	5.55
47	176.009	186.204	196.399	5.48	5.48
48	168.703	178.333	187.963	5.4	5.4
49	161.735	170.832	179.929	5.33	5.33
50	155.089	163.682	172.275	5.25	5.25
51	148.748	156.866	164.984	5.18	5.18
52	142.698	150.367	158.036	5.1	5.1
53	136.924	144.168	151.412	5.03	5.03
54	131.411	138.255	145.099	4.95	4.95
55	126.148	132.613	139.078	4.88	4.88
56	121.122	127.229	133.336	4.8	4.8
57	116.32	122.089	127.858	4.73	4.73
58	111.732	117.181	122.63	4.65	4.65
59	107.347	112.494	117.641	4.58	4.58
60	103.157	108.018	112.879	4.5	4.5
61	99.15	103.741	108.332	4.43	4.43
62	95.319	99.654	103.989	4.35	4.35
63	91.655	95.748	99.841	4.28	4.28
64	88.149	92.014	95.879	4.2	4.2
65	84.795	88.443	92.091	4.13	4.13
66	81.584	85.028	88.472	4.05	4.05
67	78.511	81.761	85.011	3.98	3.98
68	75.569	78.636	81.703	3.9	3.9
69	72.752	75.645	78.538	3.83	3.83
70	70.052	72.781	75.51	3.75	3.75
71	67.466	70.04	72.614	3.68	3.68

R80=50kΩ±3% B25/80=4450K±3%					
Temp	Resistance (kΩ)			% (Resist. Tol)	
(°C)	Rmax	R (t) Normal	Rmin	MAX (+)	MIN (-)
72	64.988	67.415	69.842	3.6	3.6
73	62.613	64.901	67.189	3.53	3.53
74	60.337	62.493	64.649	3.45	3.45
75	58.154	60.185	62.216	3.38	3.38
76	56.06	57.973	59.886	3.3	3.3
77	54.051	55.852	57.653	3.23	3.23
78	52.125	53.82	55.515	3.15	3.15
79	50.275	51.87	53.465	3.08	3.08
80	48.5	50	51.5	3	3
81	46.728	48.206	49.684	3.07	3.07
82	45.028	46.484	47.94	3.13	3.13
83	43.397	44.832	46.267	3.2	3.2
84	41.833	43.246	44.659	3.27	3.27
85	40.332	41.723	43.114	3.33	3.33
86	38.891	40.26	41.629	3.4	3.4
87	37.509	38.856	40.203	3.47	3.47
88	36.181	37.506	38.831	3.53	3.53
89	34.905	36.209	37.513	3.6	3.6
90	33.68	34.962	36.244	3.67	3.67
91	32.503	33.764	35.025	3.73	3.73
92	31.373	32.612	33.851	3.8	3.8
93	30.286	31.504	32.722	3.87	3.87
94	29.242	30.439	31.636	3.93	3.93
95	28.236	29.413	30.59	4	4
96	27.271	28.427	29.583	4.07	4.07
97	26.342	27.478	28.614	4.13	4.13
98	25.448	26.564	27.68	4.2	4.2
99	24.589	25.685	26.781	4.27	4.27
100	23.762	24.838	25.914	4.33	4.33
101	22.966	24.023	25.08	4.4	4.4
102	22.199	23.237	24.275	4.47	4.47
103	21.462	22.481	23.5	4.53	4.53
104	20.751	21.752	22.753	4.6	4.6

R80=50kΩ±3% B25/80=4450K±3%					
Temp	Resistance (kΩ)			% (Resist. Tol)	
(°C)	Rmax	R (t) Normal	Rmin	MAX (+)	MIN (-)
105	20.067	21.049	22.031	4.67	4.67
106	19.408	20.372	21.336	4.73	4.73
107	18.773	19.72	20.667	4.8	4.8
108	18.162	19.091	20.02	4.87	4.87
109	17.573	18.485	19.397	4.93	4.93
110	17.005	17.9	18.795	5	5
111	16.459	17.337	18.215	5.07	5.07
112	15.931	16.793	17.655	5.13	5.13
113	15.422	16.268	17.114	5.2	5.2
114	14.933	15.763	16.593	5.27	5.27
115	14.46	15.275	16.09	5.33	5.33
116	14.005	14.804	15.603	5.4	5.4
117	13.565	14.349	15.133	5.47	5.47
118	13.141	13.911	14.681	5.53	5.53
119	12.733	13.488	14.243	5.6	5.6
120	12.339	13.08	13.821	5.67	5.67
121	11.958	12.685	13.412	5.73	5.73
122	11.591	12.305	13.019	5.8	5.8
123	11.238	11.938	12.638	5.87	5.87
124	10.897	11.584	12.271	5.93	5.93
125	10.567	11.242	11.917	6	6
126	10.249	10.911	11.573	6.07	6.07
127	9.943	10.593	11.243	6.13	6.13
128	9.647	10.285	10.923	6.2	6.2
129	9.362	9.988	10.614	6.27	6.27
130	9.087	9.701	10.315	6.33	6.33
131	8.822	9.425	10.028	6.4	6.4
132	8.566	9.158	9.75	6.47	6.47
133	8.319	8.9	9.481	6.53	6.53
134	8.08	8.651	9.222	6.6	6.6
135	7.85	8.411	8.972	6.67	6.67
136	7.629	8.18	8.731	6.73	6.73
137	7.416	7.957	8.498	6.8	6.8
138	7.209	7.741	8.273	6.87	6.87
139	7.011	7.533	8.055	6.93	6.93
140	6.82	7.333	7.846	7	7

R25=10kΩ±3% B25/50=3700K±3%					
Temp	Resistance (kΩ)			% (Resist. Tol)	
(°C)	Rmax	R (t) Normal	Rmin	MAX (+)	MIN (-)
-30	145.819	135.018	124.217	7	7
-29	138.071	129.126	120.181	6.93	6.93
-28	131.793	123.339	114.885	6.85	6.85
-27	125.665	117.684	109.703	6.78	6.78
-26	119.706	112.18	104.654	6.71	6.71
-25	113.933	106.843	99.753	6.64	6.64
-24	108.361	101.687	95.013	6.56	6.56
-23	102.997	96.719	90.441	6.49	6.49
-22	97.847	91.946	86.045	6.42	6.42
-21	92.915	87.371	81.827	6.35	6.35
-20	88.2	82.994	77.788	6.27	6.27
-19	83.702	78.815	73.928	6.2	6.2
-18	79.417	74.832	70.247	6.13	6.13
-17	75.342	71.041	66.74	6.05	6.05
-16	71.471	67.437	63.403	5.98	5.98
-15	67.798	64.015	60.232	5.91	5.91
-14	64.316	60.769	57.222	5.84	5.84
-13	61.017	57.692	54.367	5.76	5.76
-12	57.895	54.778	51.661	5.69	5.69
-11	54.942	52.019	49.096	5.62	5.62
-10	52.149	49.409	46.669	5.55	5.55
-9	49.51	46.941	44.372	5.47	5.47
-8	47.016	44.607	42.198	5.4	5.4
-7	44.659	42.4	40.141	5.33	5.33
-6	42.433	40.315	38.197	5.25	5.25
-5	40.332	38.345	36.358	5.18	5.18
-4	38.346	36.482	34.618	5.11	5.11
-3	36.472	34.723	32.974	5.04	5.04
-2	34.7	33.059	31.418	4.96	4.96
-1	33.027	31.487	29.947	4.89	4.89
0	31.445	30	28.555	4.82	4.82
1	29.951	28.594	27.237	4.75	4.75
2	28.538	27.264	25.99	4.67	4.67
3	27.202	26.006	24.81	4.6	4.6
4	25.938	24.815	23.692	4.53	4.53

R25=10kΩ±3% B25/50=3700K±3%					
Temp	Resistance (kΩ)			% (Resist. Tol)	
(°C)	Rmax	R (t) Normal	Rmin	MAX (+)	MIN (-)
5	24.742	23.687	22.632	4.45	4.45
6	23.61	22.619	21.628	4.38	4.38
7	22.538	21.607	20.676	4.31	4.31
8	21.522	20.647	19.772	4.24	4.24
9	20.559	19.737	18.915	4.16	4.16
10	19.646	18.874	18.102	4.09	4.09
11	18.779	18.054	17.329	4.02	4.02
12	17.958	17.276	16.594	3.95	3.95
13	17.177	16.537	15.897	3.87	3.87
14	16.436	15.834	15.232	3.8	3.8
15	15.731	15.166	14.601	3.73	3.73
16	15.061	14.53	13.999	3.65	3.65
17	14.424	13.925	13.426	3.58	3.58
18	13.817	13.349	12.881	3.51	3.51
19	13.24	12.8	12.36	3.44	3.44
20	12.69	12.277	11.864	3.36	3.36
21	12.166	11.778	11.39	3.29	3.29
22	11.666	11.302	10.938	3.22	3.22
23	11.189	10.848	10.507	3.15	3.15
24	10.734	10.414	10.094	3.07	3.07
25	10.3	10	9.7	3	3
26	9.898	9.604	9.31	3.06	3.06
27	9.514	9.226	8.938	3.13	3.13
28	9.147	8.864	8.581	3.19	3.19
29	8.796	8.519	8.242	3.25	3.25
30	8.459	8.188	7.917	3.31	3.31
31	8.137	7.871	7.605	3.38	3.38
32	7.828	7.568	7.308	3.44	3.44
33	7.532	7.277	7.022	3.5	3.5
34	7.248	6.999	6.75	3.56	3.56
35	6.977	6.733	6.489	3.63	3.63
36	6.716	6.477	6.238	3.69	3.69
37	6.466	6.232	5.998	3.75	3.75
38	6.227	5.998	5.769	3.81	3.81
39	5.997	5.773	5.549	3.88	3.88
40	5.776	5.557	5.338	3.94	3.94
41	5.564	5.35	5.136	4	4

R25=10kΩ±3% B25/50=3700K±3%					
Temp	Resistance (kΩ)			% (Resist. Tol)	
(°C)	Rmax	R (t) Normal	Rmin	MAX (+)	MIN (-)
42	5.36	5.151	4.942	4.06	4.06
43	5.166	4.961	4.756	4.13	4.13
44	4.978	4.778	4.578	4.19	4.19
45	4.799	4.603	4.407	4.25	4.25
46	4.625	4.434	4.243	4.31	4.31
47	4.46	4.273	4.086	4.38	4.38
48	4.301	4.118	3.935	4.44	4.44
49	4.148	3.969	3.79	4.5	4.5
50	4.001	3.826	3.651	4.56	4.56
51	3.86	3.689	3.518	4.63	4.63
52	3.724	3.557	3.39	4.69	4.69
53	3.594	3.431	3.268	4.75	4.75
54	3.468	3.309	3.15	4.81	4.81
55	3.349	3.193	3.037	4.88	4.88
56	3.233	3.081	2.929	4.94	4.94
57	3.123	2.974	2.825	5	5
58	3.015	2.87	2.725	5.06	5.06
59	2.913	2.771	2.629	5.13	5.13
60	2.815	2.676	2.537	5.19	5.19
61	2.721	2.585	2.449	5.25	5.25
62	2.63	2.497	2.364	5.31	5.31
63	2.543	2.413	2.283	5.38	5.38
64	2.459	2.332	2.205	5.44	5.44
65	2.379	2.255	2.131	5.5	5.5
66	2.301	2.18	2.059	5.56	5.56
67	2.228	2.109	1.99	5.63	5.63
68	2.156	2.04	1.924	5.69	5.69
69	2.088	1.974	1.86	5.75	5.75
70	2.021	1.91	1.799	5.81	5.81
71	1.958	1.849	1.74	5.88	5.88
72	1.897	1.791	1.685	5.94	5.94
73	1.839	1.735	1.631	6	6
74	1.782	1.68	1.578	6.06	6.06
75	1.728	1.628	1.528	6.13	6.13

R25=10kΩ±3% B25/50=3700K±3%					
Temp	Resistance (kΩ)			% (Resist. Tol)	
(°C)	Rmax	R (t) Normal	Rmin	MAX (+)	MIN (-)
76	1.676	1.578	1.48	6.19	6.19
77	1.626	1.53	1.434	6.25	6.25
78	1.578	1.484	1.39	6.31	6.31
79	1.531	1.439	1.347	6.38	6.38
80	1.486	1.396	1.306	6.44	6.44
81	1.443	1.355	1.267	6.5	6.5
82	1.401	1.315	1.229	6.56	6.56
83	1.362	1.277	1.192	6.63	6.63
84	1.323	1.24	1.157	6.69	6.69
85	1.285	1.204	1.123	6.75	6.75
86	1.249	1.169	1.089	6.81	6.81
87	1.214	1.136	1.058	6.88	6.88
88	1.181	1.104	1.027	6.94	6.94
89	1.148	1.073	0.998	7	7
90	1.116	1.042	0.968	7.06	7.06
91	1.085	1.013	0.941	7.13	7.13
92	1.056	0.985	0.914	7.19	7.19
93	1.026	0.957	0.888	7.25	7.25
94	0.998	0.93	0.862	7.31	7.31
95	0.971	0.904	0.837	7.38	7.38
96	0.944	0.879	0.814	7.44	7.44
97	0.918	0.854	0.79	7.5	7.5
98	0.893	0.83	0.767	7.56	7.56
99	0.867	0.806	0.745	7.63	7.63
100	0.843	0.783	0.723	7.69	7.69
101	0.819	0.76	0.701	7.75	7.75
102	0.796	0.738	0.68	7.81	7.81
103	0.772	0.716	0.66	7.88	7.88
104	0.749	0.694	0.639	7.94	7.94
105	0.727	0.673	0.619	8	8

24. Parts Replacement Instructions

24.1 Compressor replacement

Take the following procedures to ensure sufficient maintenance space and good visibility.

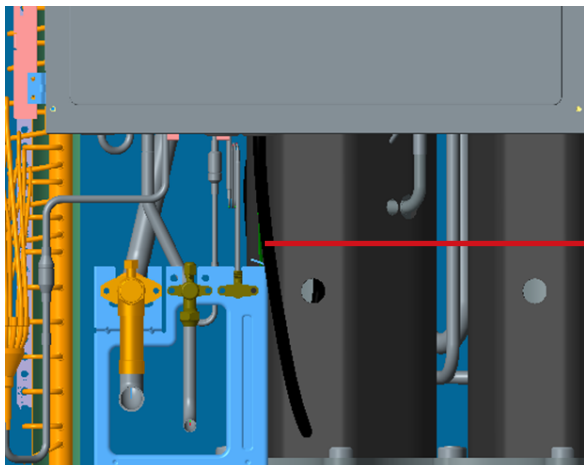

Step 1: Remove the power supply wire and grounding wire of the compressor from the electric control box.

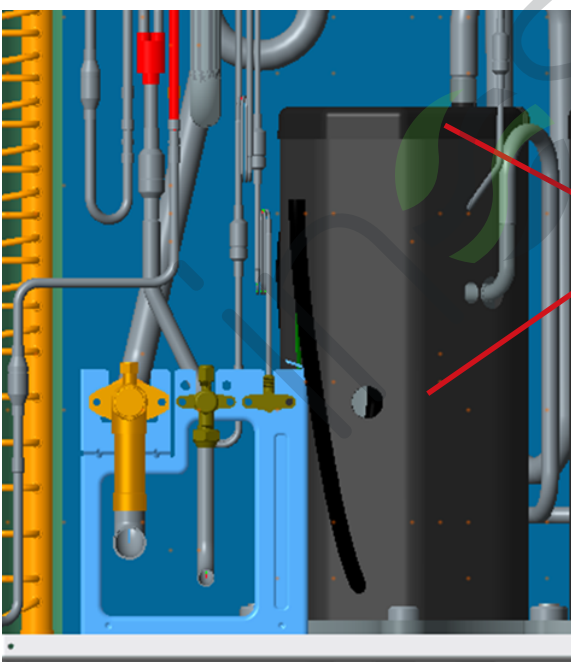

Step 2: Remove inside and outside compressor quite

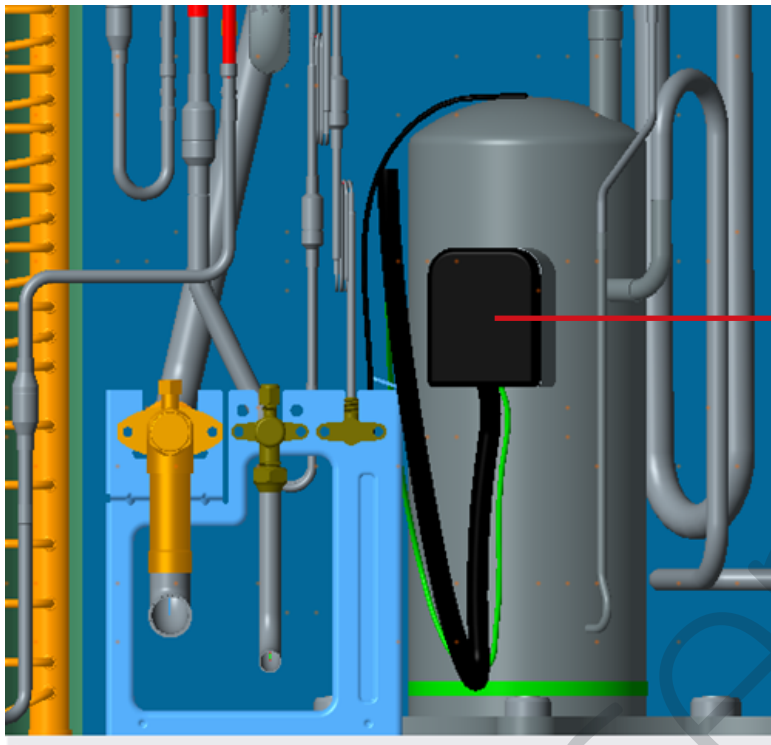

Step 3: Remove terminal box cover of compressor

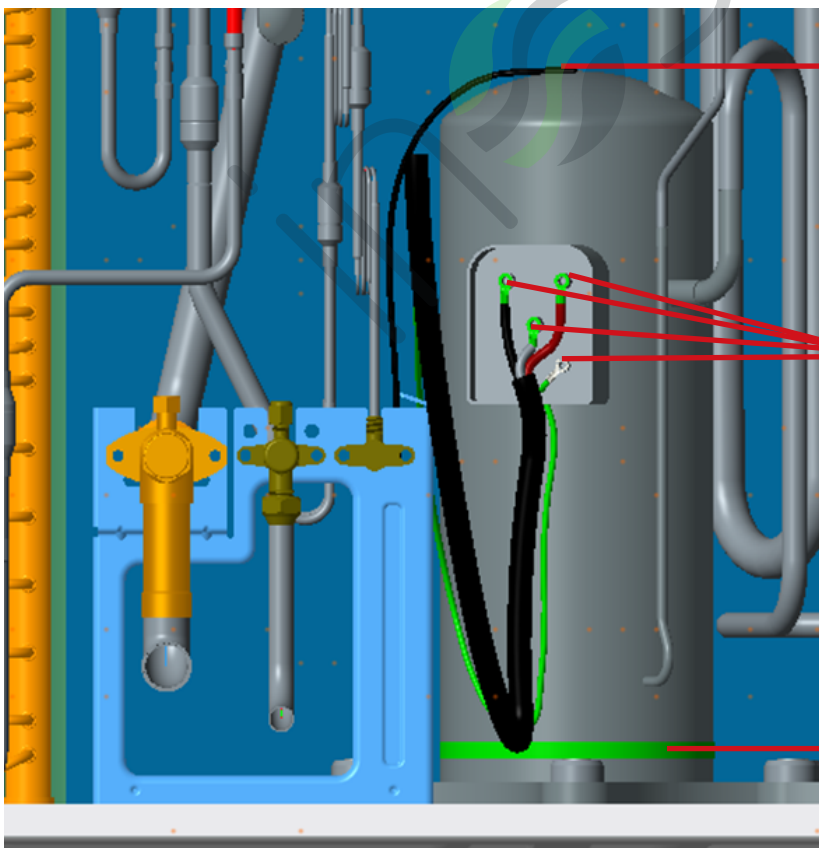

Step 4: Remove the discharge temperature sensor

Step 5: Remove the compressor wires and grounding wire by unscrewing the 4 screws

Step 6: Remove the heater and oil temperature sensor

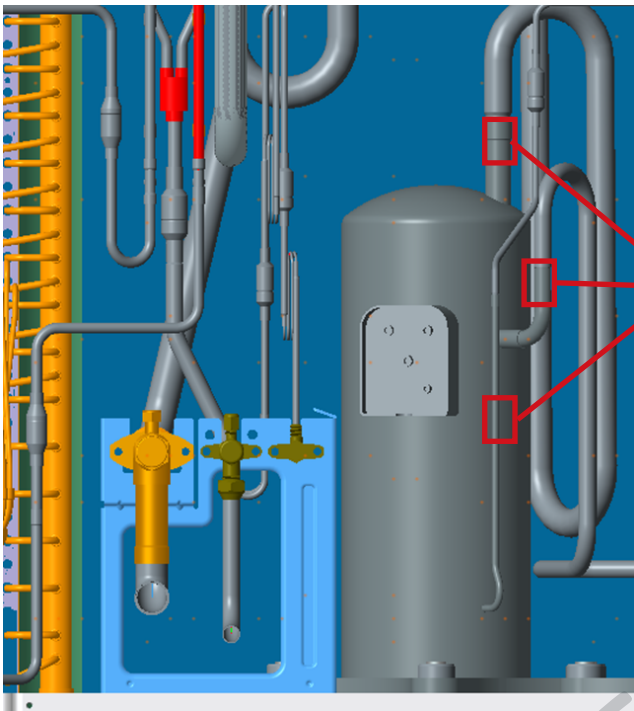

Step 7: Unsoldering the discharge pipe / suction pipe / oil return pipe with a welding torch at the marked position as shown in the picture

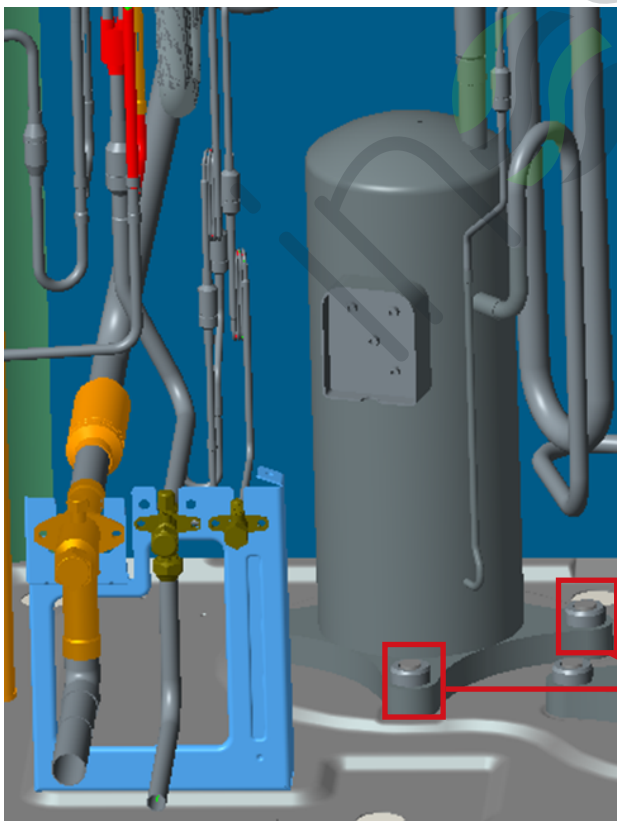

Step 8: Remove the old compressor by dismantling the 4 compressor fixing nuts

25. Smartlink

25.1 Smartlink Introduction

Smartlink is one kind of wireless communication technology, which contains Master wireless module, Slave wireless module and Repeater.

1. Master wireless module, Slave wireless module and Repeater share the same hardware but with different software program inside.
2. Repeater is powered by extra 5V power adapter



Connectable outdoor series	Model
MRV 5	AV*IMVEVA
MRV 5	AV*NMVETA
MRV 5-RC	AV*IMVURA

Connectable indoor series	Model	Remarks
4-way cassette	AB*MCERA AB*MCERA(C)	The indoor unit must be the new indoor manufactured after January 1, 2019 (the PCB is upgraded program)
Round flow 4-way cassette	AB*MRERA	
MINI 4-way cassette	AB*MCERA(M)	
2-way cassette	AB*MBERA	
One way cassette	AB*MAERA	
Convertible	AC*MCERA AC*MFERA	
DC Slim low ESP duct	AD*MSERA(D)	
Slim low ESP duct	AD*MSERA	
Low ESP duct	AD*MLERA	
Medium ESP duct	AD*MNERA	
	AD*MMERA	
	AD*MJERA	
	AD*MJERAB	
High ESP duct	AD*MHERA	
	AD*MQERA	
N plate high wall	AS*MFERA	
	AS*MNERA	
	AS*MFERAB	
	AS*MNERAB	
Console	AF*MBERA	

Connectable indoor series	Model	PCB code	PCB version	Remarks
4-way cassette	AB*MCERA AB*MCERA(C)	0151800113	V12.4	The PCB spare parts required for the wireless system and the MRV 5-RC system must also be the changed version (the version number is in the table or later than this version or the production time is after January 1, 2019)
Round flow 4-way cassette	AB*MRERA	0151800227	V6.6	
MINI 4-way cassette	AB*MCERA(M)	0151800244BA	V4.1	
2-way cassette	AB*MBERA	0151800161B	V12.4	
One way cassette	AB*MAERA	0151800244BA	V4.1	
Convertible	AC*MCERA AC*MFERA	0151800113	V6.6	
DC Slim low ESP duct	AD*MSERA(D)	0151800244	V6.6	
Slim low ESP duct	AD*MSERA	0151800161C	V11.9	
Low ESP duct	AD*MLERA	0151800113	V6.6	
Medium ESP duct	AD*MNERA	0151800113	V6.6	
	AD*MMERA	0151800113	V6.6	
	AD*MJERA	0151800161C 0151800161G	V11.9	
	AD*MJERAB	0151800161D	V11.9	
High ESP duct	AD*MHERA	0151800113	V6.6	
	AD*MQERA	0151800244 0151800227A	V6.6	
N plate high wall	AS*MFERA AS*MNERA AS*MFERAB AS*MNERAB	0151800244B	V4.1	
Console	AF*MBERA	0151800452	V0.8	

PCB production time

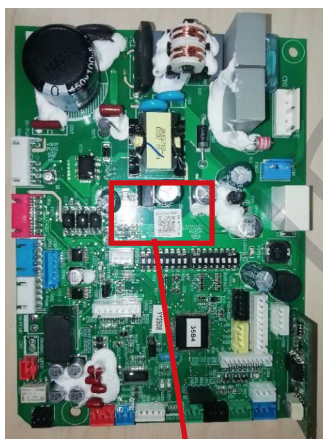

25.2 Smartlink benefits

• Easy Installation

Traditional wired connection has complex operation procedures, such as wiring, wire threading, wire binding and wire cutting etc. which cost a lot of labor and resources.

Smartlink as a wireless communication technology, make installation easier by removing the complex wire connection procedure.

• Smart networking

Traditional AC wire connection method is hand-in-hand, which is not flexible.

Smartlink realizes smart networking by dip switch operation. Besides, when the communication signal of the units changes, it can seek other strong signal path nearby and keep the stable communication of the system.

• Convenient Maintenance

Under wired connection system, communication error of one unit will cause all the units communication error which make the system stop running. It is so hard for the maintainer to find the error unit only by checking all the units in turn.

But for the system with smartlink, if one unit has communication error which will not affect other units. Because other units will change their communication path by choosing the stronger communication path to keep the system running. Therefore, it is convenient for the maintainer to maintain by focusing on the error unit.

• Stable performance.

For the system adopting wired communication, there are a lot of wire related problems such as wire aging and wire broken caused by users or animals affecting the normal use of units.

Smartlink can reduce the possibility of above problems and make performance more stable by adopting wireless communication.

• Big benefits for reconstructed projects.

For some projects need to be reconstructed, because different brands use different communication wire, it is necessary to change the wire during the reconstruction. Smartlink has a lot of benefits for such projects. Because wireless Smartlink can remove re-wiring work and will make reconstruction easier.

25.3 Smartlink specification

Item	Model	BOM No.	Spare part code	Indoor PCB connection terminal
Main IDU Wireless module	IGU09	AA9VH2B3P	0151800313C	CN34
Slave IDU Wireless Module	IGU10	AA9VH1B3P	0151800314B	CN34
Repeater	IGU11	AA9VH0B3P	0151800321B	/

25.4 Wiring figure

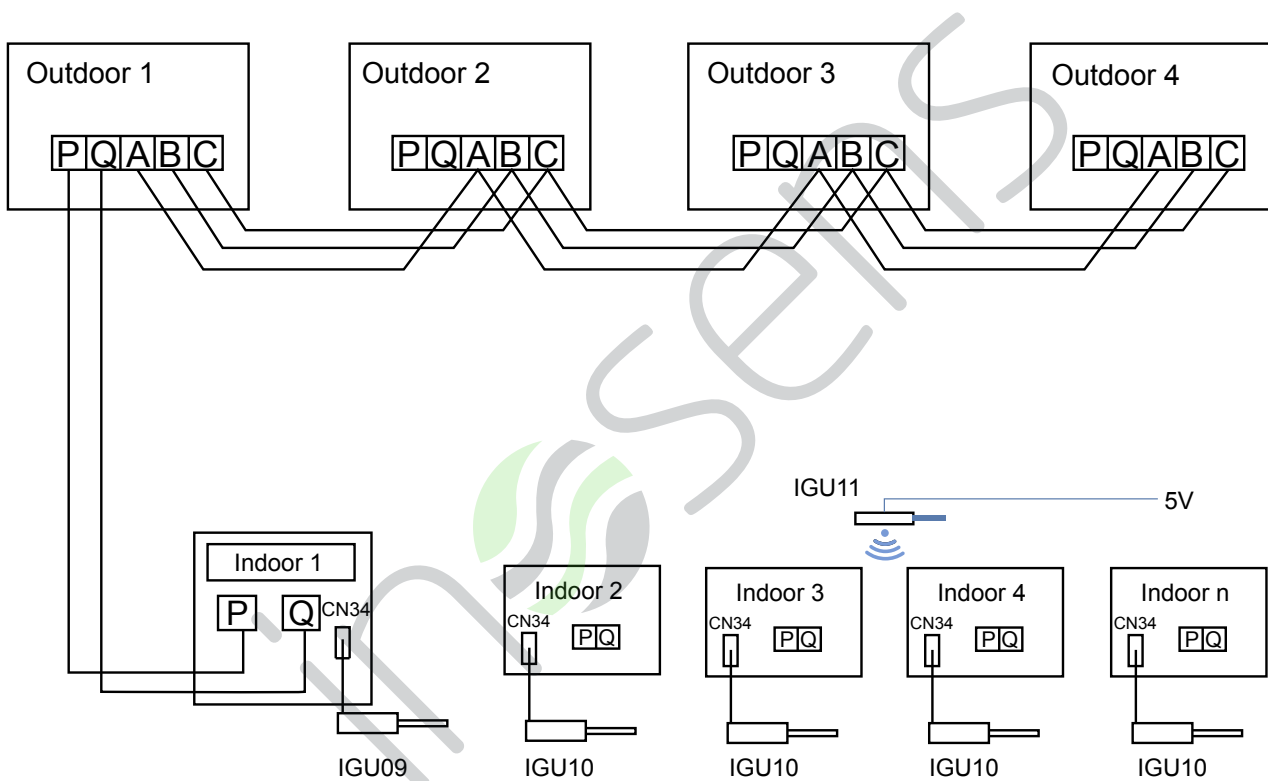

Note:

If the system unit adopts Zigbee wireless communication, it must adopt wireless and wired hybrid mode. The PQ cable must be connected to the IDU which one with the smallest address number

25.5 Dimension

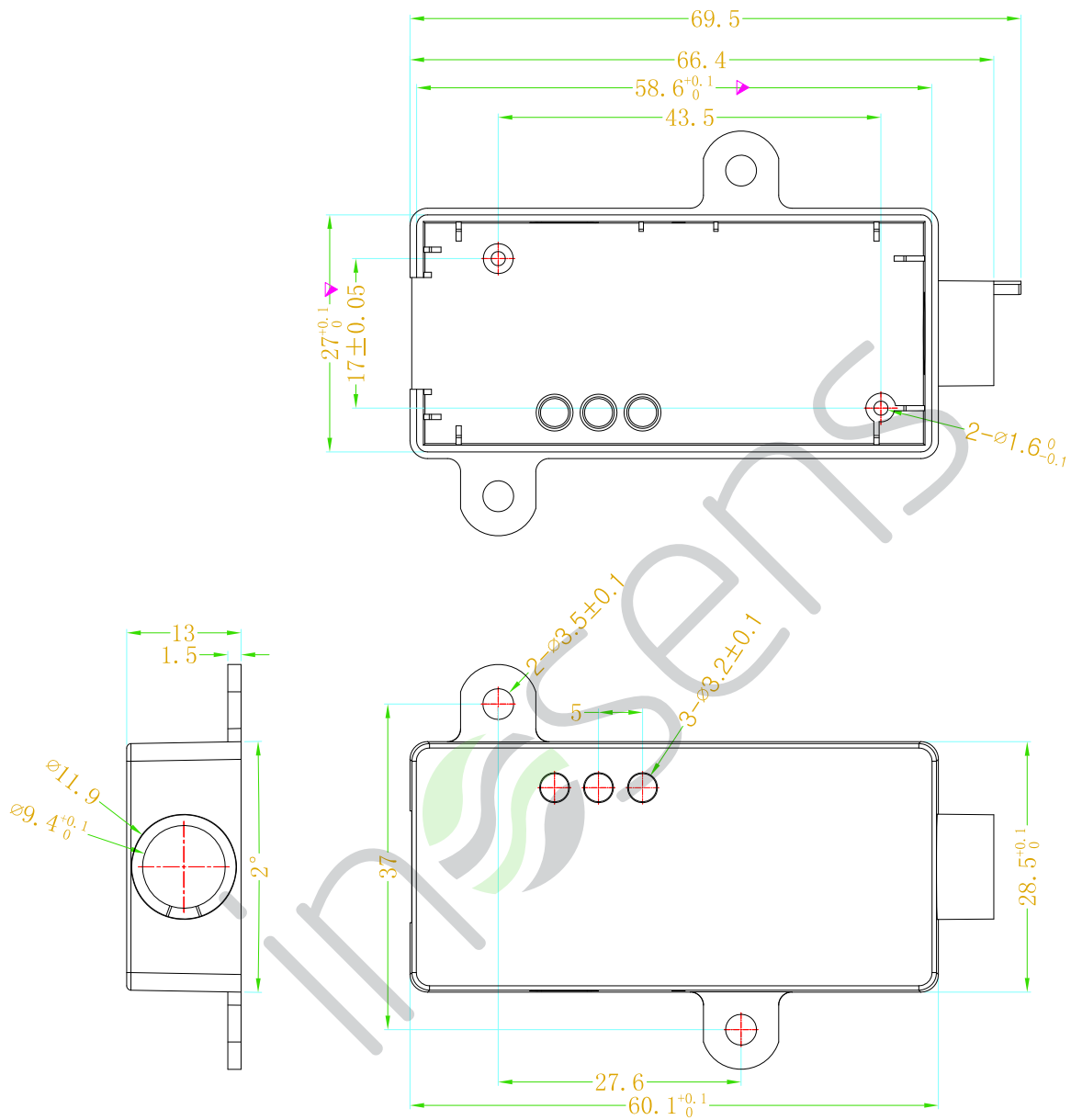

25.6 The installation requirement of Smartlink

(1). The Connection requirement of wireless communication system

For the MRV system adopting wireless communication, it is recommended to adopt the mix-connection solution of wired and wireless communication, namely the master ODU connecting with one nearest IDU by wire and all IDUs adopting wireless communication with each other within the system. The ODU does not need to be equipped with a wireless module. The first indoor unit connected to the outdoor unit is used as the main IDU. The main IDU wireless module (IGU09) needs to be installed, and the slave IDU wireless module (IGU10) are installed the other IDU. (Note: for the MRV 5-RC system, the outdoor and all the valve boxes must be connected by the wires, the indoor unit which is not connected with valve box must be connected by wires, the valve box as the main IDU, indoor units connected with valve box as the slave IDU)

(2) The installation requirement IDU wireless module

a. If IDU wireless module as standard module means its installation has been finished before delivering. If as optional module, it needs to be installed in the specific location, with communication wire connecting to CN 34 port of IDU PC board.

b. The antenna of the IDU wireless module is rotatable. Keep the antenna more than 10cm away from metals

c. Keep the IDUs with wireless module more than 10m away from the Wifi devices in the room.

(3) The installation requirement of Repeater

a. Add one repeater when the distance between any two wireless modules (both ODU wireless module and IDU wireless module) exceeds per 100m.

b. Add one repeater when there is one wall or other similar buildings between any two wireless modules, both ODU wireless module and IDU wireless module.

Remark: Do not need to add the repeater when there is only one wall between ODUs and ODUs

c. Repeater should be installed in the open space as far as possible, especially keeping the antenna more than 10cm away from metals

d. Repeater must be supplied power separately by its own power adapter. The installation of the repeater should consider the convenience of connection to external single-phase 220V AC power supply and the required waterproof position.

Remark: According to the above requirement, the number of repeaters to be installed should be calculated in advance. Adding the repeaters based on above requirements can ensure the reliability and stability of wireless communication system.

(4) The installation requirement of IDUs

a. For the system adopting wireless communication, the installation of IDUs should use network structure instead of line-type structure;

b. Do not install the IDUs in the space surrounded by metal, such as metro computer room and hospital X-ray room, otherwise the system should adopt the wired connection.

c. Keep the IDUs more than 10m away from the Wifi devices in the room.

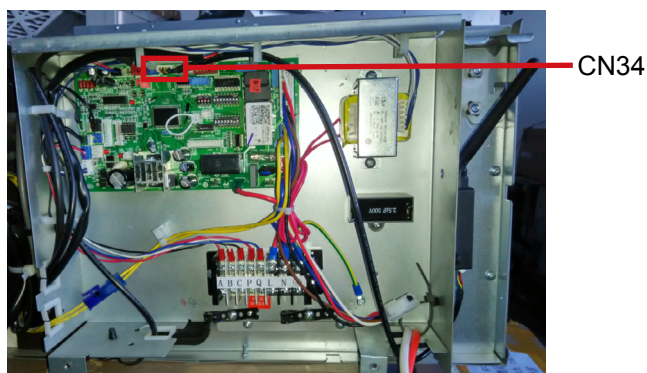

Installation Location Diagram of IDU Wireless Module

25.7 The debugging guidance of Smartlink

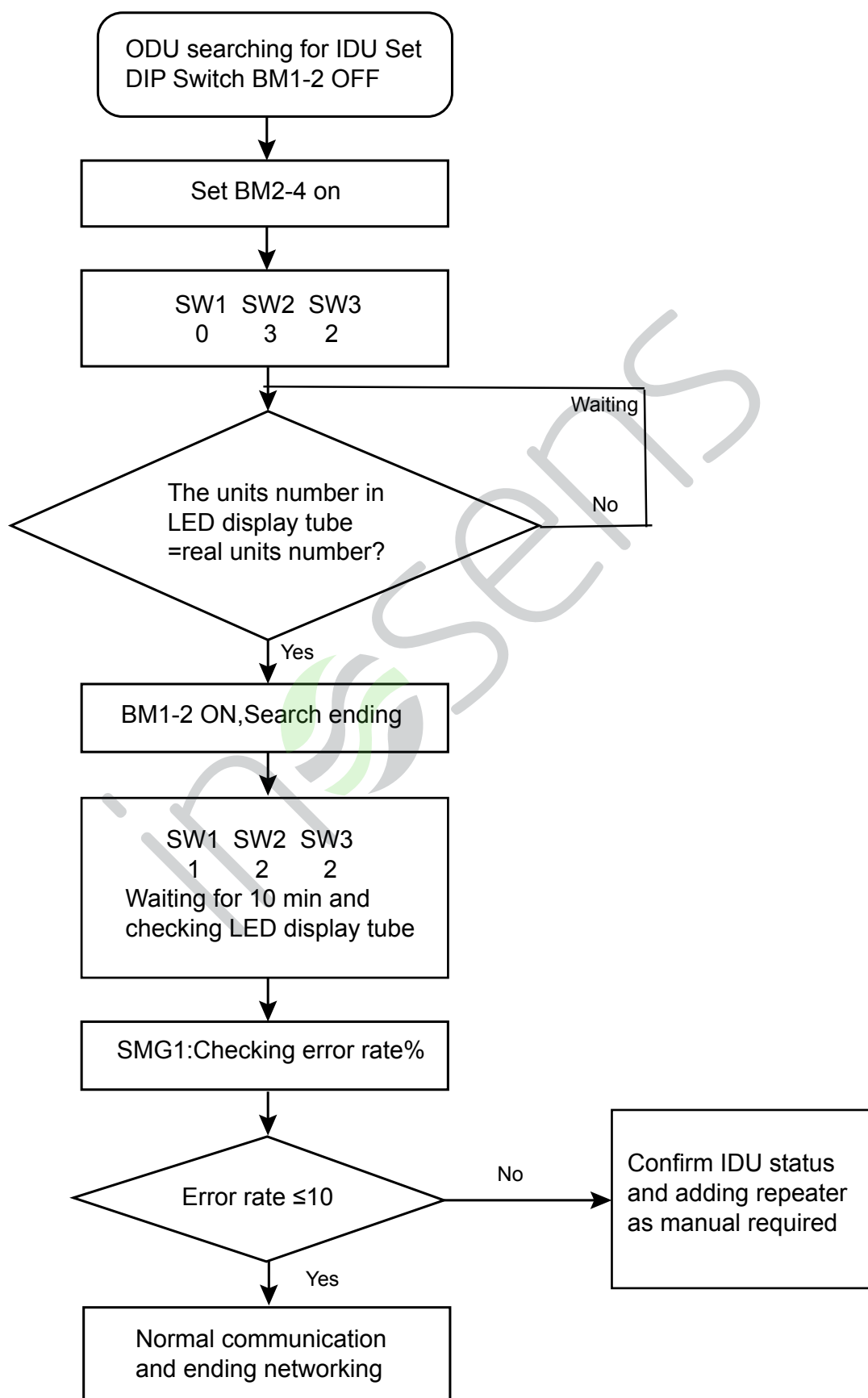

Each system can finish automatic networking debugging separately, as shown in the left debugging chart.

Note:

1. For the first time of debugging Smartlink wireless communication units, the air conditioner units must be powered on separately, other IDUs without networking are forbidden to be powered on. The units finishing the networking must be powered off and then other units can start networking in sequence. All the units can be powered on till all of them finishing networking.

2. After finding all the IDUs, it needs to check the error rate of wireless communication system by ODU LED display area. The checking method of the error rate is shown in table below. 0% indicates the best communication quality and 20% or less can ensure the normal running of the units.

SW1	SW2	SW3	Function	LED Display LD1~4
1	2	2	The first two digits show the percentage of inconsistency between the IDU and the E2 quantity. The last two digits indicates real-time IDU quantity.	For example, 0522 indicates 22 sets of real-time IDUs and 5% of inconsistent communication percentage between the IDUs and the E2 quantity.

3. When error rate is very high, it is necessary to confirm whether the repeater is added in accordance with the standard requirement (one repeater needs to added through per wall).



When debugging the Smartlink, if multiple sets of systems are powered on at the same time, you need to clear the wireless module information according to the following introduction:

1. Clear Master wireless module information

Powering on the ODU, there are three rotary dial switch on the PCB board and SW1/SW2/SW3 are rotated to 1/1/1 respectively. Then turn the ODU PCB board BM2-5 dialing code from OFF to ON, which can clear the information of slave wireless module and repeater stored in the master wireless module.

2. Clear Slave wireless module and Repeater information

There is a built-in button for clearing the pinhole on the slave wireless module and the repeater, as shown in the left figure. Before the slave wireless module and repeater are powered on, use the fine pin to hold the button and then power on the module. Two green lights on the module will flash at the same time, and the information can be cleared about 3s later.

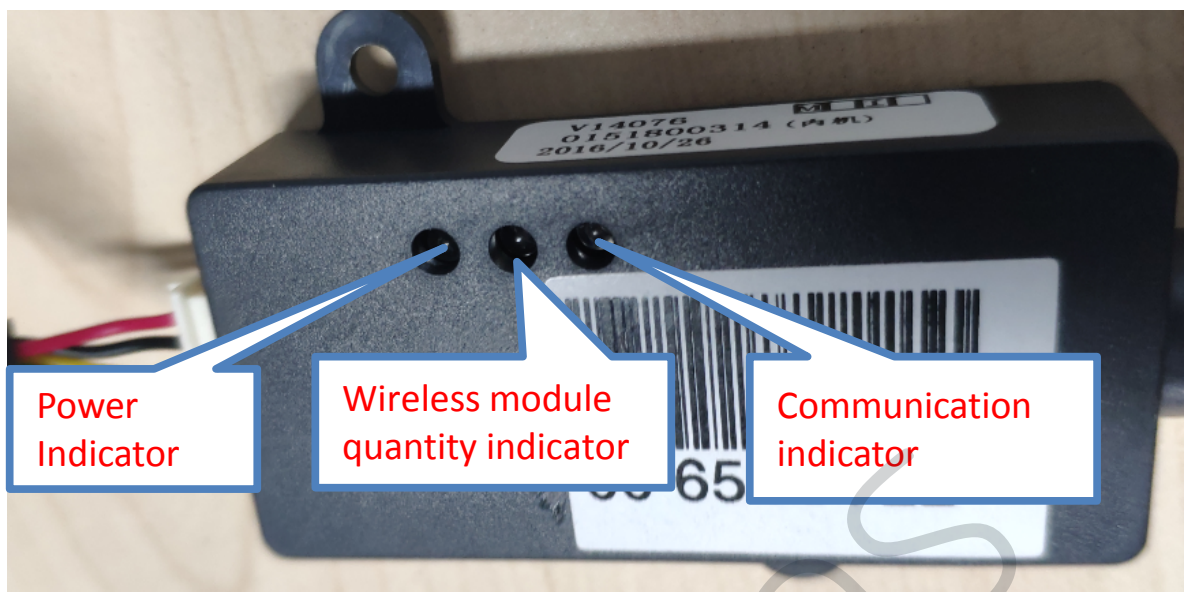

1. The power indicator

After the wireless module is powered on, the indicator light is red. If the power indicator is off, check as the follows:

The internal computer board is not powered on or damaged, or the wireless module is damaged.

2. Wireless module quantity indicator (only suitable for Master Module)

- 1) Indicator status: Fast flashing N times, continue to flash rapidly after interval of about 2s, repeating;
 - 2) Fast flashing "N" times indicates that the total number of Slave /repeater module joining the master module wireless network is "N";
 - 3) If the fast flashes number of master module is different from the total number of Slave/Repeater module installed, it means that Slave/Repeater is not all added to the Master wireless network.
- ① Slave module can confirm whether all the work is done by the number of internal machines. If not all work, it should be checked in turn; ② Repeater needs to be checked by checking the communication indicator;

3. Communication indicator

(1)The indicator light flashes, indicating that the wireless module is communicating normally.

Master module is continuously flashing after powered on,

Slave module /repeater will flash after joining the Master module wireless network.

(2) The Master module communication indicator is not working.

Reasons: ① The control board does not select the wireless communication protocol, or the ② master module is damaged.

(3)The Slave module /repeater indicator is off, indicating that the wireless module ① is not connected to the wireless network (the network wireless signal is not good), ② Slave module /repeater is damaged.

26. Central control & BMS system for MRV5

26.1 Central control system

Central controller information used by MRV5-H system			
No.	Model	Max. outdoor system Qty.	Max. indoor Qty.
1	YCZ-A004	32	256
2	HC-SA164DBT	32	64
3	YCZ-G001	8	32

System schematic

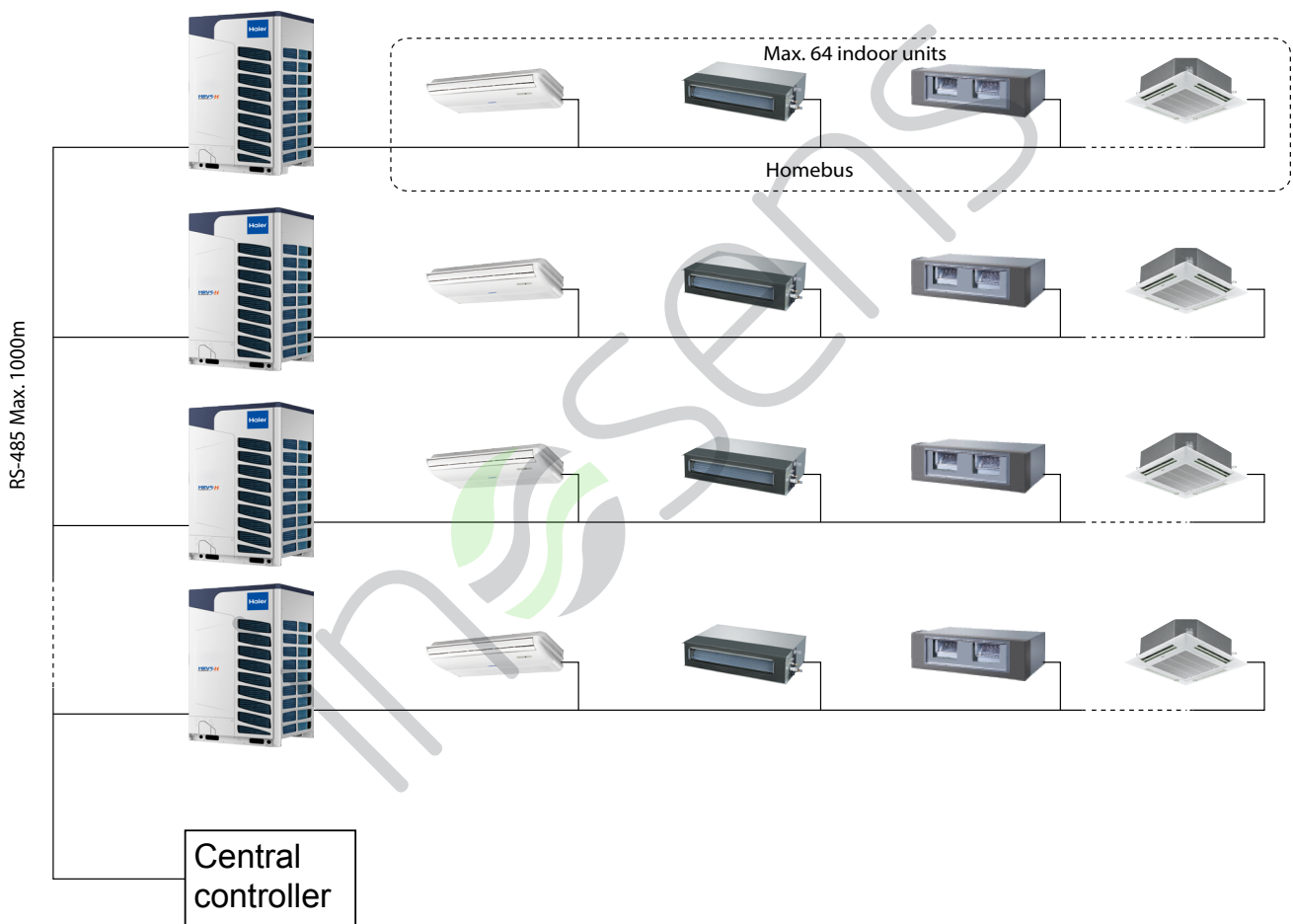

Communication wire connection example



Max.
32
Outdoor
System

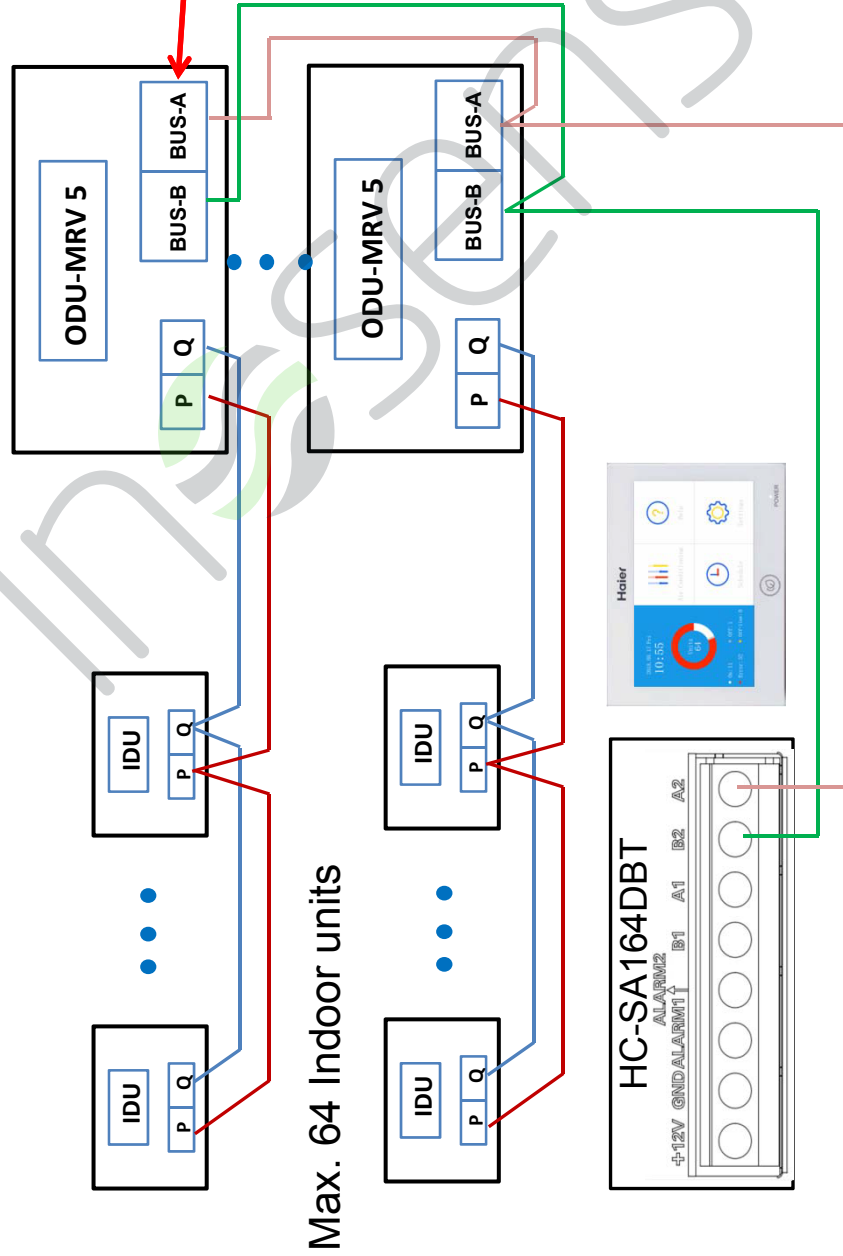

26.2 BMS system

BMS information used by MRV5 system			
No.	Model	Max. outdoor system Qty.	Max. indoor Qty.
1	HCM-01A	32	400
2	HCM-03A	80	1500
3	HCM-05A	32	500
4	HCM-05	32	250

System schematic

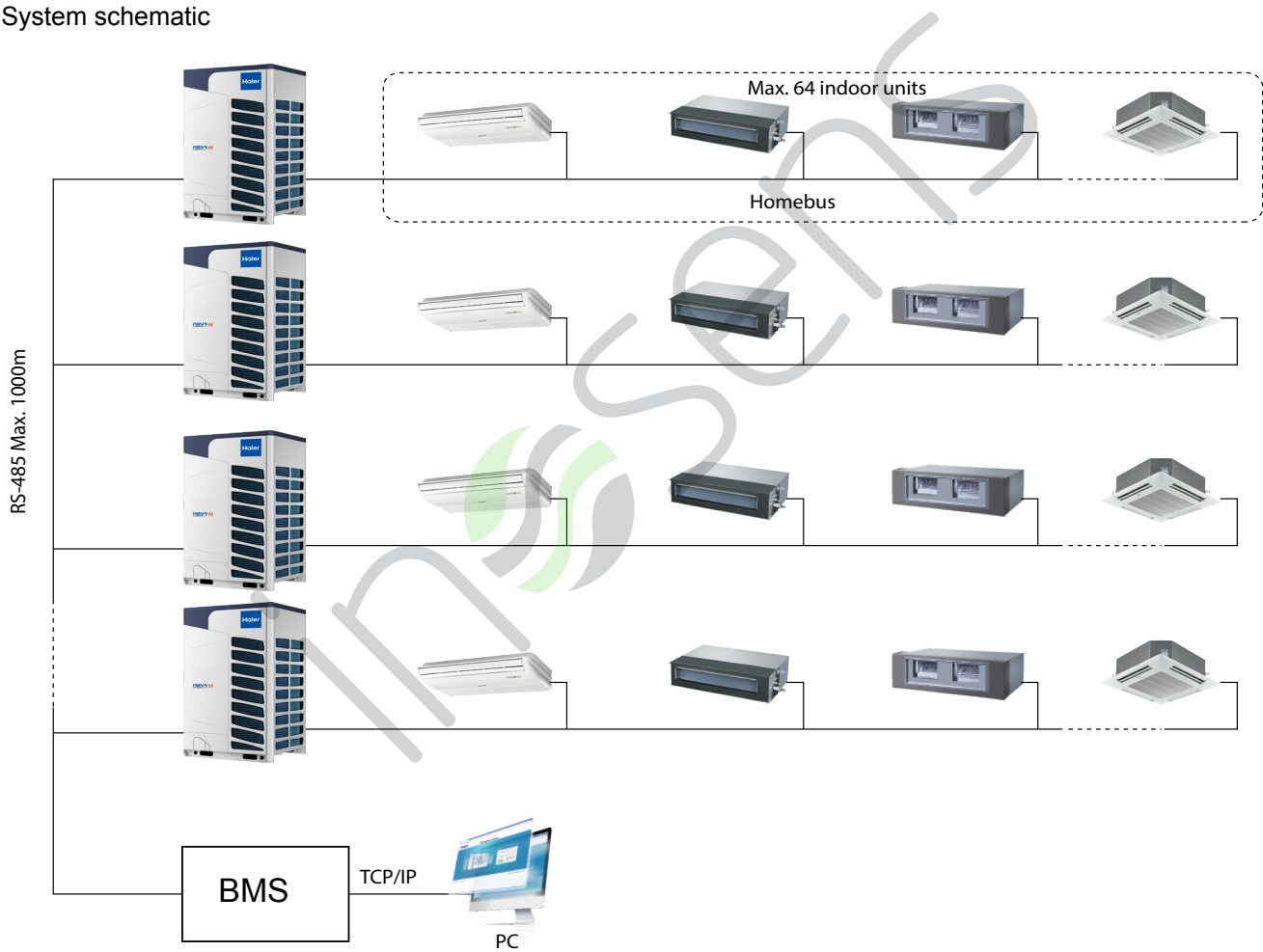

Communication wire connection example

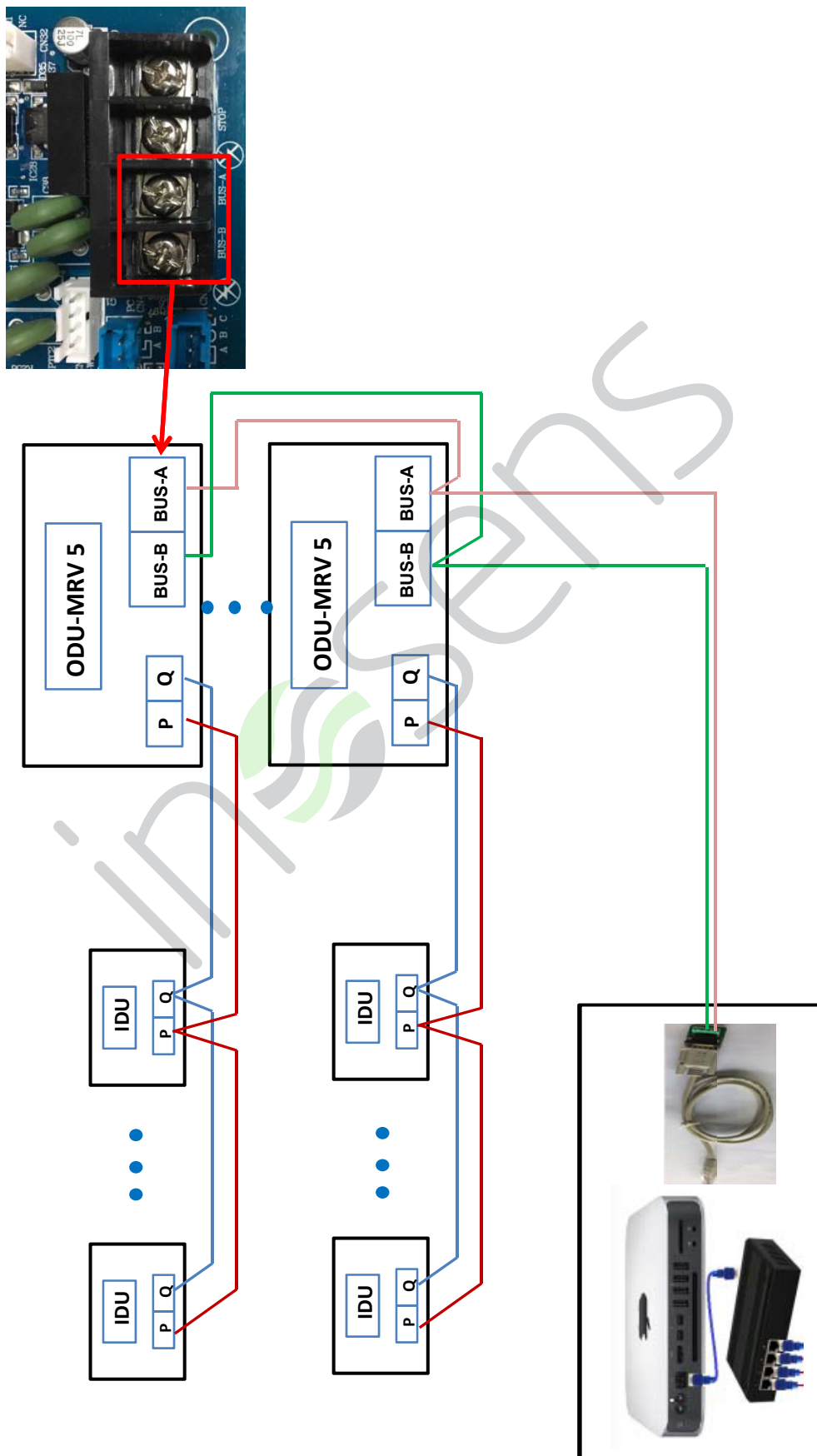

System schematic (Billing system)

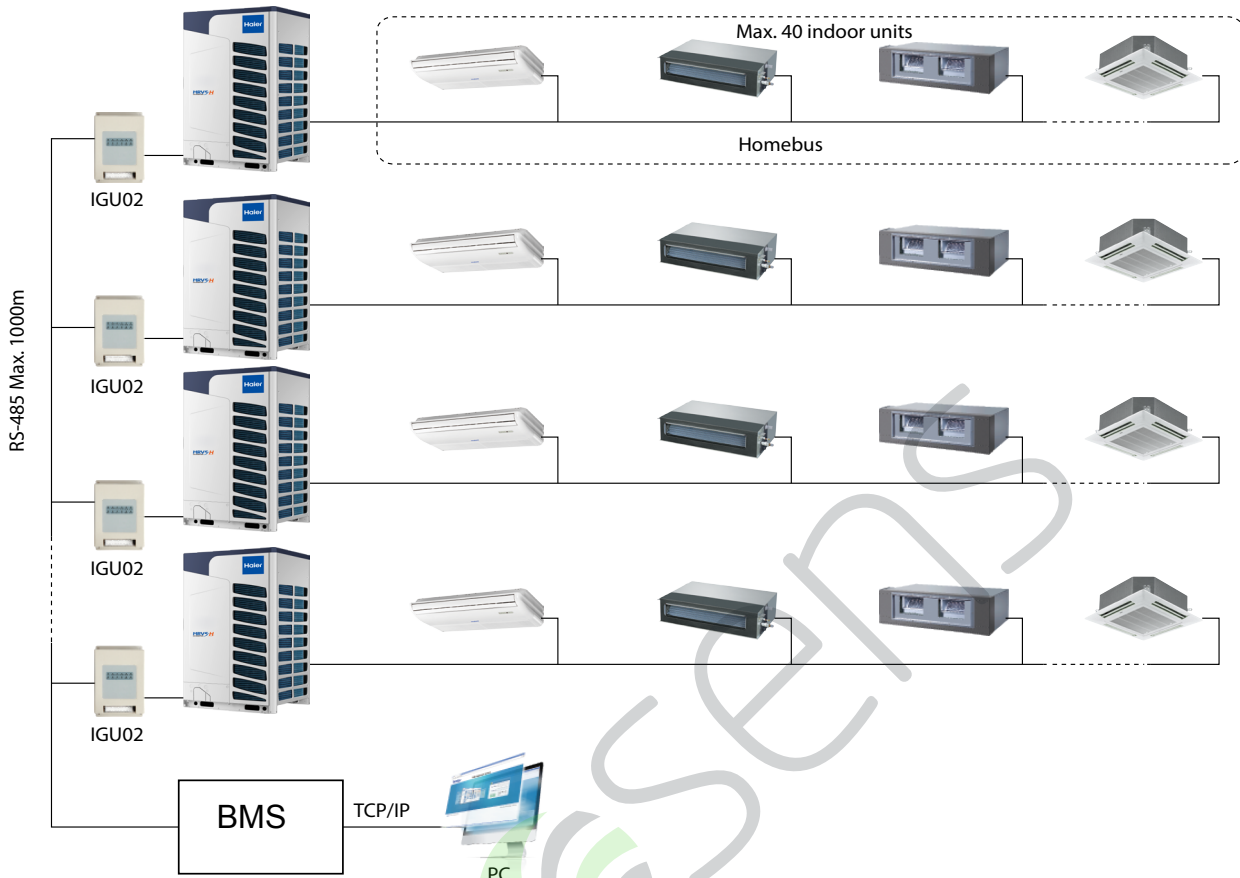

Communication wire connection example

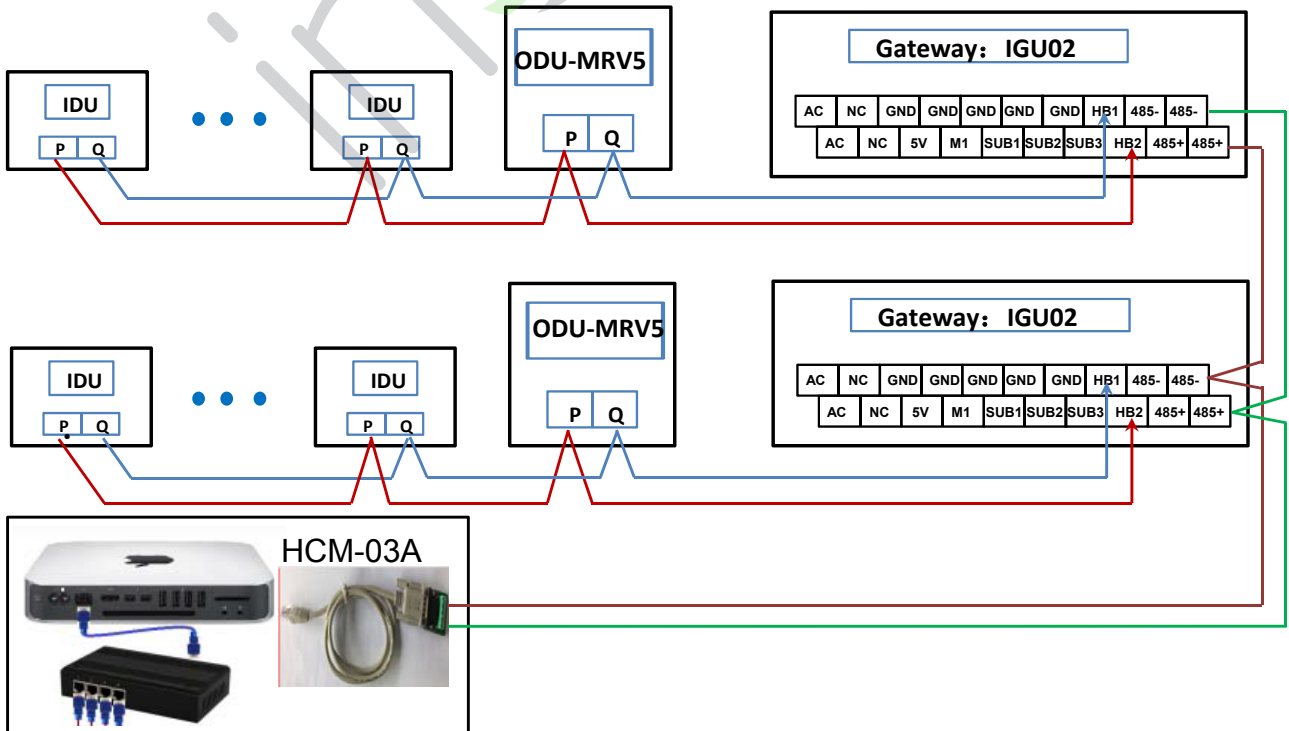

26.3 Dip switch setting for address

1	2	3	4	5	6	7	8	Address
OFF	OFF	OFF	OFF	OFF	OFF	OFF	OFF	0
OFF	OFF	OFF	OFF	OFF	OFF	OFF	<u>ON</u>	1
OFF	OFF	OFF	OFF	OFF	OFF	<u>ON</u>	OFF	2
OFF	OFF	OFF	OFF	OFF	OFF	<u>ON</u>	<u>ON</u>	3
OFF	OFF	OFF	OFF	OFF	<u>ON</u>	OFF	OFF	4
OFF	OFF	OFF	OFF	OFF	<u>ON</u>	OFF	<u>ON</u>	5
OFF	OFF	OFF	OFF	OFF	<u>ON</u>	<u>ON</u>	OFF	6
OFF	OFF	OFF	OFF	OFF	<u>ON</u>	<u>ON</u>	<u>ON</u>	7
OFF	OFF	OFF	OFF	<u>ON</u>	OFF	OFF	OFF	8
OFF	OFF	OFF	OFF	<u>ON</u>	OFF	OFF	<u>ON</u>	9
OFF	OFF	OFF	OFF	<u>ON</u>	OFF	<u>ON</u>	OFF	10
OFF	OFF	OFF	OFF	<u>ON</u>	OFF	<u>ON</u>	<u>ON</u>	11
OFF	OFF	OFF	OFF	<u>ON</u>	<u>ON</u>	OFF	OFF	12
OFF	OFF	OFF	OFF	<u>ON</u>	<u>ON</u>	OFF	<u>ON</u>	13
OFF	OFF	OFF	OFF	<u>ON</u>	<u>ON</u>	<u>ON</u>	OFF	14
OFF	OFF	OFF	OFF	<u>ON</u>	<u>ON</u>	<u>ON</u>	<u>ON</u>	15
OFF	OFF	OFF	<u>ON</u>	OFF	OFF	OFF	OFF	16
OFF	OFF	OFF	<u>ON</u>	OFF	OFF	OFF	<u>ON</u>	17
OFF	OFF	OFF	<u>ON</u>	OFF	OFF	<u>ON</u>	OFF	18
OFF	OFF	OFF	<u>ON</u>	OFF	OFF	<u>ON</u>	<u>ON</u>	19
OFF	OFF	OFF	<u>ON</u>	OFF	<u>ON</u>	OFF	OFF	20
OFF	OFF	OFF	<u>ON</u>	OFF	<u>ON</u>	OFF	<u>ON</u>	21
OFF	OFF	OFF	<u>ON</u>	OFF	<u>ON</u>	<u>ON</u>	OFF	22
OFF	OFF	OFF	<u>ON</u>	<u>ON</u>	<u>ON</u>	<u>ON</u>	<u>ON</u>	23
OFF	OFF	OFF	<u>ON</u>	<u>ON</u>	OFF	OFF	OFF	24
OFF	OFF	OFF	<u>ON</u>	<u>ON</u>	OFF	OFF	<u>ON</u>	25
OFF	OFF	OFF	<u>ON</u>	<u>ON</u>	OFF	<u>ON</u>	OFF	26
OFF	OFF	OFF	<u>ON</u>	<u>ON</u>	OFF	<u>ON</u>	<u>ON</u>	27
OFF	OFF	OFF	<u>ON</u>	<u>ON</u>	<u>ON</u>	OFF	OFF	28
OFF	OFF	OFF	<u>ON</u>	<u>ON</u>	<u>ON</u>	OFF	<u>ON</u>	29
OFF	OFF	OFF	<u>ON</u>	<u>ON</u>	<u>ON</u>	<u>ON</u>	OFF	30
OFF	OFF	OFF	<u>ON</u>	<u>ON</u>	<u>ON</u>	<u>ON</u>	<u>ON</u>	31
OFF	OFF	<u>ON</u>	OFF	OFF	OFF	OFF	OFF	32
OFF	OFF	<u>ON</u>	OFF	OFF	OFF	OFF	<u>ON</u>	33
OFF	OFF	<u>ON</u>	OFF	OFF	OFF	<u>ON</u>	OFF	34
OFF	OFF	<u>ON</u>	OFF	OFF	OFF	<u>ON</u>	<u>ON</u>	35
OFF	OFF	<u>ON</u>	OFF	OFF	<u>ON</u>	OFF	OFF	36
OFF	OFF	<u>ON</u>	OFF	OFF	<u>ON</u>	OFF	<u>ON</u>	37
OFF	OFF	<u>ON</u>	OFF	OFF	<u>ON</u>	<u>ON</u>	OFF	38
OFF	OFF	<u>ON</u>	OFF	OFF	<u>ON</u>	<u>ON</u>	<u>ON</u>	39
OFF	OFF	<u>ON</u>	OFF	<u>ON</u>	OFF	OFF	OFF	40
OFF	OFF	<u>ON</u>	OFF	<u>ON</u>	OFF	OFF	<u>ON</u>	41
OFF	OFF	<u>ON</u>	OFF	<u>ON</u>	OFF	<u>ON</u>	OFF	42
OFF	OFF	<u>ON</u>	OFF	<u>ON</u>	OFF	<u>ON</u>	<u>ON</u>	43
OFF	OFF	<u>ON</u>	OFF	<u>ON</u>	<u>ON</u>	OFF	OFF	44

1	2	3	4	5	6	7	8	Address
OFF	OFF	<u>ON</u>	OFF	<u>ON</u>	<u>ON</u>	OFF	<u>ON</u>	45
OFF	OFF	<u>ON</u>	OFF	<u>ON</u>	<u>ON</u>	<u>ON</u>	OFF	46
OFF	OFF	<u>ON</u>	OFF	<u>ON</u>	<u>ON</u>	<u>ON</u>	<u>ON</u>	47
OFF	OFF	<u>ON</u>	<u>ON</u>	OFF	OFF	OFF	OFF	48
OFF	OFF	<u>ON</u>	<u>ON</u>	OFF	OFF	OFF	<u>ON</u>	49
OFF	OFF	<u>ON</u>	<u>ON</u>	OFF	OFF	<u>ON</u>	OFF	50
OFF	OFF	<u>ON</u>	<u>ON</u>	OFF	OFF	<u>ON</u>	<u>ON</u>	51
OFF	OFF	<u>ON</u>	<u>ON</u>	OFF	<u>ON</u>	OFF	OFF	52
OFF	OFF	<u>ON</u>	<u>ON</u>	OFF	<u>ON</u>	OFF	<u>ON</u>	53
OFF	OFF	<u>ON</u>	<u>ON</u>	OFF	<u>ON</u>	<u>ON</u>	OFF	54
OFF	OFF	<u>ON</u>	<u>ON</u>	OFF	<u>ON</u>	<u>ON</u>	<u>ON</u>	55
OFF	OFF	<u>ON</u>	<u>ON</u>	<u>ON</u>	OFF	OFF	OFF	56
OFF	OFF	<u>ON</u>	<u>ON</u>	<u>ON</u>	OFF	OFF	<u>ON</u>	57
OFF	OFF	<u>ON</u>	<u>ON</u>	<u>ON</u>	OFF	<u>ON</u>	OFF	58
OFF	OFF	<u>ON</u>	<u>ON</u>	<u>ON</u>	OFF	<u>ON</u>	<u>ON</u>	59
OFF	OFF	<u>ON</u>	<u>ON</u>	<u>ON</u>	<u>ON</u>	OFF	OFF	60
OFF	OFF	<u>ON</u>	<u>ON</u>	<u>ON</u>	<u>ON</u>	OFF	<u>ON</u>	61
OFF	OFF	<u>ON</u>	<u>ON</u>	<u>ON</u>	<u>ON</u>	<u>ON</u>	OFF	62
OFF	OFF	<u>ON</u>	<u>ON</u>	<u>ON</u>	<u>ON</u>	<u>ON</u>	<u>ON</u>	63
OFF	<u>ON</u>	OFF	OFF	OFF	OFF	OFF	OFF	64
OFF	<u>ON</u>	OFF	OFF	OFF	OFF	OFF	<u>ON</u>	65
OFF	<u>ON</u>	OFF	OFF	OFF	OFF	<u>ON</u>	OFF	66
OFF	<u>ON</u>	OFF	OFF	OFF	OFF	<u>ON</u>	<u>ON</u>	67
OFF	<u>ON</u>	OFF	OFF	OFF	<u>ON</u>	OFF	OFF	68
OFF	<u>ON</u>	OFF	OFF	OFF	<u>ON</u>	OFF	<u>ON</u>	69
OFF	<u>ON</u>	OFF	OFF	OFF	<u>ON</u>	<u>ON</u>	OFF	70
OFF	<u>ON</u>	OFF	OFF	OFF	<u>ON</u>	<u>ON</u>	<u>ON</u>	71
OFF	<u>ON</u>	OFF	OFF	<u>ON</u>	OFF	OFF	OFF	72
OFF	<u>ON</u>	OFF	OFF	<u>ON</u>	OFF	OFF	<u>ON</u>	73
OFF	<u>ON</u>	OFF	OFF	<u>ON</u>	OFF	<u>ON</u>	OFF	74
OFF	<u>ON</u>	OFF	OFF	<u>ON</u>	OFF	<u>ON</u>	<u>ON</u>	75
OFF	<u>ON</u>	OFF	OFF	<u>ON</u>	<u>ON</u>	OFF	OFF	76
OFF	<u>ON</u>	OFF	OFF	<u>ON</u>	<u>ON</u>	OFF	<u>ON</u>	77
OFF	<u>ON</u>	OFF	OFF	<u>ON</u>	<u>ON</u>	<u>ON</u>	OFF	78
OFF	<u>ON</u>	OFF	OFF	<u>ON</u>	<u>ON</u>	<u>ON</u>	<u>ON</u>	79
OFF	<u>ON</u>	OFF	<u>ON</u>	OFF	OFF	OFF	OFF	80
OFF	<u>ON</u>	OFF	<u>ON</u>	OFF	OFF	OFF	<u>ON</u>	81
OFF	<u>ON</u>	OFF	<u>ON</u>	OFF	OFF	<u>ON</u>	OFF	82
OFF	<u>ON</u>	OFF	<u>ON</u>	OFF	OFF	<u>ON</u>	<u>ON</u>	83
OFF	<u>ON</u>	OFF	<u>ON</u>	OFF	<u>ON</u>	OFF	OFF	84
OFF	<u>ON</u>	OFF	<u>ON</u>	OFF	<u>ON</u>	OFF	<u>ON</u>	85
OFF	<u>ON</u>	OFF	<u>ON</u>	OFF	<u>ON</u>	<u>ON</u>	OFF	86
OFF	<u>ON</u>	OFF	<u>ON</u>	<u>OFF</u>	ON	ON	ON	87
OFF	<u>ON</u>	OFF	<u>ON</u>	<u>ON</u>	OFF	OFF	OFF	88
OFF	<u>ON</u>	OFF	<u>ON</u>	<u>ON</u>	OFF	OFF	<u>ON</u>	89
OFF	<u>ON</u>	OFF	<u>ON</u>	<u>ON</u>	OFF	<u>ON</u>	OFF	90

1	2	3	4	5	6	7	8	Address
OFF	<u>ON</u>	OFF	<u>ON</u>	<u>ON</u>	OFF	<u>ON</u>	<u>ON</u>	91
OFF	<u>ON</u>	OFF	<u>ON</u>	<u>ON</u>	<u>ON</u>	OFF	OFF	92
OFF	<u>ON</u>	OFF	<u>ON</u>	<u>ON</u>	<u>ON</u>	OFF	<u>ON</u>	93
OFF	<u>ON</u>	OFF	<u>ON</u>	<u>ON</u>	<u>ON</u>	<u>ON</u>	OFF	94
OFF	<u>ON</u>	OFF	<u>ON</u>	<u>ON</u>	<u>ON</u>	<u>ON</u>	<u>ON</u>	95
OFF	<u>ON</u>	<u>ON</u>	OFF	OFF	OFF	OFF	OFF	96
OFF	<u>ON</u>	<u>ON</u>	OFF	OFF	OFF	OFF	<u>ON</u>	97
OFF	<u>ON</u>	<u>ON</u>	OFF	OFF	OFF	<u>ON</u>	OFF	98
OFF	<u>ON</u>	<u>ON</u>	OFF	OFF	OFF	<u>ON</u>	<u>ON</u>	99
OFF	<u>ON</u>	<u>ON</u>	OFF	OFF	<u>ON</u>	OFF	OFF	100
OFF	<u>ON</u>	<u>ON</u>	OFF	OFF	<u>ON</u>	OFF	<u>ON</u>	101
OFF	<u>ON</u>	<u>ON</u>	OFF	OFF	<u>ON</u>	<u>ON</u>	OFF	102
OFF	<u>ON</u>	<u>ON</u>	OFF	OFF	<u>ON</u>	<u>ON</u>	<u>ON</u>	103
OFF	<u>ON</u>	<u>ON</u>	OFF	<u>ON</u>	OFF	OFF	OFF	104
OFF	<u>ON</u>	<u>ON</u>	OFF	<u>ON</u>	OFF	OFF	<u>ON</u>	105
OFF	<u>ON</u>	<u>ON</u>	OFF	<u>ON</u>	OFF	<u>ON</u>	OFF	106
OFF	<u>ON</u>	<u>ON</u>	OFF	<u>ON</u>	OFF	<u>ON</u>	<u>ON</u>	107
OFF	<u>ON</u>	<u>ON</u>	OFF	<u>ON</u>	<u>ON</u>	OFF	OFF	108
OFF	<u>ON</u>	<u>ON</u>	OFF	<u>ON</u>	<u>ON</u>	OFF	<u>ON</u>	109
OFF	<u>ON</u>	<u>ON</u>	OFF	<u>ON</u>	<u>ON</u>	<u>ON</u>	OFF	110
OFF	<u>ON</u>	<u>ON</u>	OFF	<u>ON</u>	<u>ON</u>	<u>ON</u>	<u>ON</u>	111
OFF	<u>ON</u>	<u>ON</u>	<u>ON</u>	OFF	OFF	OFF	OFF	112
OFF	<u>ON</u>	<u>ON</u>	<u>ON</u>	OFF	OFF	OFF	<u>ON</u>	113
OFF	<u>ON</u>	<u>ON</u>	<u>ON</u>	OFF	OFF	<u>ON</u>	OFF	114
OFF	<u>ON</u>	<u>ON</u>	<u>ON</u>	OFF	OFF	<u>ON</u>	<u>ON</u>	115
OFF	<u>ON</u>	<u>ON</u>	<u>ON</u>	OFF	<u>ON</u>	OFF	OFF	116
OFF	<u>ON</u>	<u>ON</u>	<u>ON</u>	OFF	<u>ON</u>	OFF	<u>ON</u>	117
OFF	<u>ON</u>	<u>ON</u>	<u>ON</u>	OFF	<u>ON</u>	<u>ON</u>	OFF	118
OFF	<u>ON</u>	<u>ON</u>	<u>ON</u>	OFF	<u>ON</u>	<u>ON</u>	<u>ON</u>	119
OFF	<u>ON</u>	<u>ON</u>	<u>ON</u>	<u>ON</u>	OFF	OFF	OFF	120
OFF	<u>ON</u>	<u>ON</u>	<u>ON</u>	<u>ON</u>	OFF	OFF	<u>ON</u>	121
OFF	<u>ON</u>	<u>ON</u>	<u>ON</u>	<u>ON</u>	OFF	<u>ON</u>	OFF	122
OFF	<u>ON</u>	<u>ON</u>	<u>ON</u>	<u>ON</u>	OFF	<u>ON</u>	<u>ON</u>	123
OFF	<u>ON</u>	<u>ON</u>	<u>ON</u>	<u>ON</u>	<u>ON</u>	OFF	OFF	124
OFF	<u>ON</u>	<u>ON</u>	<u>ON</u>	<u>ON</u>	<u>ON</u>	OFF	<u>ON</u>	125
OFF	<u>ON</u>	<u>ON</u>	<u>ON</u>	<u>ON</u>	<u>ON</u>	<u>ON</u>	OFF	126
OFF	<u>ON</u>	<u>ON</u>	<u>ON</u>	<u>ON</u>	<u>ON</u>	<u>ON</u>	<u>ON</u>	127

1	2	3	4	5	6	7	8	Address
<u>ON</u>	OFF	OFF	OFF	OFF	OFF	OFF	OFF	128
<u>ON</u>	OFF	OFF	OFF	OFF	OFF	OFF	<u>ON</u>	129
<u>ON</u>	OFF	OFF	OFF	OFF	OFF	<u>ON</u>	OFF	130
<u>ON</u>	OFF	OFF	OFF	OFF	OFF	<u>ON</u>	<u>ON</u>	131
<u>ON</u>	OFF	OFF	OFF	OFF	<u>ON</u>	OFF	OFF	132
<u>ON</u>	OFF	OFF	OFF	OFF	<u>ON</u>	OFF	<u>ON</u>	133
<u>ON</u>	OFF	OFF	OFF	OFF	<u>ON</u>	<u>ON</u>	OFF	134
<u>ON</u>	OFF	OFF	OFF	OFF	<u>ON</u>	<u>ON</u>	<u>ON</u>	135
<u>ON</u>	OFF	OFF	OFF	<u>ON</u>	OFF	OFF	OFF	136
<u>ON</u>	OFF	OFF	OFF	<u>ON</u>	OFF	OFF	<u>ON</u>	137
<u>ON</u>	OFF	OFF	OFF	<u>ON</u>	OFF	<u>ON</u>	OFF	138
<u>ON</u>	OFF	OFF	OFF	<u>ON</u>	OFF	<u>ON</u>	<u>ON</u>	139
<u>ON</u>	OFF	OFF	OFF	<u>ON</u>	<u>ON</u>	OFF	OFF	140
<u>ON</u>	OFF	OFF	OFF	<u>ON</u>	<u>ON</u>	OFF	<u>ON</u>	141
<u>ON</u>	OFF	OFF	OFF	<u>ON</u>	<u>ON</u>	<u>ON</u>	OFF	142
<u>ON</u>	OFF	OFF	OFF	<u>ON</u>	<u>ON</u>	<u>ON</u>	<u>ON</u>	143
<u>ON</u>	OFF	OFF	<u>ON</u>	OFF	OFF	OFF	OFF	144
<u>ON</u>	OFF	OFF	<u>ON</u>	OFF	OFF	OFF	<u>ON</u>	145
<u>ON</u>	OFF	OFF	<u>ON</u>	OFF	OFF	<u>ON</u>	OFF	146
<u>ON</u>	OFF	OFF	<u>ON</u>	OFF	OFF	<u>ON</u>	<u>ON</u>	147
<u>ON</u>	OFF	OFF	<u>ON</u>	OFF	<u>ON</u>	OFF	OFF	148
<u>ON</u>	OFF	OFF	<u>ON</u>	OFF	<u>ON</u>	OFF	<u>ON</u>	149
<u>ON</u>	OFF	OFF	<u>ON</u>	OFF	<u>ON</u>	<u>ON</u>	OFF	150
<u>ON</u>	OFF	OFF	<u>ON</u>	<u>ON</u>	<u>ON</u>	<u>ON</u>	<u>ON</u>	151
<u>ON</u>	OFF	OFF	<u>ON</u>	<u>ON</u>	OFF	OFF	OFF	152
<u>ON</u>	OFF	OFF	<u>ON</u>	<u>ON</u>	OFF	OFF	<u>ON</u>	153
<u>ON</u>	OFF	OFF	<u>ON</u>	<u>ON</u>	OFF	<u>ON</u>	OFF	154
<u>ON</u>	OFF	OFF	<u>ON</u>	<u>ON</u>	OFF	<u>ON</u>	<u>ON</u>	155
<u>ON</u>	OFF	OFF	<u>ON</u>	<u>ON</u>	<u>ON</u>	OFF	OFF	156
<u>ON</u>	OFF	OFF	<u>ON</u>	<u>ON</u>	<u>ON</u>	OFF	<u>ON</u>	157
<u>ON</u>	OFF	OFF	<u>ON</u>	<u>ON</u>	<u>ON</u>	<u>ON</u>	OFF	158
<u>ON</u>	OFF	OFF	<u>ON</u>	<u>ON</u>	<u>ON</u>	<u>ON</u>	<u>ON</u>	159
<u>ON</u>	OFF	<u>ON</u>	OFF	OFF	OFF	OFF	OFF	160
<u>ON</u>	OFF	<u>ON</u>	OFF	OFF	OFF	OFF	<u>ON</u>	161
<u>ON</u>	OFF	<u>ON</u>	OFF	OFF	OFF	<u>ON</u>	OFF	162
<u>ON</u>	OFF	<u>ON</u>	OFF	OFF	OFF	<u>ON</u>	<u>ON</u>	163
<u>ON</u>	OFF	<u>ON</u>	OFF	OFF	<u>ON</u>	OFF	OFF	164
<u>ON</u>	OFF	<u>ON</u>	OFF	OFF	<u>ON</u>	OFF	<u>ON</u>	165
<u>ON</u>	OFF	<u>ON</u>	OFF	OFF	<u>ON</u>	<u>ON</u>	OFF	166
<u>ON</u>	OFF	<u>ON</u>	OFF	OFF	<u>ON</u>	<u>ON</u>	<u>ON</u>	167
<u>ON</u>	OFF	<u>ON</u>	OFF	<u>ON</u>	OFF	OFF	OFF	168
<u>ON</u>	OFF	<u>ON</u>	OFF	<u>ON</u>	OFF	OFF	<u>ON</u>	169
<u>ON</u>	OFF	<u>ON</u>	OFF	<u>ON</u>	OFF	<u>ON</u>	OFF	170
<u>ON</u>	OFF	<u>ON</u>	OFF	<u>ON</u>	OFF	<u>ON</u>	<u>ON</u>	171
<u>ON</u>	OFF	<u>ON</u>	OFF	<u>ON</u>	<u>ON</u>	OFF	OFF	172

1	2	3	4	5	6	7	8	Address
<u>ON</u>	OFF	<u>ON</u>	OFF	<u>ON</u>	<u>ON</u>	OFF	<u>ON</u>	173
<u>ON</u>	OFF	<u>ON</u>	OFF	<u>ON</u>	<u>ON</u>	<u>ON</u>	OFF	174
<u>ON</u>	OFF	<u>ON</u>	OFF	<u>ON</u>	<u>ON</u>	<u>ON</u>	<u>ON</u>	175
<u>ON</u>	OFF	<u>ON</u>	<u>ON</u>	OFF	OFF	OFF	OFF	176
<u>ON</u>	OFF	<u>ON</u>	<u>ON</u>	OFF	OFF	OFF	<u>ON</u>	177
<u>ON</u>	OFF	<u>ON</u>	<u>ON</u>	OFF	OFF	<u>ON</u>	OFF	178
<u>ON</u>	OFF	<u>ON</u>	<u>ON</u>	OFF	OFF	<u>ON</u>	<u>ON</u>	179
<u>ON</u>	OFF	<u>ON</u>	<u>ON</u>	OFF	<u>ON</u>	OFF	OFF	180
<u>ON</u>	OFF	<u>ON</u>	<u>ON</u>	OFF	<u>ON</u>	OFF	<u>ON</u>	181
<u>ON</u>	OFF	<u>ON</u>	<u>ON</u>	OFF	<u>ON</u>	<u>ON</u>	OFF	182
<u>ON</u>	OFF	<u>ON</u>	<u>ON</u>	OFF	<u>ON</u>	<u>ON</u>	<u>ON</u>	183
<u>ON</u>	OFF	<u>ON</u>	<u>ON</u>	<u>ON</u>	OFF	OFF	OFF	184
<u>ON</u>	OFF	<u>ON</u>	<u>ON</u>	<u>ON</u>	OFF	OFF	<u>ON</u>	185
<u>ON</u>	OFF	<u>ON</u>	<u>ON</u>	<u>ON</u>	OFF	<u>ON</u>	OFF	186
<u>ON</u>	OFF	<u>ON</u>	<u>ON</u>	<u>ON</u>	OFF	<u>ON</u>	<u>ON</u>	187
<u>ON</u>	OFF	<u>ON</u>	<u>ON</u>	<u>ON</u>	<u>ON</u>	OFF	OFF	188
<u>ON</u>	OFF	<u>ON</u>	<u>ON</u>	<u>ON</u>	<u>ON</u>	OFF	<u>ON</u>	189
<u>ON</u>	OFF	<u>ON</u>	<u>ON</u>	<u>ON</u>	<u>ON</u>	<u>ON</u>	OFF	190
<u>ON</u>	OFF	<u>ON</u>	<u>ON</u>	<u>ON</u>	<u>ON</u>	<u>ON</u>	<u>ON</u>	191
<u>ON</u>	<u>ON</u>	OFF	OFF	OFF	OFF	OFF	OFF	192
<u>ON</u>	<u>ON</u>	OFF	OFF	OFF	OFF	OFF	<u>ON</u>	193
<u>ON</u>	<u>ON</u>	OFF	OFF	OFF	OFF	<u>ON</u>	OFF	194
<u>ON</u>	<u>ON</u>	OFF	OFF	OFF	OFF	<u>ON</u>	<u>ON</u>	195
<u>ON</u>	<u>ON</u>	OFF	OFF	OFF	<u>ON</u>	OFF	OFF	196
<u>ON</u>	<u>ON</u>	OFF	OFF	OFF	<u>ON</u>	OFF	<u>ON</u>	197
<u>ON</u>	<u>ON</u>	OFF	OFF	OFF	<u>ON</u>	<u>ON</u>	OFF	198
<u>ON</u>	<u>ON</u>	OFF	OFF	OFF	<u>ON</u>	<u>ON</u>	<u>ON</u>	199
<u>ON</u>	<u>ON</u>	OFF	OFF	<u>ON</u>	OFF	OFF	OFF	200
<u>ON</u>	<u>ON</u>	OFF	OFF	<u>ON</u>	OFF	OFF	<u>ON</u>	201
<u>ON</u>	<u>ON</u>	OFF	OFF	<u>ON</u>	OFF	<u>ON</u>	OFF	202
<u>ON</u>	<u>ON</u>	OFF	OFF	<u>ON</u>	OFF	<u>ON</u>	<u>ON</u>	203
<u>ON</u>	<u>ON</u>	OFF	OFF	<u>ON</u>	<u>ON</u>	OFF	OFF	204
<u>ON</u>	<u>ON</u>	OFF	OFF	<u>ON</u>	<u>ON</u>	OFF	<u>ON</u>	205
<u>ON</u>	<u>ON</u>	OFF	OFF	<u>ON</u>	<u>ON</u>	<u>ON</u>	OFF	206
<u>ON</u>	<u>ON</u>	OFF	OFF	<u>ON</u>	<u>ON</u>	<u>ON</u>	<u>ON</u>	207
<u>ON</u>	<u>ON</u>	OFF	<u>ON</u>	OFF	OFF	OFF	OFF	208
<u>ON</u>	<u>ON</u>	OFF	<u>ON</u>	OFF	OFF	OFF	<u>ON</u>	209
<u>ON</u>	<u>ON</u>	OFF	<u>ON</u>	OFF	OFF	<u>ON</u>	OFF	210
<u>ON</u>	<u>ON</u>	OFF	<u>ON</u>	OFF	OFF	<u>ON</u>	<u>ON</u>	211
<u>ON</u>	<u>ON</u>	OFF	<u>ON</u>	OFF	<u>ON</u>	OFF	OFF	212
<u>ON</u>	<u>ON</u>	OFF	<u>ON</u>	OFF	<u>ON</u>	OFF	<u>ON</u>	213
<u>ON</u>	<u>ON</u>	OFF	<u>ON</u>	OFF	<u>ON</u>	<u>ON</u>	OFF	214
<u>ON</u>	<u>ON</u>	OFF	<u>ON</u>	<u>OFF</u>	<u>ON</u>	<u>ON</u>	<u>ON</u>	215
<u>ON</u>	<u>ON</u>	OFF	<u>ON</u>	<u>ON</u>	OFF	OFF	OFF	216
<u>ON</u>	<u>ON</u>	OFF	<u>ON</u>	<u>ON</u>	OFF	OFF	<u>ON</u>	217
<u>ON</u>	<u>ON</u>	OFF	<u>ON</u>	<u>ON</u>	OFF	<u>ON</u>	OFF	218

1	2	3	4	5	6	7	8	Address
<u>ON</u>	<u>ON</u>	OFF	<u>ON</u>	<u>ON</u>	OFF	<u>ON</u>	<u>ON</u>	219
<u>ON</u>	<u>ON</u>	OFF	<u>ON</u>	<u>ON</u>	<u>ON</u>	OFF	OFF	220
<u>ON</u>	<u>ON</u>	OFF	<u>ON</u>	<u>ON</u>	<u>ON</u>	OFF	<u>ON</u>	221
<u>ON</u>	<u>ON</u>	OFF	<u>ON</u>	<u>ON</u>	<u>ON</u>	<u>ON</u>	OFF	222
<u>ON</u>	<u>ON</u>	OFF	<u>ON</u>	<u>ON</u>	<u>ON</u>	<u>ON</u>	<u>ON</u>	223
<u>ON</u>	<u>ON</u>	<u>ON</u>	OFF	OFF	OFF	OFF	OFF	224
<u>ON</u>	<u>ON</u>	<u>ON</u>	OFF	OFF	OFF	OFF	<u>ON</u>	225
<u>ON</u>	<u>ON</u>	<u>ON</u>	OFF	OFF	OFF	<u>ON</u>	OFF	226
<u>ON</u>	<u>ON</u>	<u>ON</u>	OFF	OFF	OFF	<u>ON</u>	<u>ON</u>	227
<u>ON</u>	<u>ON</u>	<u>ON</u>	OFF	OFF	<u>ON</u>	OFF	OFF	228
<u>ON</u>	<u>ON</u>	<u>ON</u>	OFF	OFF	<u>ON</u>	OFF	<u>ON</u>	229
<u>ON</u>	<u>ON</u>	<u>ON</u>	OFF	OFF	<u>ON</u>	<u>ON</u>	OFF	230
<u>ON</u>	<u>ON</u>	<u>ON</u>	OFF	OFF	<u>ON</u>	<u>ON</u>	<u>ON</u>	231
<u>ON</u>	<u>ON</u>	<u>ON</u>	OFF	<u>ON</u>	OFF	OFF	OFF	232
<u>ON</u>	<u>ON</u>	<u>ON</u>	OFF	<u>ON</u>	OFF	OFF	<u>ON</u>	233
<u>ON</u>	<u>ON</u>	<u>ON</u>	OFF	<u>ON</u>	OFF	<u>ON</u>	OFF	234
<u>ON</u>	<u>ON</u>	<u>ON</u>	OFF	<u>ON</u>	OFF	<u>ON</u>	<u>ON</u>	235
<u>ON</u>	<u>ON</u>	<u>ON</u>	OFF	<u>ON</u>	<u>ON</u>	OFF	OFF	236
<u>ON</u>	<u>ON</u>	<u>ON</u>	OFF	<u>ON</u>	<u>ON</u>	OFF	<u>ON</u>	237
<u>ON</u>	<u>ON</u>	<u>ON</u>	OFF	<u>ON</u>	<u>ON</u>	<u>ON</u>	OFF	238
<u>ON</u>	<u>ON</u>	<u>ON</u>	OFF	<u>ON</u>	<u>ON</u>	<u>ON</u>	<u>ON</u>	239
<u>ON</u>	<u>ON</u>	<u>ON</u>	<u>ON</u>	OFF	OFF	OFF	OFF	240
<u>ON</u>	<u>ON</u>	<u>ON</u>	<u>ON</u>	OFF	OFF	OFF	<u>ON</u>	241
<u>ON</u>	<u>ON</u>	<u>ON</u>	<u>ON</u>	OFF	OFF	<u>ON</u>	OFF	242
<u>ON</u>	<u>ON</u>	<u>ON</u>	<u>ON</u>	OFF	OFF	<u>ON</u>	<u>ON</u>	243
<u>ON</u>	<u>ON</u>	<u>ON</u>	<u>ON</u>	OFF	<u>ON</u>	OFF	OFF	244
<u>ON</u>	<u>ON</u>	<u>ON</u>	<u>ON</u>	OFF	<u>ON</u>	OFF	<u>ON</u>	245
<u>ON</u>	<u>ON</u>	<u>ON</u>	<u>ON</u>	OFF	<u>ON</u>	<u>ON</u>	OFF	246
<u>ON</u>	<u>ON</u>	<u>ON</u>	<u>ON</u>	OFF	<u>ON</u>	<u>ON</u>	<u>ON</u>	247
<u>ON</u>	<u>ON</u>	<u>ON</u>	<u>ON</u>	<u>ON</u>	OFF	OFF	OFF	248
<u>ON</u>	<u>ON</u>	<u>ON</u>	<u>ON</u>	<u>ON</u>	OFF	OFF	<u>ON</u>	249
<u>ON</u>	<u>ON</u>	<u>ON</u>	<u>ON</u>	<u>ON</u>	OFF	<u>ON</u>	OFF	250
<u>ON</u>	<u>ON</u>	<u>ON</u>	<u>ON</u>	<u>ON</u>	OFF	<u>ON</u>	<u>ON</u>	251
<u>ON</u>	<u>ON</u>	<u>ON</u>	<u>ON</u>	<u>ON</u>	<u>ON</u>	OFF	OFF	252
<u>ON</u>	<u>ON</u>	<u>ON</u>	<u>ON</u>	<u>ON</u>	<u>ON</u>	OFF	<u>ON</u>	253
<u>ON</u>	<u>ON</u>	<u>ON</u>	<u>ON</u>	<u>ON</u>	<u>ON</u>	<u>ON</u>	OFF	254
<u>ON</u>	<u>ON</u>	<u>ON</u>	<u>ON</u>	<u>ON</u>	<u>ON</u>	<u>ON</u>	<u>ON</u>	255

Appendix table for manual updated information

No.	Version	Updated information





Haier Commercial Air Condition

ADDRESS: No.1 Haier Road, Hi-tech Zone, Qingdao 266101 P.R. China

Web: [Http://www.haier.com](http://www.haier.com)