

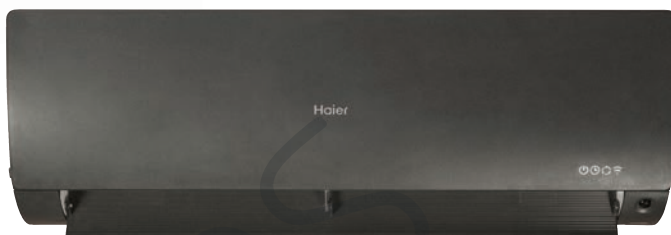

DESIGN: Matt

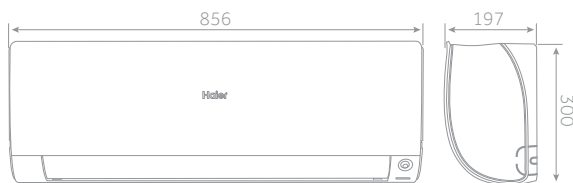

AS25 - AS35 - AS42



AS50

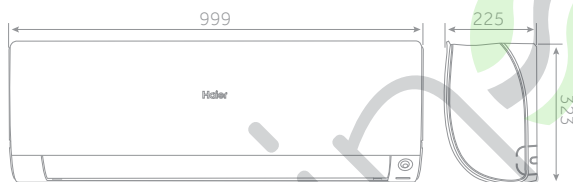

AS71

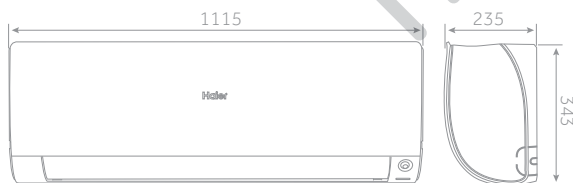

Montageplatte

AS25-AS35-AS42-AS50

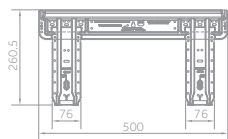

AS71

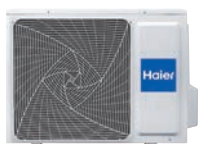
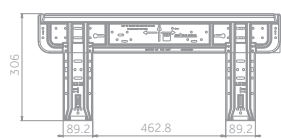

2,5 kW - 3,5 kW - 4,2 kW

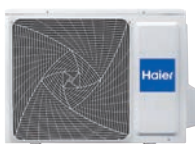

5,0 kW



7,1 kW

1U25 - 1U35- 1U42

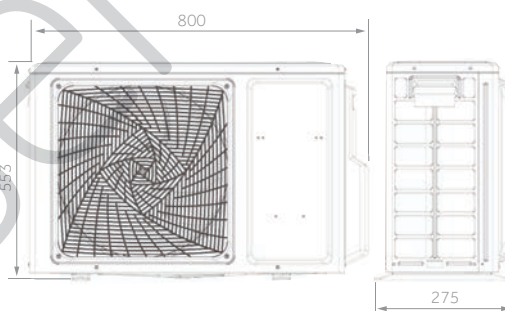

1U50

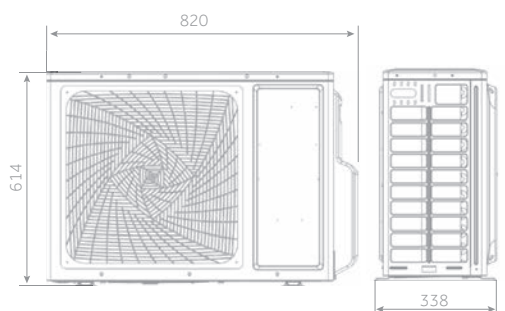

1U71

