 **IntesisBox[®] KNX**
HA-AC-KNX-8/16/64 v1.0

User's Manual

r1 eng
Issue Date: 11/2017

Interface for integration of Haier air conditioners into KNX TP-1 (EIB) control systems.

Compatible with VRF air conditioners line commercialized by Haier.

Application's Program Version: 1.0

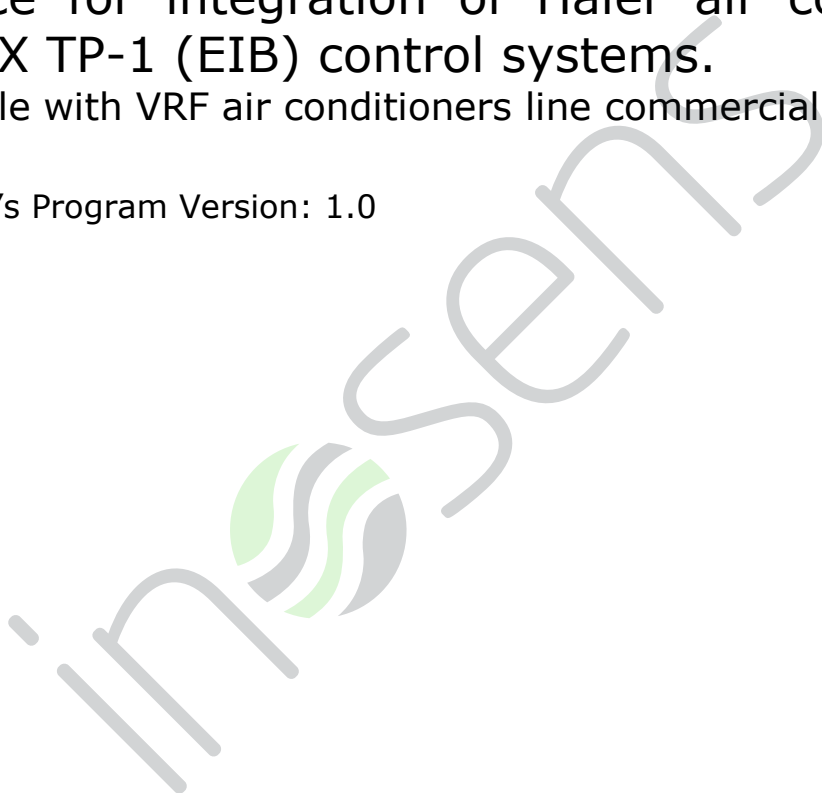

Order Code: **HA-AC-KNX-8**
HA-AC-KNX-16
HA-AC-KNX-64

© Intesis Software S.L.U. 2017 All Rights Reserved.

Information in this document is subject to change without notice. The software described in this document is furnished under a license agreement or nondisclosure agreement. The software may be used only in accordance with the terms of those agreements. No part of this publication may be reproduced, stored in a retrieval system or transmitted in any form or any means electronic or mechanical, including photocopying and recording for any purpose other than the purchaser's personal use without the written permission of Intesis Software S.L.

Intesis Software S.L.U.
Milà i Fontanals, 1 bis
08700 Igualada
Spain

TRADEMARKS

All trademarks and trade names used in this document are acknowledged to be the copyright of their respective holders.

INDEX

1	Presentation.....	5
2	Connection	6
3	Configuration and setup	7
4	ETS Parameters.....	8
4.1	General configuration	9
4.1.1	Download latest database entry for this product and its User Manual from:	9
4.1.2	Intesis Product	9
4.1.3	Number of Indoor Units in ETS	9
4.1.4	First Status Updated to KNX.....	10
4.1.5	Enable object "Error Code [2byte]"	10
4.1.6	Enable object "Error Text Code [14byte]".....	10
4.2	Global mode configuration.....	11
4.2.1	Enable use of "Operating Mode" objects.....	11
4.2.2	Enable use of Mode Heat/Cool objects	11
4.2.3	Enable use of + / - object for Mode.....	12
4.2.4	Enable use of bit-type Mode objects (for control)	12
4.2.5	Enable use of bit-type Mode objects (for status)	13
4.2.6	Enable use of Text object for Mode.....	13
4.3	Global Fan Speed Configuration dialog.....	14
4.3.1	DPT object type for fan speed.....	14
4.3.2	Enable use of "Fan Speed Man/Auto" objects (for Control and Status)	15
4.3.3	Enable use of +/- object for Fan Speed.....	15
4.3.4	Enable use of bit-type Fan Speed objects (for Control)	16
4.3.5	Enable use of bit-type Fan Speed objects (for Status)	17
4.3.6	Enable use of Text object for Fan Speed	17
4.4	Global temperature configuration	18
4.4.1	Enable use of +/- obj for Setpoint.....	18
4.4.2	Ambient Ref. Temp. is provided from KNX.....	18
4.5	Control Mode configuration.....	20
4.5.1	Enable use of Control Mode objects (for Control and Status)	20
4.5.1	Initial state of Control Mode	20
4.6	Addressing of Indoor Units	22
4.7	License	23
5	Technical Specifications.....	24
6	AC Unit Types compatibility.	25
7	Error Codes.....	26
	Appendix A – Communication Objects Table	29

1 Presentation



HA-AC-KNX-8/16/64 allows a complete and natural integration of Haier air conditioners with KNX control systems.

Compatible with all models of VRF line of Haier air conditioners.

Main features:

- Reduced dimensions. Installation even inside the A.C. indoor unit.
- Quick and non-visible installation.
- External power not required.
- Direct connection to the KNX EIB bus.
- Direct connection to the AC indoor unit.
- Fully KNX interoperable, configuration from ETS.
- Multiple objects for control (of different types: bit, byte, characters...).
- Control of the AC unit based in the ambient temperature read by the own AC unit, or in the ambient temperature read by any KNX thermostat.
- Total Control and Monitoring of the AC unit from KNX, including monitoring of AC unit's state of internal variables, running hours counter (for filter maintenance control), and error indication and error code.
- AC unit can be controlled simultaneously by the IR remote control of the AC unit and by KNX.

2 Connection

Connection of the interface to the AC indoor unit:

Disconnect mains power from the AC unit. Open the front cover of the indoor unit in order to have access to the internal control board. In the control board locate the socket connector marked as **ABG1**.

Using a 3-wire cable, connect the **ABG1** connector from the HA-AC-KNX-8/16/64 to the A B G1 connector of the AC unit's control board.

Fix the HA-AC-KNX-8/16/64 inside or outside the AC indoor unit depending on your needs – remember that HA-AC-KNX-8/16/64 must be also connected to the KNX bus. Close the AC indoor unit's front cover again.

Connection of the interface to the KNX bus:

Disconnect power of the KNX bus. Connect the interface to the KNX TP-1 (EIB) bus using the KNX standard connector (red/grey) of the interface, respect polarity. Reconnect power of the KNX bus.

Connections diagram:

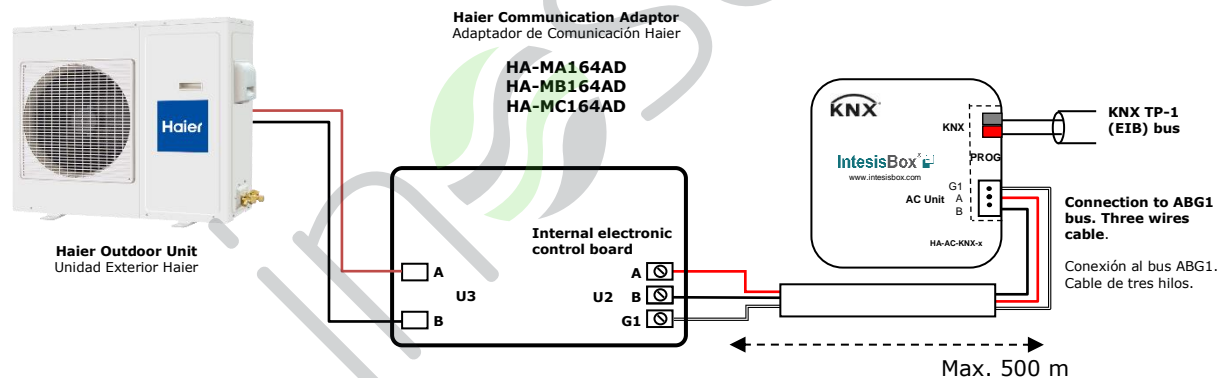

Figure 2.1 Default parameter configuration

Each Haier Communication Adaptor connects to a single Outdoor Unit.

The HA-AC-KNX-8-16-64 can be connected to more than one Haier Communication Adaptor simultaneously.

NOTE: More than one Haier Communication Adaptor can be present in the installation. Please make sure that the address of the Haier Communication Adaptor is correctly set in the ETS. Check section 4.6 for more information.

3 Configuration and setup

This is a fully compatible KNX device which must be configured and setup using standard KNX tool ETS.

ETS project for this device can be downloaded from:

https://www.intesisbox.com/en/haier-knx-ac-ha-ac-knx-8_16_64/gateway/

Please consult the README.txt file, located inside the downloaded zip file, to find instructions on how to install the database.



4 ETS Parameters

When imported to the ETS software for the first time, the gateway shows the following default parameter configuration:

1.1.1 HA AC interface (multiple indoor units) > General configuration	
General configuration	Download latest database entry for this product and its User Manual from: <input type="text" value="http://www.intesisbox.com"/>
Global Mode configuration	Intesis Product: HA-AC-KNX-8
Global Fan Speed configuration	Number of Indoor Units in ETS: 1
Global Temperature configurati...	First Status Update to KNX: ASAP
Control Mode Configuration	Enable object "Error Code [2byte]": <input checked="" type="radio"/> Disabled <input type="radio"/> Enabled
Addressing of Indoor Units	Enable object "Error Text [14byte]" (2 ASCII-char Error Code): <input type="radio"/> Disabled <input checked="" type="radio"/> Enabled
License	

Figure 4.1 Default parameter configuration

With this configuration it's possible to send On/Off (*Control_ On/Off*), change the AC Mode (*Control_ Mode*), the Fan Speed (*Control_ Fan Speed*) and also the Setpoint Temperature (*Control_ Setpoint Temperature*). The Status_ objects, for the mentioned Control_ objects, are also available to use if needed. Objects *Status_ AC Ambient Reference Temperature* and *Status_ Error/Alarm* are shown too.

1.1.1 HA AC interface (multiple indoor units)	
1: AC01 Control_ On/Off [DPT_1.001] - 0-Off;1-On	
3: AC01 Control_ Mode [DPT_20.105] - 0-Aut;1-Hea;3-Coo;9-Fan...	
11: AC01 Control_ Fan Speed [DPT_5.001] - Thresholds: 50% an...	
17: AC01 Control_ Setpoint Temperature [DPT_9.001] - °C	
24: AC01 Status_ On/Off [DPT_1.001] - 0-Off;1-On	
26: AC01 Status_ Mode [DPT_20.105] - 0-Aut;1-Hea;3-Coo;9-Fan...	
34: AC01 Status_ Fan Speed [DPT_5.001] - 33%, 66% and 100%	
40: AC01 Status_ AC Setpoint Temperature [DPT_9.001] - °C	
41: AC01 Status_ AC Ambient Reference Temperature [DPT_9.00...	
42: AC01 Status_ Error/Alarm [DPT_1.005] - 0-No alarm;1-Alarm	
44: AC01 Status_ Error Text [DPT_16.001] - Error Text	

Figure 4.2 Default communication objects

4.1 General configuration

Inside this parameter's dialog it is possible to activate or change the parameters shown in the **Figure 4.1**.

4.1.1 Download latest database entry for this product and its User Manual from:

The first field shows the URL where to download the database and the user manual for the product.

Download latest database entry for this product and its User Manual from:

Figure 4.3 Parameter detail

4.1.2 Intesis Product

This parameter is used to check, before sending the programming, the maximum number of AC units your device supports.

Global Mode configuration | Intesis Product | HA-AC-KNX-8

Figure 4.4 Parameter detail

Select the version of the gateway that you have:

- HA-AC-KNX-8, if you only want to control up to 8 AC unit.
- HA-AC-KNX-16, if you only want to control up to 16 AC units.
- HA-AC-KNX-64, if you only want to control up to 64 AC units.

4.1.3 Number of Indoor Units in ETS

This parameter is used to hide/show communication object according to the number of AC units you need to configure. Value ranges go from 1 to 64.

Number of Indoor Units in ETS

Figure 4.5 Parameter detail

In case you introduce a number higher than the maximum number of units allowed by your license, you will get a warning message. This is just for information and will not block the configuration process. Configurations with more indoor units configured than the ones allowed by the license will not be downloaded correctly.

Intesis Product | HA-AC-KNX-8

Number of Indoor Units in ETS | 9

>> WARNING | Too many Indoor Units for this product!

Figure 4.6 Parameter detail

4.1.4 First Status Updated to KNX

This parameter defines how fast the status is updated to KNX. Depending on the value selected, more or less priority will be assigned to this action. As there are so many parameters available, it is important to consider carefully how to set this parameter.

- If set to **"ASAP"**, all status communication objects will send its value (if needed).
- If set to **"Slow"**, all status communication objects will send its value (if needed), but slower than in the previous option (ASAP).
- If set to **"Super Slow"**, all status communication objects will send its value (if needed), but slower than in the previous option (Slow).

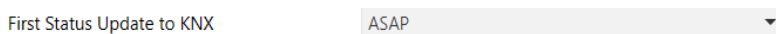

Figure 4.7 Parameter detail

4.1.5 Enable object "Error Code [2byte]"

This parameter shows/hides the *Status_ Error Code* communication object which shows the indoor unit errors, if occurred, in numeric format.

Enable object "Error Code [2byte]" Disabled Enabled

43: AC01 Status_ Error Code [2-byte signed value] - Error Code

Figure 4.8 Communication object and parameter detail

- If set to **"Disabled"** the object will not be shown.
- If set to **"Enabled"** the *Status_ Error Code [2byte signed value]* object will appear.
 - This object can be read and also sends the indoor unit error, if occurred, in numeric format. If a **"0"** value is shown that means no error.

4.1.6 Enable object "Error Text Code [14byte]"

This parameter shows/hides the *Status_ Error Text Code* communication object which shows the indoor unit errors, if occurred, in text format.

Enable object "Error Text [14byte]" Disabled Enabled
(2 ASCII-char Error Code)

44: AC01 Status_ Error Text [DPT_16.001] - Error Text

Figure 4.9 Communication object and parameter detail

- If set to **"Disabled"** the object will not be shown.
- If set to **"Enabled"** the *Status_ Error Text Code* object will appear.

- This object can be read and also sends the indoor unit error, if occurred, in text format. The errors shown have the same format as in the remote controller and in the error list from the indoor unit manufacturer. If the object's value is empty, that means there is no error.

4.2 Global mode configuration

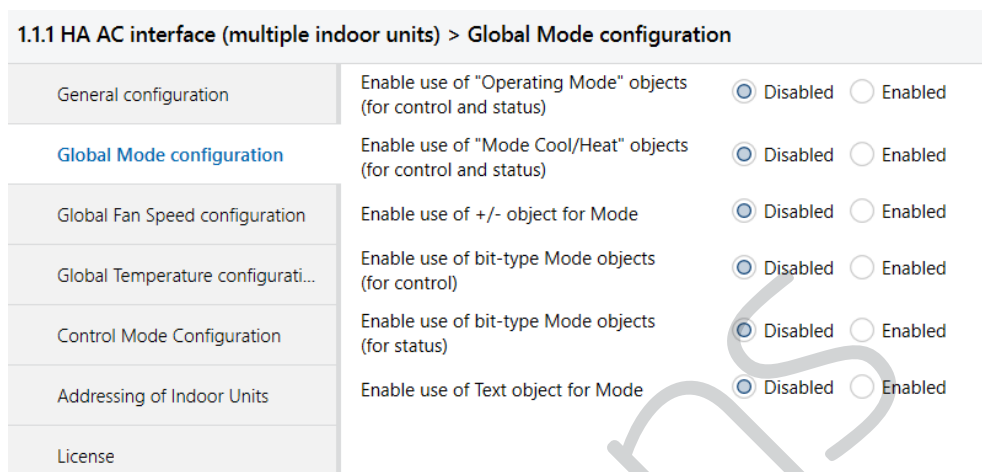

Figure 4.10 Default Mode Configuration dialog

All the parameters in this section are related with the different mode properties and communication objects.

- 3: Control_Mode [DPT_20.105 - 1byte] - 0-Aut;1-Hea;3-Coo;9-Fan;14-Dry
- 26: Status_Mode [DPT_20.105 - 1byte] - 0-Aut;1-Hea;3-Coo;9-Fan;14-Dry

The byte-type communication object for Mode works with the DTP_20.105. Auto mode will be enabled with a "0" value, Heat mode with a "1" value, Cool mode with a "3" value, Fan mode with a "9" value and Dry mode with a "14" value.

4.2.1 Enable use of "Operating Mode" objects

This parameter shows/hides the *Control_* and *Status_ Mode Operating Mode* communication objects.

- 2: Control_Operating Mode [DPT_20.102 - 1byte] - 0-Aut;1-Com;2-Stan;3-Eco;4-Pro
- 25: Status_Operating Mode [DPT_20.102 - 1byte] - 0-Aut;1-Com;2-Stan;3-Eco;4-

4.2.2 Enable use of Mode Heat/Cool objects

This parameter shows/hides the *Control_* and *Status_ Mode Cool/Heat* communication objects.

- 4: Control_Mode Cool/Heat [DPT_1.100 - 1bit] - 0-Cool;1-Heat
- 27: Status_Mode Cool/Heat [DPT_1.100 - 1bit] - 0-Cool;1-Heat

- If set to "Disabled" the objects will not be shown.

- If set to **“Enabled”** the *Control_* and *Status_ Mode Cool/Heat* objects will appear.
 - When a **“1”** value is sent to the *Control_* communication object, **Heat mode** will be enabled in the indoor unit, and the *Status_* object will return this value.
 - When a **“0”** value is sent to the *Control_* communication object, **Cool mode** will be enabled in the indoor unit, and the *Status_* object will return this value.

4.2.3 Enable use of + / - object for Mode

This parameter shows/hides the *Control_ Mode +/-* communication object which let's you change the indoor unit mode by using two different datapoint types.

■ ↕ 10: Control_ Mode +/- [DPT_1.008 - 1bit] - 0-Up;1-Down

- If set to **“Disabled”** the object will not be shown.
- If set to **“Enabled”** the *Control_ Mode +/-* object and a new parameter will appear.

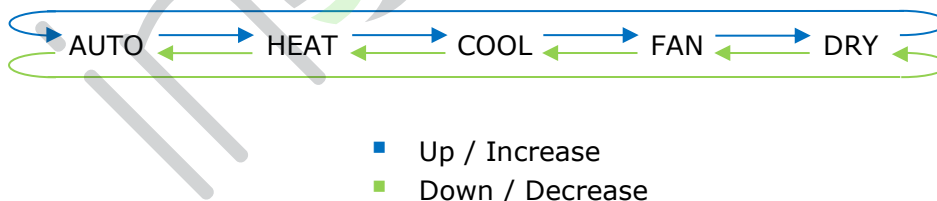

Figure 4.11 Parameter detail

➤ DPT type for +/- Mode Object

This parameter lets choose between the datapoints **0-Up / 1-Down [DPT_1.008]** and **0-Decrease / 1-Increase [DPT_1.007]** for the *Control_ Mode +/-* object.

The sequence followed when using this object is shown below:



Keep in mind that depending on the indoor unit you have and the available features, Auto mode and Dry mode may not be present.

4.2.4 Enable use of bit-type Mode objects (for control)

This parameter shows/hides the bit-type *Control_ Mode* objects.

- ↕ 5: Control_ Mode Auto [DPT_1.002 - 1bit] - 1-Set AUTO operating mode
- ↕ 6: Control_ Mode Heat [DPT_1.002 - 1bit] - 1-Set HEAT operating mode
- ↕ 7: Control_ Mode Cool [DPT_1.002 - 1bit] - 1-Set COOL operating mode
- ↕ 8: Control_ Mode Fan [DPT_1.002 - 1bit] - 1-Set FAN operating mode

▣ 9: Control_Mode Dry [DPT_1.002 - 1bit] - 1-Set DRY operating mode

- If set to **"no"** the objects will not be shown.
- If set to **"yes"** the *Control_Mode* objects for Auto, Heat, Cool, Fan and Dry will appear. To activate a mode by using these objects a **"1"** value has to be sent.

4.2.5 Enable use of bit-type Mode objects (for status)

This parameter shows/hides the bit-type *Status_Mode* objects.

▣ 28: Status_Mode Auto [DPT_1.002 - 1bit] - 1-AUTO is active
 ▣ 29: Status_Mode Heat [DPT_1.002 - 1bit] - 1-HEAT is active
 ▣ 30: Status_Mode Cool [DPT_1.002 - 1bit] - 1-COOL is active
 ▣ 31: Status_Mode Fan [DPT_1.002 - 1bit] - 1-FAN is active
 ▣ 32: Status_Mode Dry [DPT_1.002 - 1bit] - 1-DRY is active

- If set to **"no"** the objects will not be shown.
- If set to **"yes"** the *Status_Mode* objects for Auto, Heat, Cool, Fan and Dry will appear. When enabled, a mode will return a **"1"** through its bit-type object.

4.2.6 Enable use of Text object for Mode

This parameter shows/hides the *Status_Mode Text* communication object.

▣ 33: Status_Mode Text [DPT_16.001 - 14byte] - ASCII String

- If set to **"no"** the object will not be shown.
- If set to **"yes"** the *Status_Mode Text* object will appear. Also, in the parameters, will be shown five text fields, one for each mode, that will let modify the text string displayed by the *Status_Mode Text* when changing mode.

Enable use of Text object for Mode	<input type="radio"/> Disabled <input checked="" type="radio"/> Enabled
> String when mode is AUTO	<input type="text" value="AUTO"/>
> String when mode is HEAT	<input type="text" value="HEAT"/>
> String when mode is COOL	<input type="text" value="COOL"/>
> String when mode is FAN	<input type="text" value="FAN"/>
> String when mode is DRY	<input type="text" value="DRY"/>

Figure 4.12 Parameter detail

4.3 Global Fan Speed Configuration dialog

1.1.1 HA AC interface (multiple indoor units) > Global Fan Speed configuration		
General configuration	DPT object type for fan speed	<input checked="" type="radio"/> Scaling [DPT_5.001] <input type="radio"/> Enumerated [DPT_5.010]
Global Mode configuration	Enable use of "Fan Speed Man/Auto" objects (for control and status)	<input checked="" type="radio"/> Disabled <input type="radio"/> Enabled
Global Fan Speed configurati...	Enable use of +/- object for Fan Speed	<input checked="" type="radio"/> Disabled <input type="radio"/> Enabled
Global Temperature configurati...	Enable use of bit-type Fan Speed objects (for control)	<input checked="" type="radio"/> Disabled <input type="radio"/> Enabled
Control Mode Configuration	Enable use of bit-type Fan Speed objects (for status)	<input checked="" type="radio"/> Disabled <input type="radio"/> Enabled
Addressing of Indoor Units	Enable use of Text object for Fan Speed	<input checked="" type="radio"/> Disabled <input type="radio"/> Enabled
License		

Figure 4.13 Default Fan Speed Configuration dialog

All the parameters in this section are related with the Fan Speed properties and communication objects.

4.3.1 DPT object type for fan speed

With this parameter is possible to change de DPT for the *Control_ Fan Speed* and *Status_ Fan Speed* byte-type communication objects. Datapoints Scaling (DPT_5.001) and Enumerated (DPT_5.010) can be selected.

- When **"Enumerated [DPT 5.010]"** is selected, *Control_ Fan Speed* and *Status_ Fan Speed* communication objects for this DPT will appear. Also, depending on the number of fan speeds selected, these objects will be different.

- 11: AC01 Control_ Fan Speed [DPT_5.010] - Speed values: 1,2,3
- 34: AC01 Status_ Fan Speed [DPT_5.010] - Speed values: 1,2,3

The first fan speed will be selected if a **"1"** is sent to the *Control_* object. The second one will be selected sending a **"2"**, and the last one sending a **"3"**.

The *Status_* object will always return the value for the fan speed selected.

- ▲ **Important:** If a **"0"** value is sent to the *Control_* object, the minimum fan speed will be selected. If a value bigger than **"3"** is sent to the *Control_* object, then the maximum fan speed will be selected.

- When **"Scaling [DPT 5.001]"** is selected, *Control_ Fan Speed* and *Status_ Fan Speed* communication objects for this DPT will appear. Also, depending on the number of fan speeds selected, these objects will be different.

- 11: Control_ Fan Speed / 3 Speeds [DPT_5.001 - 1byte] - Thresholds: 50% and 83%
- 34: Status_ Fan Speed / 3 Speeds [DPT_5.001 - 1byte] - 33%, 66% and 100%

When a value between **0%** and **49%** is sent to the *Control_* object the first fan speed will be selected.

When a value between **50%** and **83%** is sent to the *Control_* object, the second speed will be selected.

When a value between **84%** and **100%** is sent to the *Control_* object, the third speed will be selected.

The *Status_* object will return a **33%** when the first speed is selected, a **67%** for the second one and a **100%** for the third one.

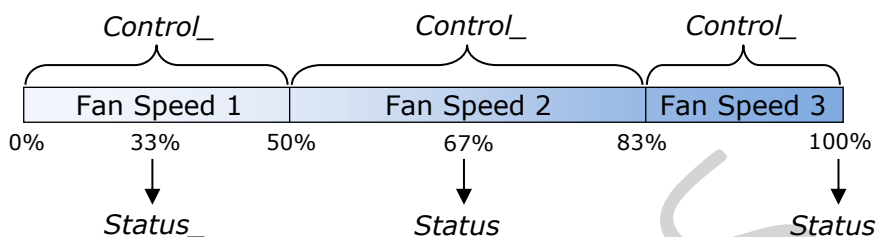

4.3.2 Enable use of "Fan Speed Man/Auto" objects (for Control and Status)

This parameter shows/hides the *Control_ Fan Speed Man/Auto* and *Status_ Fan Speed Man/Auto* communication object which lets you set the Fan Speed into Manual or Auto mode.

- 12: AC01 Control_ Fan Speed Man/Auto [DPT_1.002] - 0-Manual...
- 35: AC01 Status_ Fan Speed Man/Auto [DPT_1.002] - 0-Manual;...

4.3.3 Enable use of +/- object for Fan Speed

This parameter shows/hides the *Control_ Fan Speed +/-* communication object which lets you increase/decrease the indoor unit fan speed by using two different datapoint types.

- 16: Control_ Fan Speed +/- [DPT_1.008 - 1bit] - 0-Up;1-Down

- o If set to "no" the object will not be shown.
- o If set to "yes" the *Control_ Fan Speed +/-* object and a new parameter will appear.

Enable use of +/- object for Fan Speed Disabled Enabled

> Fan speed +/- operation 0-Decrease / 1-Increase [DPT_1.007] 0-Up / 1-Down [DPT_1.008]

> Sequence for +/- object S1 > S2 > ... > SN

Figure 4.14 Parameter detail

➤ Fan speed +/- operation

This parameter lets choose between the datapoints **0-Up / 1-Down [DPT_1.008]** and **0-Decrease / 1-Increase [DPT_1.007]** for the *Control_ Fan Speed +/-* object.

➤ Sequence for +/- object

This parameter lets choose between the different modes available:

Enable use of +/- object for Fan Speed Disabled Enabled

> Fan speed +/- operation 0-Decrease / 1-Increase [DPT_1.007] 0-Up / 1-Down [DPT_1.008]

> Sequence for +/- object S1 > S2 > ... > SN

- **S1>S2>...>SN**
Select this option if you don't have Auto mode and you don't want roll-over to be enabled.
- **S1>S2>...>SN>S1>...**
Select this option if you don't have Auto mode and you want roll-over to be enabled.
- **Auto>S1>S2>...>SN**
Select this option if you have Auto mode and you don't want roll-over to be enabled.
- **Auto>S1>S2>...>SN>Auto>S1>...**
Select this option if you have Auto mode and you want roll-over to be enabled.

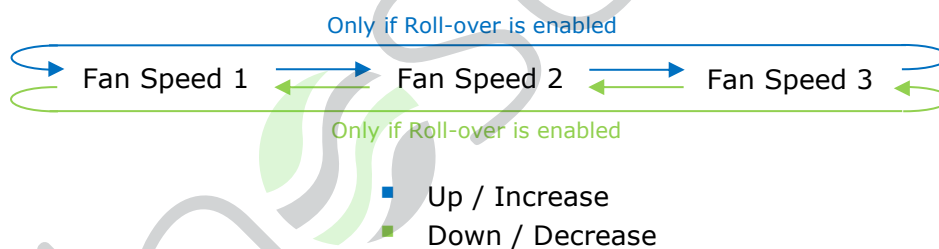

4.3.4 Enable use of bit-type Fan Speed objects (for Control)

This parameter shows/hides the bit-type *Control_ Fan Speed* objects.

- 13: Control_ Fan Speed 1 [DPT_1.002 - 1bit] - 1-Set Fan Speed 1
- 14: Control_ Fan Speed 2 [DPT_1.002 - 1bit] - 1-Set Fan Speed 2
- 15: Control_ Fan Speed 3 [DPT_1.002 - 1bit] - 1-Set Fan Speed 3

- If set to "no" the objects will not be shown.
- If set to "yes" the *Control_ Fan Speed* objects for Speed 1, Speed 2 and Speed 3 (if available) will appear. To activate a Fan Speed by using these objects a "1" value has to be sent.

4.3.5 Enable use of bit-type Fan Speed objects (for Status)

This parameter shows/hides the bit-type *Status_ Fan Speed* objects.

- 36: Status_ Fan Speed 1 [DPT_1.002 - 1bit] - 1-Fan in speed 1
- 37: Status_ Fan Speed 2 [DPT_1.002 - 1bit] - 1-Fan in speed 2
- 38: Status_ Fan Speed 3 [DPT_1.002 - 1bit] - 1-Fan in speed 3

- If set to **"no"** the objects will not be shown.
- If set to **"yes"** the *Status_ Fan Speed* objects for Speed 1, Speed 2 and Speed 3 (if available) will appear. When a Fan Speed is enabled, a **"1"** value is returned through its bit-type object.

4.3.6 Enable use of Text object for Fan Speed

This parameter shows/hides the *Status_ Fan Speed Text* communication object.

- 39: Status_ Fan Speed Text [DPT_16.001 - 14byte] - ascii string

- If set to **"no"** the object will not be shown.
- If set to **"yes"** the *Status_ Fan Speed Text* object will appear. Also, in the parameters, will be shown two (or three, depending on the number of fan speeds selected) text fields, one for each Fan Speed, that will let modify the text string displayed by the *Status_ Fan Speed Text* when changing a fan speed.

Enable use of Text object for Fan Speed Disabled Enabled

> String when fan speed is AUTO	AUTO
> String when fan speed is 1	SPEED 1
> String when fan speed is 2	SPEED 2
> String when fan speed is 3	SPEED 3

Figure 4.15 Parameter detail

4.4 Global temperature configuration

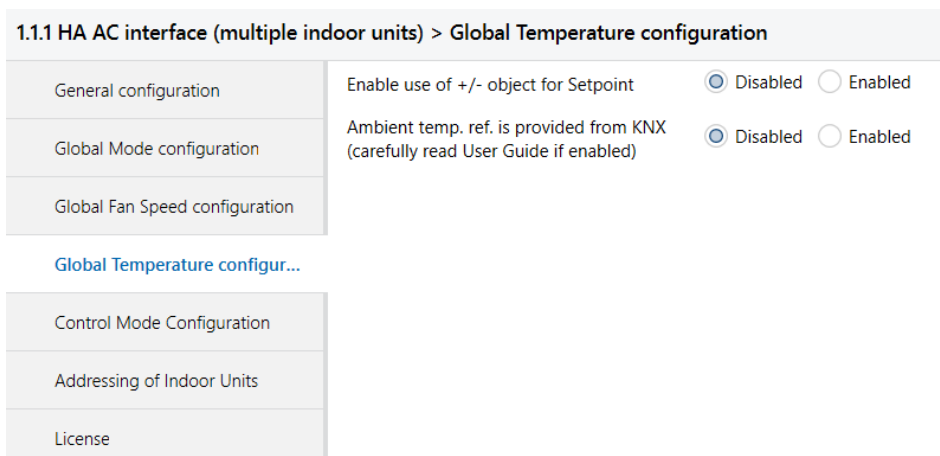

Figure 4.20 Default Temperature Configuration dialog

All the parameters in this section are related with the Temperature properties and communication objects.

4.4.1 Enable use of +/- obj for Setpoint

This parameter shows/hides the *Control_ Setpoint Temp +/-* communication object which lets you change the indoor unit setpoint temperature by using two different datapoint types.

18: Control_ Setpoint Temp +/- [DPT_1.008 - 1bit] - 0-Up;1-Down

- If set to "no" the object will not be shown.
- If set to "yes" the *Control_ Setpoint Temp +/-* object and a new parameter will appear.

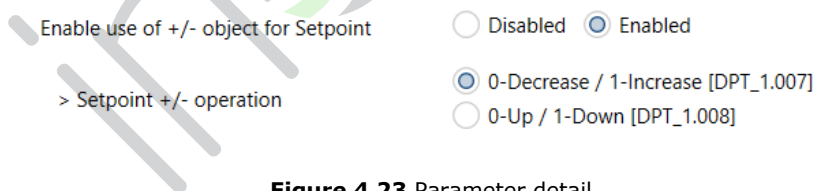

Figure 4.23 Parameter detail

➤ DPT type for +/- Setp Temp object

This parameter lets choose between the datapoints **0-Up / 1-Down [DPT_1.008]** and **0-Decrease / 1-Increase [DPT_1.007]** for the *Control_ Setpoint Temp +/-* object.

(Lower limit) **16°C** → 17°C → ... → 31°C → **32°C** (Upper limit)

- Up / Increase
- Down / Decrease

4.4.2 Ambient Ref. Temp. is provided from KNX

This parameter shows/hides the *Control_ Ambient Temperature* communication object which lets you use an ambient temperature reference provided by a KNX device.

■ 19: Control_ Ambient Temperature [DPT_9.001 - 2byte] - °C

- If set to **"no"** the object will not be shown.
- If set to **"yes"** the *Control_ Ambient Temperature* object will appear. Meant to be enabled when you want the temperature provided by a KNX sensor to be the reference ambient temperature for the air conditioner. Then, the following formula applies for the calculation of real *Control_ Setpoint Temperature* sent to the AC unit:

"AC Setp. Temp" = "Ambient ref. Temp" - ("KNX Amb. Temp." - "KNX Setp Temp.")

- AC Setp. Temp: AC indoor unit setpoint temperature
- Ambient Ref. Temp: AC indoor unit return temperature
- KNX Amb. Temp.: Ambient temperature provided from KNX
- KNX Setp. Temp: Setpoint temperature provided from KNX

As an example, consider the following situation:

User wants: **19°C** ("KNX Setp. Temp.")

User sensor (a KNX sensor) reads: **21°C** ("KNX Amb Temp.")

Ambient temp. read by Haier system is: **24°C** ("Ambient Ref. Temp")

In this example, the final setpoint temperature that HA-AC-KNX-8/16/64 will send out to the indoor unit (shown in "Setp. Temp.") will become 24°C - (21°C - 19°C) = **22°C**. This is the setpoint that will actually be requested to Haier unit.

This formula will be applied as soon as the *Control_ Setpoint Temperature* and *Control_ Ambient Temperature* objects are written at least once from the KNX installation. After that, they are kept always consistent.

Note that this formula will always drive the AC indoor unit demand in the *right* direction, regardless of the operation mode (Heat, Cool or Auto).

4.5 Control Mode configuration

Figure 4.20 Control Mode Configuration dialog

All the parameters in this section are related with the Mode properties and communication objects.

4.5.1 Enable use of Control Mode objects (for Control and Status)

This parameter shows/hides the *Control_ Control Mode and Status_ Control Mode* communication objects which lets you change the indoor unit control: No Central, LIFO (Last Input First Output), Central Controller and Lock Central Controller.

- 20: AC01 Control_ Control Mode No Central [DPT_1.002] - 1-Set...
- 21: AC01 Control_ Control Mode LIFO [DPT_1.002] - 1-Set LIFO...
- 22: AC01 Control_ Control Mode Central [DPT_1.002] - 1-Set CE...
- 23: AC01 Control_ Control Mode Lock [DPT_1.002] - 1-Set LOCK...

- 45: AC01 Status_ Control Mode No Central [DPT_1.002] - 1-NO...
- 46: AC01 Status_ Control Mode LIFO [DPT_1.002] - 1-LIFO mode...
- 47: AC01 Status_ Control Mode Central [DPT_1.002] - 1-CENTRA...
- 48: AC01 Status_ Control Mode Lock [DPT_1.002] - 1-LOCK mod...

- If set to **"no"** the objects will not be shown.
- If set to **"yes"** the *Control_* and *Status_ Control Mode* objects for No Central, LIFO (Last Input First Output), Central Controller, Lock Central Controller will appear.

4.5.1 Initial state of Control Mode

This parameter sets the initial value for the Control Mode: *No Central, LIFO (Last Input First Output), Central Controller, Lock Central Controller or Do not initialize.*

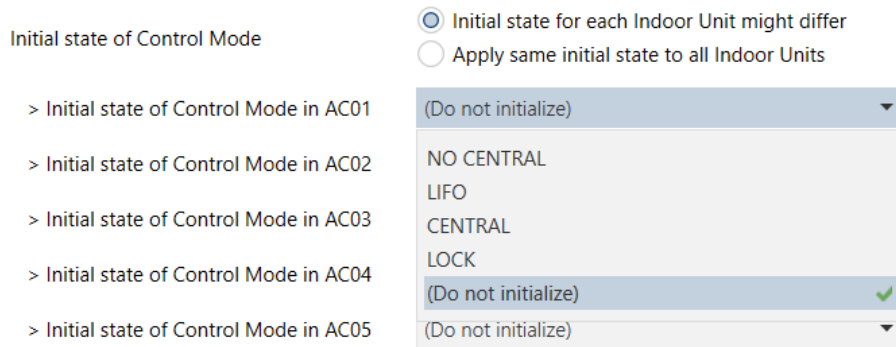
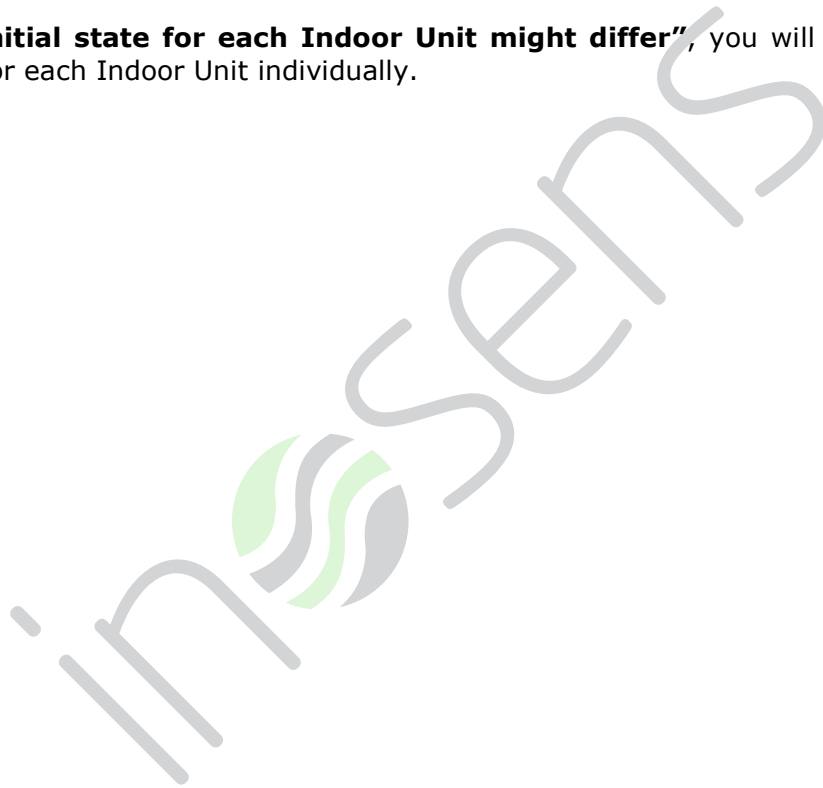

Figure 4.24 Parameter detail

- If set to **“Apply same initial state to all Indoor Units”**, the parameter option selected will apply to all indoor units.
- If set to **“Initial state for each Indoor Unit might differ”**, you will be able to set this parameter for each Indoor Unit individually.



4.6 Addressing of Indoor Units

1.1.1 HA AC interface (multiple indoor units) > Addressing of Indoor Units		
General configuration	----- AC01 -----	
	Modbus GW address of AC01	1
Global Mode configuration	IDU index (in Modbus GW) of AC01	0
Global Fan Speed configuration	----- AC02 -----	
Global Temperature configurati...	Modbus GW address of AC02	1
Control Mode Configuration	IDU index (in Modbus GW) of AC02	1
	----- AC03 -----	
Addressing of Indoor Units	Modbus GW address of AC03	1
License	IDU index (in Modbus GW) of AC03	2
	----- AC04 -----	
	Modbus GW address of AC04	1
	IDU index (in Modbus GW) of AC04	3
	----- AC05 -----	
	Modbus GW address of AC05	1
	IDU index (in Modbus GW) of AC05	4

Figure 4.24 Parameter detail

In this section you will be able to set the AC addressing for each AC unit present in the installation.

- **Modbus GW address of ACxx** refers to the address of the Haier Communication Adapters.
- **IDU index (in Modbus GW) of ACxx** refers to the AC system address of the Indoor Unit.

4.7 License

1.1.1 HA AC interface (multiple indoor units) > License

General configuration	Activation Code	<input type="text"/>
Global Mode configuration		
Global Fan Speed configuration		
Global Temperature configurati...		
Control Mode Configuration		
Addressing of Indoor Units		

[License](#)

Figure 4.24 Parameter detail

Use this section to introduce the migration code in case you need to update your box from another version different from the factory default one.

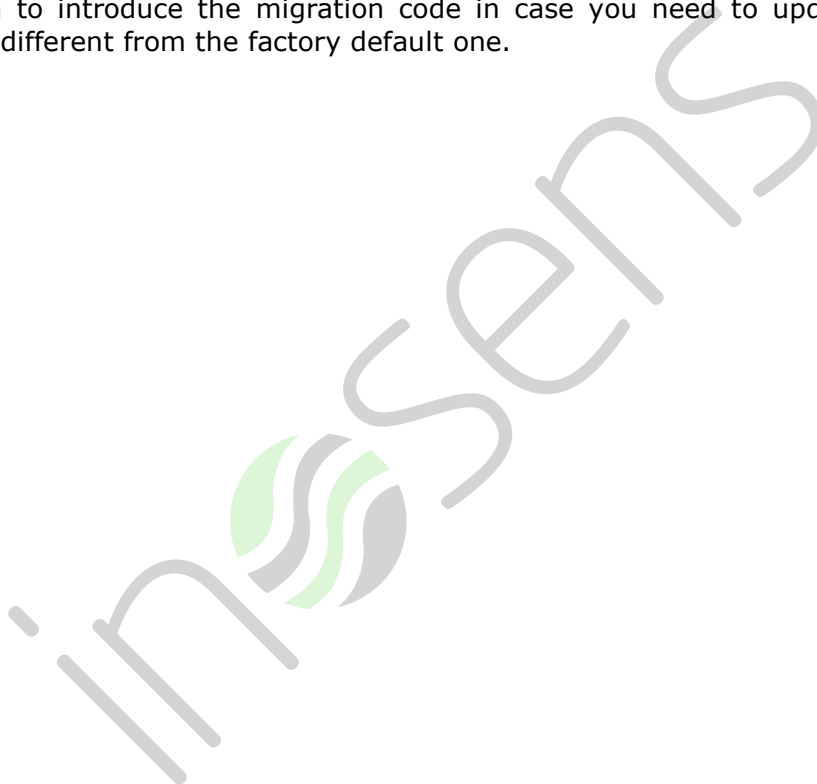

5 Technical Specifications

Enclosure	ABS (UL 94 HB) de 2,5 mm / 1" thick Net dimensions (dxwxh): 70 x 70 x 28 mm / 2.8" x 2.8" x 1.1" Color: Ivory White	Operation Temperature	0°C to +60°C
Weight	42 g.	Stock Temperature	-20°C to +85°C
Power supply	Power is supplied by: 1 x KNX bus (29V DC, 7mA)	Operational Humidity	<90% RH, non-condensing
Terminal Wiring (for low-voltage signals)	For terminal: solid wires or stranded wires (twisted or with ferrule) 1 core: 0.5mm ² ... 2.5mm ² 2 cores: 0.5mm ² ... 1.5mm ² 3 cores: not permitted	Stock Humidity	<90% RH, non-condensing
KNX port	1 x KNX TP1 (EIB) port opto-isolated. Plug-in terminal block (2 poles). TNV-1	Isolation voltage	1500 VDC
AC unit port	1 x Specific connector Plug-in terminal block (3 poles)	Isolation resistance	1000 MΩ
Configuration	Configuration with ETS	Protection	IP20 (IEC60529)
LED indicators	1 x Onboard LED - Operational status		

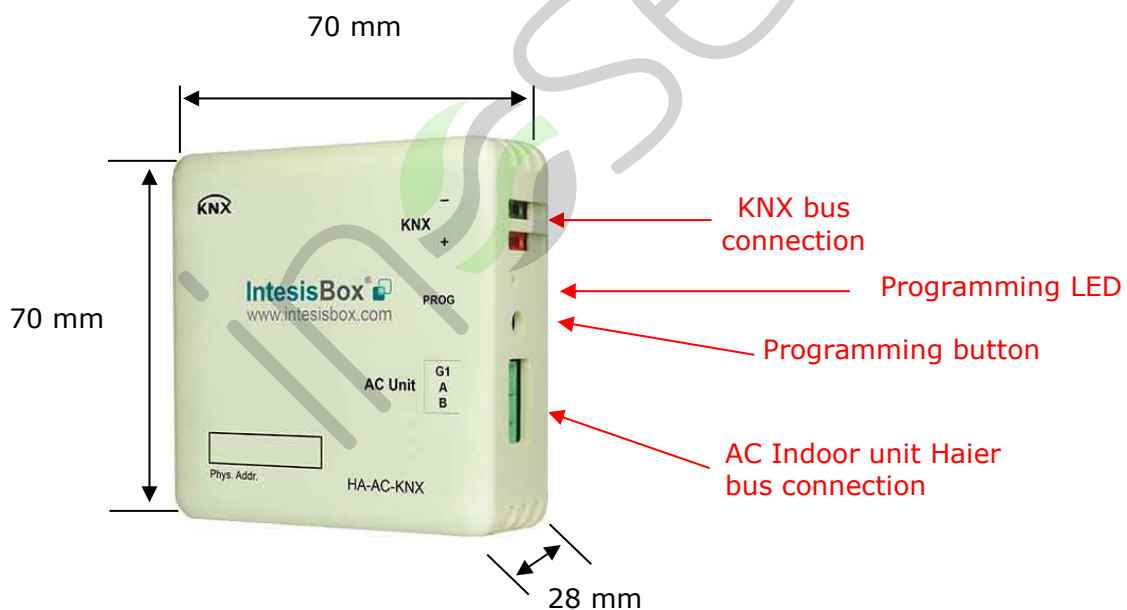

6 AC Unit Types compatibility.

A list of Haier indoor unit model references compatible with HA-AC-KNX-8/16/64 and their available features can be found in:

https://www.intesisbox.com/intesis/support/compatibilities/IntesisBox_HA-AC-xxx-yy_AC_Compatibility.pdf



7 Error Codes

Error Code in KNX Object	Error in Remote Controller	Category	Error Name
1	1	Indoor Unit	Indoor ambient temp.sensor TA (Tas) failure
2	2		Indoor gas pipe temp. sensor TC1 failure
3	3		Indoor liquid pipe temp. sensor TC2 failure
4	4		Dual heat source sensor TW failure
5	5		Indoor EEPROM failure
6	6		Communication between indoor and outdoor failure
7	7		Communication between indoor and wired controller failure
8	8		Indoor float switch failure
9	9		Indoor address repeated failure
10	10		Reserved
11	11		Reserved
12	12		No 50 Hz zero passage signal
13	13		Coil sensor TC3 failure
14	14		DC motor failure
15	15		Indoor ambient temp.sensor TA (Taf) failure
16	16		-
17	17		-
18	18		-
19	19		-
20	20	Outdoor Unit	Defrosting temp. sensor Tdef1 failure
			Defrosting temp. sensor Tdef2 failure
21	21		Ambient temp. sensor Ta failure
22	22		Suction temp. sensor Ts1 failure
			Suction temp. sensor Ts2 failure
			Suction temp. sensor Tsacc failure
			Suction temp. sensor Tsuc failure
23	23		Discharging temp. sensor Tdi failure
			Discharging temp. sensor Td1 failure
			Discharging temp. sensor Td2 failure
24	24		Oil temp. sensor Toilp failure
			Oil temp. sensor Toil failure
25	25		Inlet temp. of heat exchanger Toci1 failure
			Inlet temp. of heat exchanger Toci2 failure
26	26		indoor communication failure
			Reduce the number of indoor units failure
			Increase the number of indoor units failure
27	27		Oil temp. too high protection (Toil)
			Oil temp. too high protection (Toi2)
28	28		High pressure sensor Pd1 failure
			High pressure sensor Pd2 failure
29	29		Low pressure sensor Ps failure
30	30		High pressure switch HPSi failure
			High pressure switch HPS1 failure
		High pressure switch HPS2 failure	
31	31	Liquid pipe pressure PI failure	
32	32	Outlet temp. of subcooler Tsc0 failure	
		Liquid pipe SC temp. of subcooler Tliqsc failure	
33	33	EEPROM (AT24C04) failure	
34	34	Discharging temp. too high protection (Tdi)	
		Discharging temp. too high protection (Td1)	
		Discharging temp. too high protection (Td2)	
35	35	4-way valve reversing failure	
		4-way valve reversing failure	
36	36	Oil temp. too low protection (Toil)	
		Oil temp. too low protection (Toi2)	
37	37	Lack of phase of 3N power supply or wrong phase sequence	
38	38	High pressure sensor Pd too low protection	
39	39	Low pressure sensor Ps too low protection	
		Compression ratio too high protection	
		Compression 1 ratio too low protection	
		Compression 2 ratio too low protection	
40	40	High pressure sensor Pd1 too high protection	
		High pressure sensor Pd2 too high protection	
41	41	Water temp. Twi too low protection	
		Water temp. Twi too high protection	
42	42	Frost protection of water system	
		Water system out of water freeze protection	
		Water flow of Water system is too small to protect	
43	43	Discharging temp. sensor Tdi too low protection	
		Discharging temp. sensor Td1 too low protection	
		Discharging temp. sensor Td2 too low protection	

44	44
45	45
46	46
47	47
48	48
49	49
50	50
51	51
52	52
53	53
54	54
55	55
56	56
57	57
58	58
59	59
60	60
61	61
62	62
63	63
64	64
65	65
66	66
67	67
68	68
69	69
70	70
71	71
72	72
73	73
74	74
75	75
76	76
77	77
78	78
79	79
80	80
81	81
82	82
83	83
84	84
85	85
86	86
87	87
88	88
89	89
90	90
91	91
92	92
93	93
94	94
95	95
96	96
97	97
98	98
99	99
100	100
101	101
102	102
103	103
104	104
105	105
106	106
107	107
108	108
109	109
110	110

Low pressure sensor PS too high protection
Communication among outdoors failure
Communication with inverter board 1 failure
Communication with inverter board 2 failure
-
Unloading valve SV1 failure
-
-
-
Current detector CT1 failure
Communication with Thermal storage module failure
Thermal storage module LEV failure
Thermal storage module too hot failure
Communication between Thermal storage module and host computer
Thermal storage module Tc1 temp. sensor failure
Thermal storage module Tc2 temp. sensor failure
Reserved
Reserved
Reserved
Thermal storage module DIP setting failure
CT1 over current
CT2 over current
-
-
Communication with motor driving board failure
-
-
-
Left DC motor blocked
Right DC motor blocked
Left DC motor reversed
Right DC motor reversed
Left DC motor current too high
Right DC motor current too high
-
No pressure drop between high pressure and low one
Pressure too low between high pressure and low one
Incorrect outdoor address or capacity setting
Oil equalization protection among outdoors
Lack of refrigerant in cooling
Lack of refrigerant in heating
Incorrect wiring
Indoor and outdoor do not match
Model temp. too high protection
Compressor current protection
Wrong model selection
-
-
-
-
-
-
-
-
-
-
-
-
-
-
-
-
-
-
Program self-test failure
DC motor driving board IPM alarm
DC motor driving board detecting out of control
DC motor driving board EEPROM faulty
DC motor driving board over current or current detector damaged
Voltage too low protection of DC motor driving board
Voltage too high protection of DC motor driving board
DC motor driving board blocked
Protection of motor rate over Limitation
-
-
model 1 Over current
model 2 Over current

111	111		Compressor 1 out of control Compressor 2 out of control
112	112		Radiator of model 1 temp. too high Radiator of model 2 temp. too high
113	113		model 1 overload model 2 overload
114	114		Voltage too low of model 1 Voltage too low of model 2
115	115		Voltage too high of model 1 Voltage too high of model 2
116	116		Communication abnormal with model 1 Communication abnormal with model 2
117	117		Model 1 Over current (software) Model 1 Over current (software)
118	118		Model 1 startup failure Model 2 startup failure
119	119		Current Detecting Circuit Abnormal of transducer 1 Current Detecting Circuit Abnormal of transducer 2
120	120		Power supply of transducer 1 abnormal Power supply of transducer 2 abnormal
121	121		Power supply of inverter board 1 is abnormal Power supply of inverter board 2 is abnormal
122	122		Radiator temp. sensor of transducer 1 abnormal Radiator temp. sensor of transducer 2 abnormal
123	123		-
124	124		-
125	125		Compressor 1 frequency not match Compressor 2 frequency not match
126	126		-
127	127		MCU reset abnormal
128	128		MCU Program needs to be upgraded
0	N/A	KNX interface	No error
65535 (-1)	N/A	KNX interface	Indoor Units not ready for communication
65436 (-100)	N/A	KNX interface	License Error / indoor unit not supported by current license
65336 (-200)	N/A	KNX interface	Overconsumption error in EXY bus

In case you detect an error code not listed, contact your nearest Haier technical support service for more information on the error meaning.

Appendix A – Communication Objects Table

SECTION	OBJECT NUMBER	NAME	LENGTH	DATAPOINT TYPE		FLAGS				FUNCTION
				DPT_NAME	DPT_ID	R	W	T	U	
On/Off	1	Control_ On/Off	1 bit	DPT_Switch	1.001		W	T		0 - Off; 1-On
Mode	2	Control_ Operating Mode	1 byte	DPT_HVACMode	20.102		W	T		0 - Auto; 1 - Com; 2 - Stan; 3 - Eco; 4 - Pro
	3	Control_ Mode	1 byte	DPT_HVACControl	20.105		W	T		0 - Auto; 1 - Heat; 3 - Cool; 9 - Fan; 14 - Dry
	4	Control_ Mode Cool/Heat	1 bit	DPT_Cool/Heat	1.100		W	T		0 - Cool; 1 - Heat
	5	Control_ Mode Auto	1 byte	DPT_Scaling	5.001		W	T		1 - Auto
	6	Control_ Mode Heat	1 byte	DPT_Scaling	5.001		W	T		1 - Heat
	7	Control_ Mode Cool	1 bit	DPT_Bool	1.002		W	T		1 - Cool
	8	Control_ Mode Fan	1 bit	DPT_Bool	1.002		W	T		1 - Dry
	9	Control_ Mode Dry	1 bit	DPT_Bool	1.002		W	T		1 - Fan
	10	Control_ Mode +/-	1 bit	DPT_Step	1.007		W			0 - Decrease; 1 - Increase
		Control_ Mode +/-	1 bit	DPT_UpDown	1.008		W			0 - Up; 1 - Down
Fan Speed	11	Control_ Fan Speed / 3 Speeds	1 byte	DPT_Scaling	5.001		W	T		0%-49% - Speed 1; 50%-83% - Speed 2; 84%-100% Speed 3
		Control_ Fan Speed / 3 Speeds	1 byte	DPT_Enumerated	5.010		W	T		1 - Speed 1; 2 - Speed 2; 3 Speed 3
	12	Control_ Fan Speed Man/Auto	1 bit	DPT_Bool	1.002		W	T		0 - Manual; 1 - Auto
	13	Control_ Fan Speed 1	1 bit	DPT_Bool	1.002		W	T		1 - Fan Speed 1
	14	Control_ Fan Speed 2	1 bit	DPT_Bool	1.002		W	T		1 - Fan Speed 2
	15	Control_ Fan Speed 3	1 bit	DPT_Bool	1.002		W	T		1 - Fan Speed 3
	16	Control_ Fan Speed +/-	1 bit	DPT_Step	1.007		W	T		0 - Decrease; 1 - Increase
		Control_ Fan Speed +/-	1 bit	DPT_UpDown	1.008		W	T		0 - Up; 1 - Down

Temperature	17	Control_ Setpoint Temperature	2 byte	DPT_Value_Temp	9.001		W	T	17°C to 30°C
	18	Control_ Setpoint Temp +/-	1 bit	DPT_Step	1.007		W		0 - Decrease; 1 - Increase
		Control_ Setpoint Temp +/-	1 bit	DPT_UpDown	1.008		W		0 - Up; 1 - Down
19	Control_ Ambient Temperature	2 byte	DPT_Value_Temp	9.001		W	T	°C value in EIS5 format	
Control Mode	20	Control_ Control Mode No Central	1 bit	DPT_Bool	1.002		W	T	1 - No Central Controller
	21	Control_ Control Mode LIFO	1 bit	DPT_Bool	1.002		W	T	1 - Last Input First Output (LIFO)
	22	Control_ Control Mode Central	1 bit	DPT_Bool	1.002		W	T	1 - Central Controller
	23	Control_ Control Mode Lock	1 bit	DPT_Bool	1.002		W	T	1 - Lock Central Controller

On/Off	24	Status_ On/Off	1 bit	DPT_Switch	1.001	R		T	0 - Off; 1-On
Mode	25	Status_ Operating Mode	1 byte	DPT_HVACMode	20.102	R		T	0 - Auto; 1 - Com; 2 - Stan; 3 - Eco; 4 - Pro
	26	Status_ Mode	1 byte	DPT_HVACContrMode	20.105	R		T	0 - Auto; 1 - Heat; 3 - Cool; 9 - Fan; 14 - Dry
	27	Status_ Mode Cool/Heat	1 bit	DPT_Heat/Cool	1.100	R		T	0 - Cool; 1 - Heat
	28	Status_ Mode Auto	1 bit	DPT_Bool	1.002	R		T	1 - Auto
	29	Status_ Mode Heat	1 bit	DPT_Bool	1.002	R		T	1 - Heat
	30	Status_ Mode Cool	1 bit	DPT_Bool	1.002	R		T	1 - Cool
	31	Status_ Mode Fan	1 bit	DPT_Bool	1.002	R		T	1 - Fan
	32	Status_ Mode Dry	1 bit	DPT_Bool	1.002	R		T	1 - Dry
	33	Status_ Mode Text	14 byte	DPT_String_8859_1	16.001	R		T	ASCII String
Fan Speed	34	Status_ Fan Speed / 3 Speeds	1 byte	DPT_Scaling	5.001	R		T	33% - Speed 1; 67% - Speed 2; 100% - Speed 3
		Status_ Fan Speed / 3 Speeds	1 byte	DPT_Enumerated	5.010	R		T	1 - Speed 1; 2 - Speed 2; 3 - Speed 3
	35	Status_ Fan Speed Man/Auto	1 bit	DPT_Bool	1.002	R		T	0 - Manual; 1 - Auto

	36	Status_ Fan Speed 1	1 bit	DPT_Bool	1.002	R		T	1 - Speed 1
	37	Status_ Fan Speed 2	1 bit	DPT_Bool	1.002	R		T	1 - Speed 2
	38	Status_ Fan Speed 3	1 bit	DPT_Bool	1.002	R		T	1 - Speed 3
	39	Status_ Fan Speed Text	14 byte	DPT_String_8859_1	16.001	R		T	ASCII String
Temperature	40	Status_ AC Setpoint Temp	2 byte	DPT_Value_Temp	9.001	R		T	16°C to 32°C
	41	Status_ AC Ambient Ref Temp	2 byte	DPT_Value_Temp	9.001	R		T	°C value in EIS5 format
Error	42	Status_ Error/Alarm	1 bit	DTP_Alarm	1.005	R		T	0 - No Alarm; 1 - Alarm
	43	Status_ Error Code	2 byte	Enumerated		R		T	0 - No Error; Any other see user's manual
	44	Status_ Error Text code	14 byte	DPT_String_8859_1	16.001	R		T	2 char Haier Error; Empty - none
Control Mode	45	Control_ Control Mode No Central	1 bit	DPT_Bool	1.002		W	T	1 - No Central Controller
	46	Control_ Control Mode LIFO	1 bit	DPT_Bool	1.002		W	T	1 - Last Input First Output (LIFO)
	47	Control_ Control Mode Central	1 bit	DPT_Bool	1.002		W	T	1 - Central Controller
	48	Control_ Control Mode Lock	1 bit	DPT_Bool	1.002		W	T	1 - Lock Central Controller

NOTE: This addressing corresponds to the first AC indoor unit of the configuration. Communication objects for the rest of AC units are consecutively listed.