

Haier

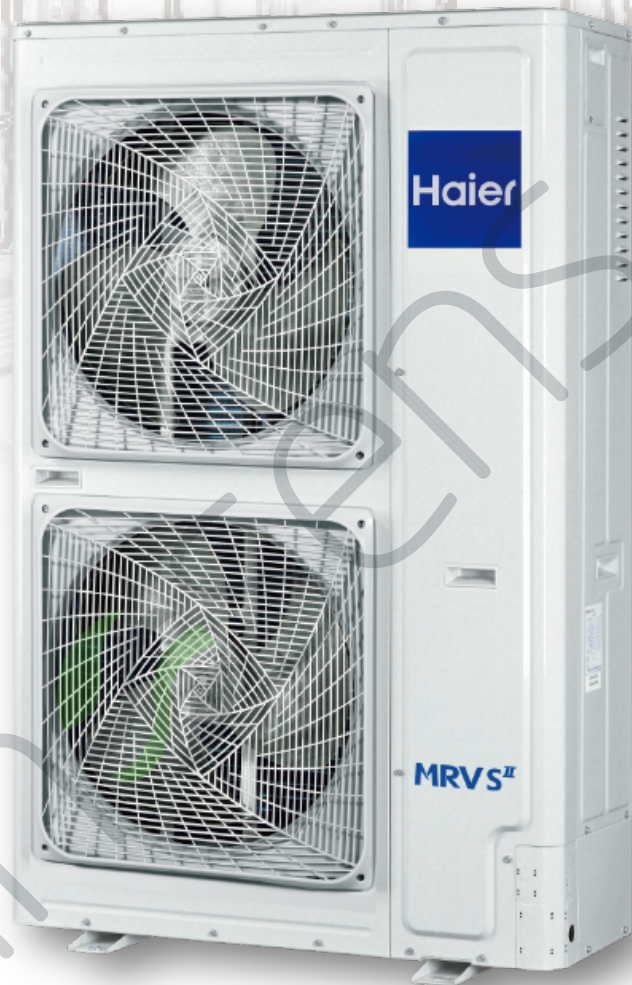

MRV SII

Service Manual

SYJS-06-2021 REV.A

Edition: 2021-06

CONTENTS

1. General Information	1
1.1 Indoor units	1
2. Specification	4
3. Dimension	10
4. Function Parts layout	11
5. Center of gravity	12
6. Refrigerant Circuit	13
7. Wiring Diagram	15
8. Performance Curves	16
9. Selection Procedure	20
10. Operation Range	21
11. Noise Level	22
12. Outdoor Installation	23
12.1 Safety	23
12.2 Installation instruction	25
13. PCB Photo	45
14. Dip Switch Setting	46
15. Outdoor digital tube display setting	47
16. Outdoor Unit Control	54
16.1 Compressor startup control	54
16.2 Compressor output control	54
16.3 Defrosting control	55
16.4 Oil return control	55
17. Failure Code	57
18. Troubleshooting	61

1. General Information

1.1 Indoor units

<p>4-WAY CASSETTE TYPE/PB-700IB</p> <p>AB052MCERA AB072MCERA AB092MCERA AB122MCERA AB162MCERA AB182MCERA(C)</p> 	<p>ROUND-WAY SMART AIR FLOW CASSETTE/ PB-950KB</p> <p>AB072MRERA AB092MRERA AB122MRERA AB162MRERA AB182MRERA</p>  <p>AB242MRERA AB282MRERA</p> <p>AB302MRERA AB382MRERA</p> <p>AB482MRERA AB602MRERA</p>
<p>4-WAY CASSETTE TYPE/PB-950JB</p> <p>AB182MCERA AB242MCERA AB282MCERA</p>  <p>AB302MCERA AB382MCERA AB482MCERA</p> 	<p>ONE WAY CASSETTE TYPE/P1B-1050IB</p> <p>AB052MAERA AB072MAERA AB092MAERA AB122MAERA</p> 
<p>MINI 4-WAY CASSETTE TYPE/PB-620KB</p> <p>AB052MCERA(M) AB072MCERA(M) AB092MCERA(M) AB122MCERA(M) AB162MCERA(M) AB182MCERA(M)</p> 	<p>2-WAY CASSETTE TYPE/ P1B-1055IB</p> <p>AB072MBERA AB092MBERA AB122MBERA AB162MBERA AB182MBERA</p>  <p>LOW ESP DUCT TYPE</p> <p>AD072MLERA AD092MLERA AD122MLERA</p>  <p>AD162MLERA AD182MLERA AD242MLERA</p> 
<p>SLIM LOW ESP DUCT</p> <p>AD072MSERA AD092MSERA AD122MSERA AD162MSERA</p>  <p>AD182MSERA AD242MSERA</p> 	<p>DC SLIM LOW ESP DUCT</p> <p>AD072MSERA(D) AD092MSERA(D) AD122MSERA(D) AD162MSERA(D)</p>  <p>AD182MSERA(D) AD242MSERA(D)</p> 

<p>MED ESP DUCT TYPE (80/120Pa)</p> <p>AD182MZERA AD242MZERA AD282MZERA</p>  <p>AD302MNERA AD382MNERA AD482MNERA</p>	<p>MED ESP DUCT TYPE (50/96Pa)</p> <p>AD182MMERA AD242MMERA AD282MMERA</p>  <p>AD302MMERA AD382MMERA AD482MMERA</p>
<p>MED ESP DUCT TYPE (50/100Pa)</p> <p>AD052MJERA AD072MJERA AD092MJERA AD122MJERA AD162MJERA</p>  <p>AD182MJERA AD242MJERA AD282MJERA</p> <p>AD302MJERA AD382MJERA AD482MJERA</p>	<p>CONSTANT AIR VOLUME DUCT TYPE</p> <p>AD072MQERA AD092MQERA AD122MQERA AD152MQERA AD182MQERA</p>  <p>AD242MQERA AD282MQERA AD302MQERA</p> <p>AD362MQERA AD422MQERA AD482MQERA AD542MQERA</p>
<p>HIGH ESP DUCT TYPE</p> <p>AD182MHERA AD242MHERA AD282MHERA</p>  <p>AD302MHERA AD382MHERA AD482MHERA</p>	<p>CONVERTIBLE TYPE</p> <p>AC092MCERA AC122MCERA AC162MCERA AC182MCERA AC242MCERA</p>  <p>AC282MFERA AC302MFERA AC382MFERA AC482MFERA</p>
<p>EK HIGH WALL</p> <p>AS072MGERA AS092MGERA AS122MGERA AS162MGERA AS182MGERA AS242MGERA</p> 	<p>BUILT-IN FLOOR STANDING</p> <p>AE072MLERA AE092MLERA AE122MLERA AE162MLERA AE182MLERA AE242MLERA</p> 

N HIGH WALL

AS052MNERA
AS072MNERA
AS092MNERA
AS122MNERA



AS052MFERA
AS072MFERA
AS092MFERA
AS122MFERA



AS162MNERA
AS182MNERA
AS242MNERA

AS162MFERA
AS182MFERA
AS242MFERA

AS282MNERA
AS302MNERA

CONSOLE

AF052MAERA
AF072MAERA
AF092MAERA
AF122MAERA
AF182MAERA



NEW CONSOLE

AF052MBERA
AF072MBERA
AF092MBERA
AF122MBERA
AF182MBERA



CONVERTIBLE TYPE (New)

AC092MDERA
AC122MDERA
AC162MDERA
AC182MDERA
AC242MDERA

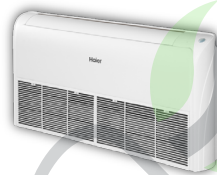

AC282MDERA
AC302MDERA
AC382MDERA
AC482MDERA



2. Specification

Model		AU08NFKERA	
Power supply		Ph/V/Hz	3/380~415/50/60
Cooling	Rated capacity	kW	22.60
	Rated capacity	kBtu/h	77.1
	Rated power input	kW	6.46
	Max. power input	kW	11.5
	EER		3.50
	SEER		8.50
	Rated current	A	10.6
	Max. current	A	19.0
Heating	Rated capacity	kW	22.6
	Rated capacity	kBtu/h	77.1
	Rated power input	kW	5.79
	Max. power input	kW	10.90
	COP		3.90
	SCOP		5.00
	Rated current	A	9.6
	Max. current	A	18.0
Compressor	Brand		Mitsubishi
	Model		LNB65FBEMC
	Type		Rotary
	Compressor quantity		1
	Capacity	W	20100
	Power Input	W	6270
	Rated current(RLA)	A	17.7
	Speed	rps	60
	Crankcase Heater	W	60.0
	Refrigerant oil brand		Itochu.,LTD.,Shanghai
	Refrigerant oil type		FV50S
Refrigerant oil charge	ml	2300	
Outdoor fan motor	Brand		NIDEC/BROAD OCEAN
	Model		SIC-81FW-F1145-1/ZWK511C51504
	Voltage		310
	IP Class		IP44
	Type		DC
	Insulation class		E
	Safe class		I
	Power Input	W	185
	Output	W	145
	Rated current	A	0.84
	Capacitor	μF	/
Speed	rpm	770	
Outdoor fan	Brand		SHUNWEI
	Model		/
	Material		Plastic
	Type		Axial x2
	Diameter	mm	570
	Height	mm	202

Model		AU08NFKERA		
Outdoor coil	Number of rows		2	
	Tube pitch(a)x row pitch(b)	mm	21*18.186	
	Fin spacing	mm	1.45	
	Fin type (code)		Corrugated	
	Fin Coating Type	optional	Hydrophilic aluminum	
	Salt Spray Test Duration	Hour	500	
	Tube outside dia.and type			Internal thread copper tube
		mm		Φ7
	Coil length x height	mm		1122×1584
Number of circuits			12	
Cabinet coating	Coating type		Powder Coating	
	Salt Spray Test Duration	Hour	500	
	Sheet Metal Material		Hot zinc plate	
	Sheet Metal Thickness	mm	1.0	
Control panel enclosure IP class	standard		IP24	
Outdoor air flow	m3/h		10020	
Outdoor sound level(sound pressure level)	dB(A)		63	
Outdoor sound level(sound power level)	dB(A)		76	
Outdoor unit	Dimension(W*H*D)	mm	1050×1636×400	
	Packing (W*H*D)	mm	1150×1795×510	
	Net weight	kg	149	
	Gross weight	kg	168	
Refrigerant	Type		R410A	
	Charged volume	kg	5.1	
Throttle type			EEV	
Design pressure		MPa	4.15	
Refrigerant piping	Liquid pipe	mm	Φ9.52	
	Gas pipe	mm	Φ19.05	
	Total pipe lenth	m	300	
	Max. pipe length(Equivalent/Actual)	m	175/150	
	Max.Diff. indoor/outdoor unit	m	50/40	
	Max.Diff. indoor/indoor unit	m	15	
Connectable indoor unit ratio		%	50-130	
Maximum indoor units		Piece	13	
Connection wiring	Power wiring	mm ²	6	
	Signal wiring	mm ²	shield wire: (0.75-2) *2	
Operation Range		°C	Cooling: -5~48 Heating: -20~27	
Nominal condition: Indoor temperature (cooling): 27 DB(°C)/19 WB(°C), indoor temperature (heating): 20 DB(°C)/14.5 WB(°C). Outdoor temperature (cooling): 35 DB(°C)/24 WB(°C), outdoor temperature (heating): 7 DB(°C)/6 WB(°C). The data is measured with 7.5m equivalent pipe and 0m height difference. The noise level will be measured in the third octave band limited values in the semi-anechoic chamber, using a real time analyser calibrated sound intensity meter. It is a sound pressure noise level.				

Model		AU10NFKERA	
Power supply		Ph/V/Hz	3/380~415/50/60
Cooling	Rated capacity	kW	28.00
	Rated capacity	kBtu/h	95.5
	Rated power input	kW	8.75
	Max. power input	kW	14.4
	EER		3.20
	SEER		8.20
	Rated current	A	14.4
	Max. current	A	23.8
Heating	Rated capacity	kW	30.5
	Rated capacity	kBtu/h	104.1
	Rated power input	kW	8.03
	Max. power input	kW	13.70
	COP		3.80
	SCOP		4.80
	Rated current	A	13.2
	Max. current	A	22.6
Compressor	Brand		Mitsubishi
	Model		LNB65FBEMC
	Type		Rotary
	Compressor quantity		1
	Capacity	W	20100
	Power Input	W	6270
	Rated current(RLA)	A	17.7
	Speed	rps	60
	Crankcase Heater	W	60.0
	Refrigerant oil brand		Itochu.,LTD.,Shanghai
	Refrigerant oil type		FV50S
Refrigerant oil charge	ml	2300	
Outdoor fan motor	Brand		NIDEC/BROAD OCEAN
	Model		SIC-81FW-F1145-1/ZWK511C51504
	Voltage		310
	IP Class		IP44
	Type		DC
	Insulation class		E
	Safe class		I
	Power Input	W	185
	Output	W	145
	Rated current	A	0.84
	Capacitor	μF	/
Speed	rpm	770	
Outdoor fan	Brand		SHUNWEI
	Model		/
	Material		Plastic
	Type		Axial x2
	Diameter	mm	570
	Height	mm	202

Model		AU10NFKERA	
Outdoor coil	Number of rows		2
	Tube pitch(a)x row pitch(b)	mm	21*18.186
	Fin spacing	mm	1.45
	Fin type (code)		Corrugated
	Fin Coating Type	optional	Hydrophilic aluminum
	Salt Spray Test Duration	Hour	500
	Tube outside dia.and type		Internal thread copper tube
		mm	Φ7
	Coil length x height	mm	1122×1584
	Number of circuits		12
Cabinet coating	Coating type		Powder Coating
	Salt Spray Test Duration	Hour	500
	Sheet Metal Material		Hot zinc plate
	Sheet Metal Thickness	mm	1.0
Control panel enclosure IP class		standard	IP24
Outdoor air flow		m3/h	10020
Outdoor sound level(sound pressure level)		dB(A)	64
Outdoor sound level(sound power level)		dB(A)	77
Outdoor unit	Dimension(W*H*D)	mm	1050×1636×400
	Packing (W*H*D)	mm	1150×1795×510
	Net weight	kg	149
	Gross weight	kg	168
Refrigerant	Type		R410A
	Charged volume	kg	5.1
Throttle type			EEV
Design pressure		MPa	4.15
Refrigerant piping	Liquid pipe	mm	Φ9.52
	Gas pipe	mm	Φ22.22
	Total pipe lenth	m	300
	Max. pipe length(Equivalent/ Actual)	m	175/150
	Max.Diff. indoor/outdoor unit	m	"50 40"
	Max.Diff. indoor/indoor unit	m	15
Connectable indoor unit ratio		%	50-130
Maximum indoor units		Piece	16
Connection wiring	Power wiring	mm ²	10
	Signal wiring	mm ²	shield wire: (0.75-2) *2
Operation Range		°C	Cooling: -5~48 Heating: -20~27
<p>Nominal condition: Indoor temperature (cooling): 27 DB(°C)/19 WB(°C), indoor temperature (heating): 20 DB(°C)/14.5 WB(°C). Outdoor temperature (cooling): 35 DB(°C)/24 WB(°C), outdoor temperature (heating): 7 DB(°C)/6 WB(°C). The data is measured with 7.5m equivalent pipe and 0m height difference. The noise level will be measured in the third octave band limited values in the semi-anechoic chamber, using a real time analyser calibrated sound intensity meter. It is a sound pressure noise level.</p>			

Model		AU12NFKERA	
Power supply		Ph/V/Hz	3/380~415/50/60
Cooling	Rated capacity	kW	31.50
	Rated capacity	kBtu/h	107.5
	Rated power input	kW	10.16
	Max. power input	kW	15.4
	EER		3.10
	SEER		7.70
	Rated current	A	16.8
	Max. current	A	25.4
Heating	Rated capacity	kW	31.5
	Rated capacity	kBtu/h	107.5
	Rated power input	kW	8.51
	Max. power input	kW	14.60
	COP		3.70
	SCOP		4.70
	Rated current	A	14.1
	Max. current	A	24.2
Compressor	Brand		Mitsubishi
	Model		LNB65FBEMC
	Type		Rotary
	Compressor quantity		1
	Capacity	W	20100
	Power Input	W	6270
	Rated current(RLA)	A	17.7
	Speed	rps	60
	Crankcase Heater	W	60.0
	Refrigerant oil brand		Itochu.,LTD.,Shanghai
	Refrigerant oil type		FV50S
	Refrigerant oil charge	ml	2300
Outdoor fan motor	Brand		NIDEC/BROAD OCEAN
	Model		SIC-81FW-F1145-1/ZWK511C51504
	Voltage		310
	IP Class		IP44
	Type		DC
	Insulation class		E
	Safe class		I
	Power Input	W	185
	Output	W	145
	Rated current	A	0.84
	Capacitor	μF	/
	Speed	rpm	770
Outdoor fan	Brand		SHUNWEI
	Model		/
	Material		Plastic
	Type		Axial x2
	Diameter	mm	570
	Height	mm	202

Model		AU12NFKERA	
Outdoor coil	Number of rows		2
	Tube pitch(a)x row pitch(b)	mm	21*18.186
	Fin spacing	mm	1.45
	Fin type (code)		Corrugated
	Fin Coating Type	optional	Hydrophilic aluminum
	Salt Spray Test Duration	Hour	500
	Tube outside dia.and type		Internal thread copper tube
		mm	Φ7
	Coil length x height	mm	1122×1584
	Number of circuits		12
Cabinet coating	Coating type		Powder Coating
	Salt Spray Test Duration	Hour	500
	Sheet Metal Material		Hot zinc plate
	Sheet Metal Thickness	mm	1.0
Control panel enclosure IP class		standard	IP24
Outdoor air flow		m3/h	10020
Outdoor sound level(sound pressure level)		dB(A)	65
Outdoor sound level(sound power level)		dB(A)	78
Outdoor unit	Dimension(W*H*D)	mm	1050×1636×400
	Packing (W*H*D)	mm	1150×1795×510
	Net weight	kg	149
	Gross weight	kg	168
Refrigerant	Type		R410A
	Charged volume	kg	5.1
Throttle type			EEV
Design pressure		MPa	4.15
Refrigerant piping	Liquid pipe	mm	Φ12.7
	Gas pipe	mm	Φ25.4
	Total pipe lenth	m	300
	Max. pipe length(Equivalent/ Actual)	m	175/150
	Max.Diff. indoor/outdoor unit	m	50/40
	Max.Diff. indoor/indoor unit	m	15
Connectable indoor unit ratio		%	50-130
Maximum indoor units		Piece	19
Connection wiring	Power wiring	mm ²	10
	Signal wiring	mm ²	shield wire: (0.75-2) *2
Operation Range		°C	Cooling: -5~48 Heating: -20~27
<p>Nominal condition:</p> <p>Indoor temperature (cooling): 27 DB(°C)/19 WB(°C), indoor temperature (heating): 20 DB(°C)/14.5 WB(°C). Outdoor temperature (cooling): 35 DB(°C)/24 WB(°C), outdoor temperature (heating): 7 DB(°C)/6 WB(°C). The data is measured with 7.5m equivalent pipe and 0m height difference. The noise level will be measured in the third octave band limited values in the semi-anechoic chamber, using a real time analyser calibrated sound intensity meter. It is a sound pressure noise level.</p>			

3. Dimension

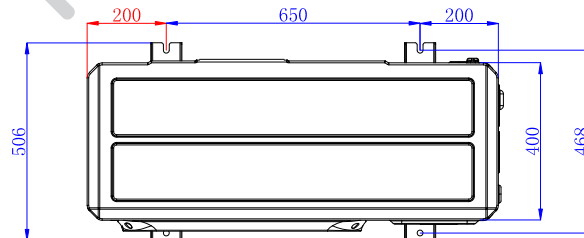
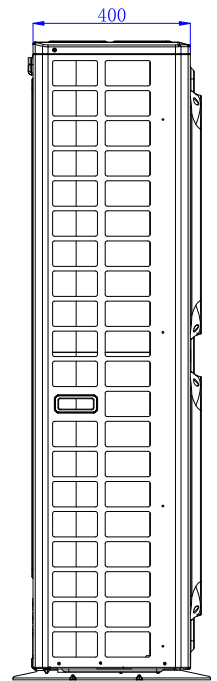
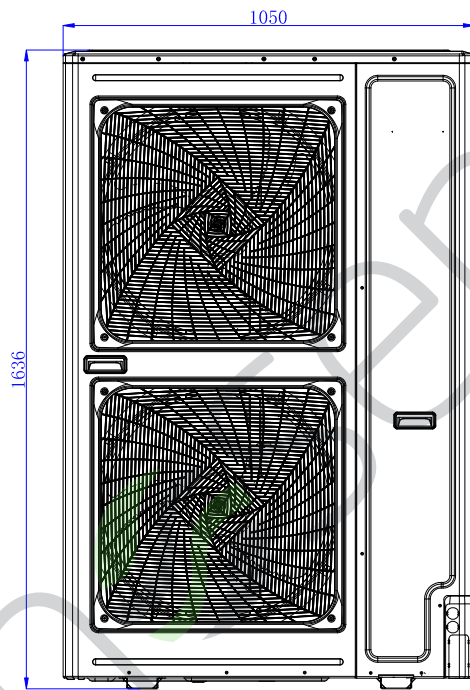
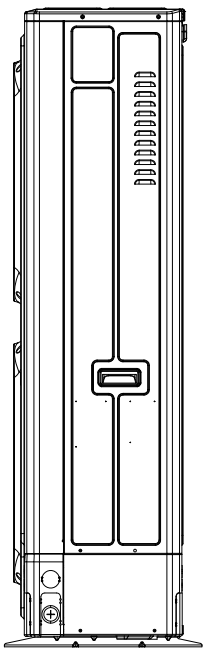
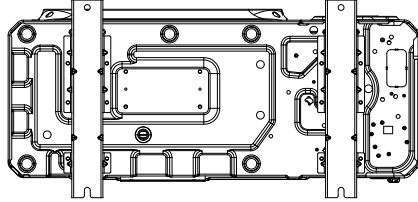

4. Function Parts layout

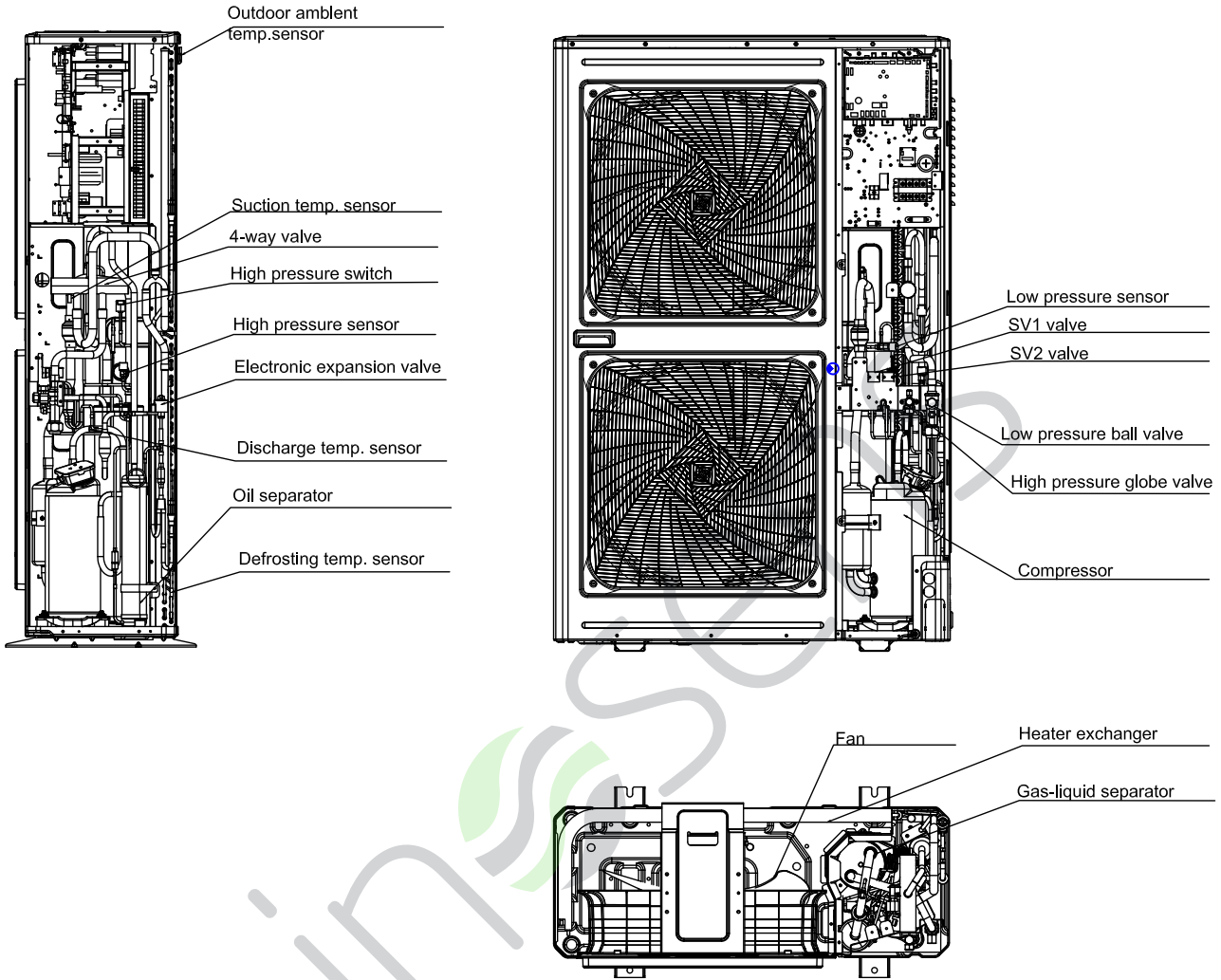

5. Center of gravity

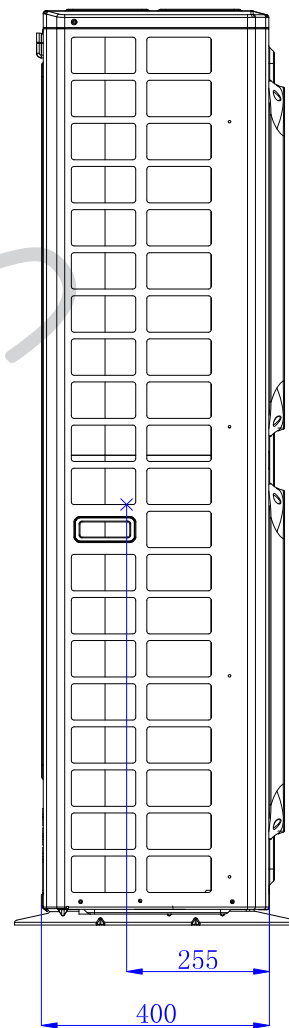
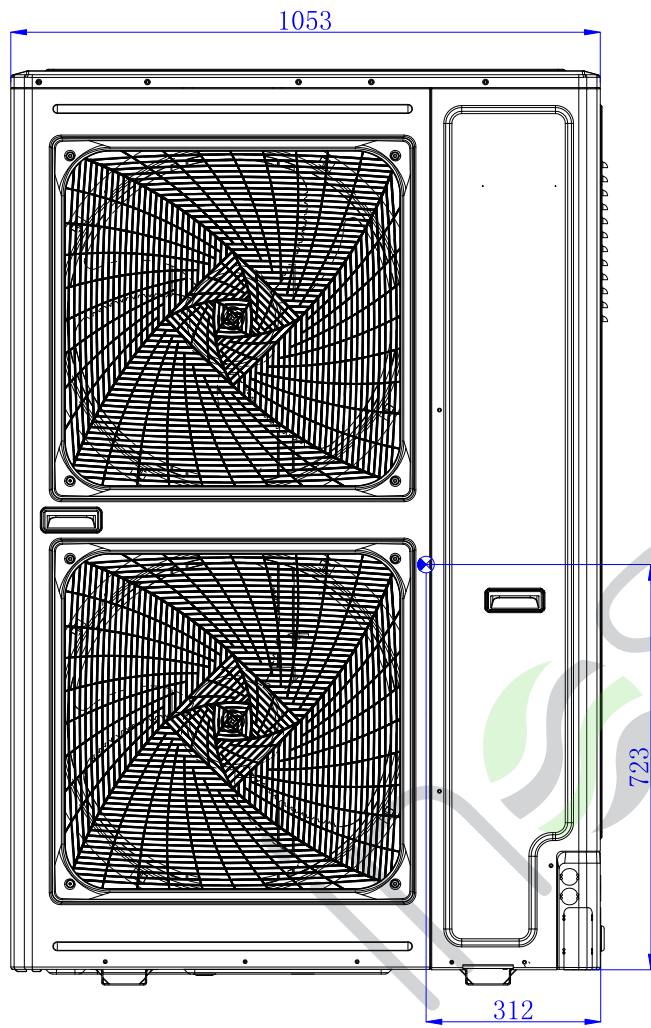

6. Refrigerant Circuit

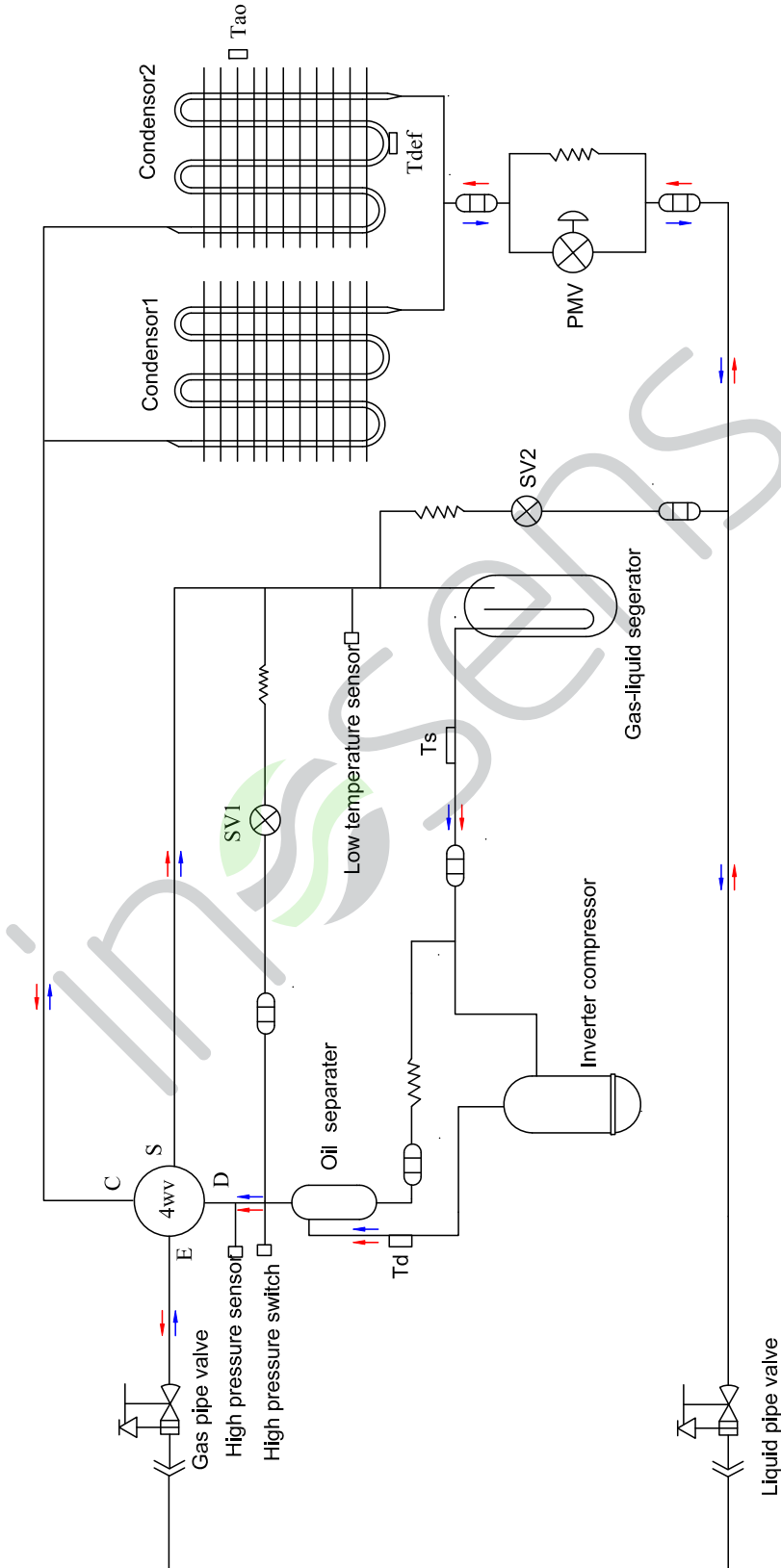

Part name	Sign	Function	Date	Note
Compressor	/	Capacity control, meet indoor load request by adjusting frequency and opening and closing fixing frequency compressor.		20°C
Pressure switch	HPS	High pressure protection	4.15Mpa, OFF	
	LPS	In cooling, compressor frequency adjustment and protection control for abnormal pressure.	0~1.7MPa	
Electronic expansion valve	EEV	In heating, refrigerant flow control (subcooling valve)	Φ3.0	
Solenoid valve	SV1	1. Keep balance of high/low pressure when compressor starts up and stops 2. High/low pressure protection	AC220V Open when power is on, close when power is off.	2A
4-way valve	4WV	Changing over between cooling and heating	AC220V electrified in heating; powered off in cooling or defrosting.	
Temp. sensor	Td	Detect the top temp. of compressor	R(80°C)=50K B(25/80°C)=4450K	
	Ts	Detect the top suction of compressor		
	Tao	Detect ambient temp., set primary fan speed and control defrost condition	R(80°C)=10K B(25/80°C)=3700K	
	Tdef	Detect frost condition of outdoor heat exchanger		

8. Performance Curves

(1) Calculation method of cooling capacity

---cooling capacity to be known = cooling capacity*(A*B*C*D*E) W

A. Capacity compensation value of indoor air wet-bulb temperature condition

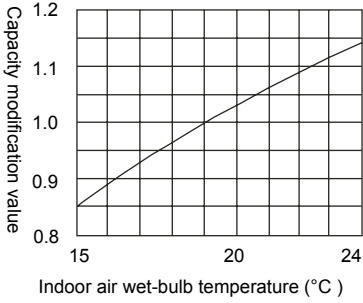

B. Capacity compensation value of outdoor air dry-bulb temperature condition

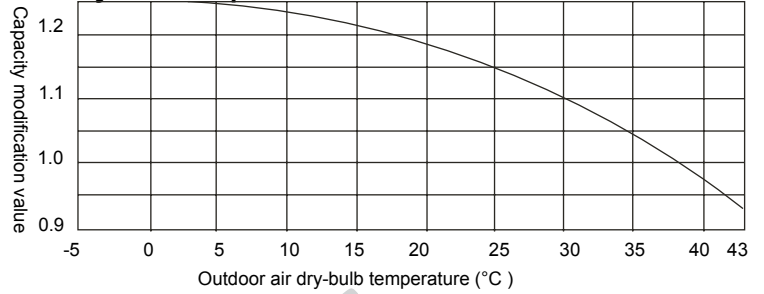

C. Capacity modification value under airflow variation rate of indoor unit group (only for duct unit)

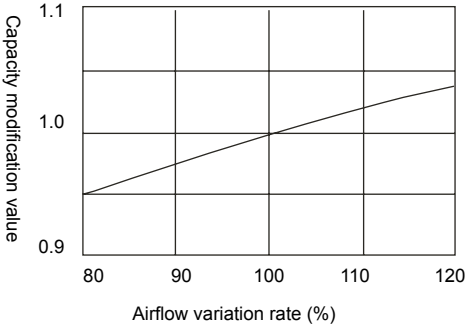

D. Capacity compensation suitable for total capability of indoor unit group

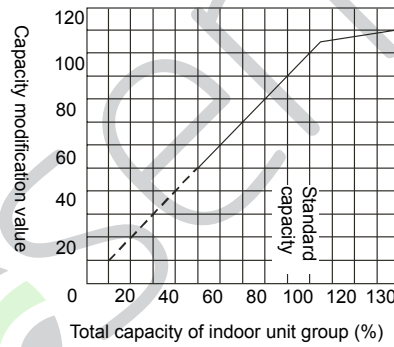

E. Capacity compensation value of pipe length, pipe diameter and height drop

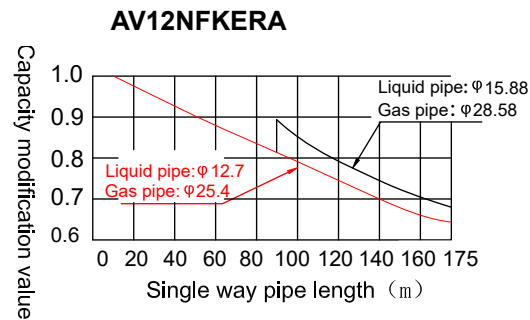
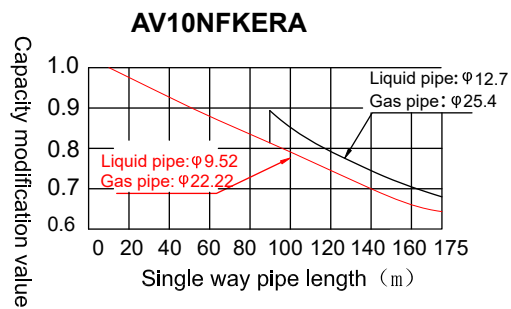
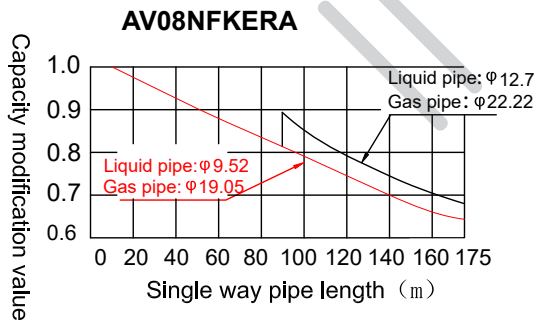

Notes for E:

(1) The main pipe (from outdoor to the first branch pipe) diameter should be enlarged one size when the single way pipe length is over 90m.

(2) When in cooling mode, outdoor is lower than indoor; or when in heating mode, outdoor is higher than indoor, the compensation factor should be decreased the below value from figure E.

Vertical height drop between indoor and outdoor	5m	10m	15m	20m	25m	30m	35m	40m	45m	50m
Adjustment factor	0.003	0.006	0.009	0.012	0.015	0.018	0.021	0.024	0.027	0.030

(2) Calculation method of heating capacity

----heating capacity to be known = heating capacity*(A*B*C*D*E*F) W

A. Capacity compensation value of indoor air dry-bulb temperature condition

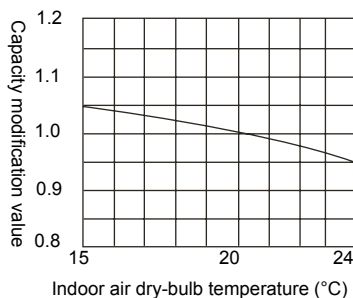

B. Capacity compensation value of outdoor air wet-bulb temperature condition

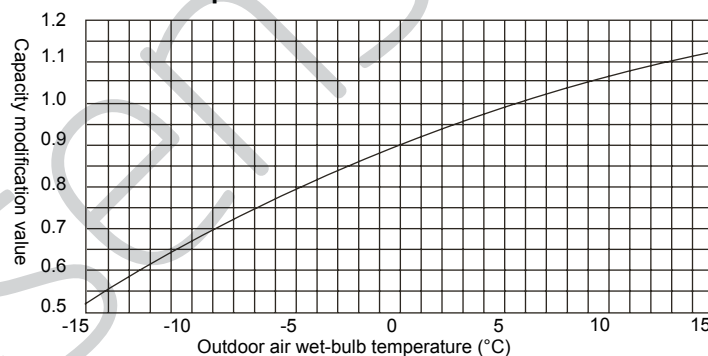

C. Capacity modification value under airflow variation rate of indoor unit group (only for duct unit)

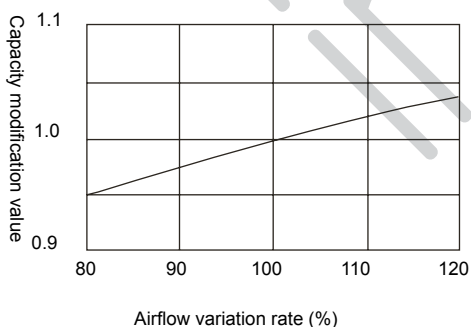

D. Capacity compensation suitable for total capability of indoor unit group

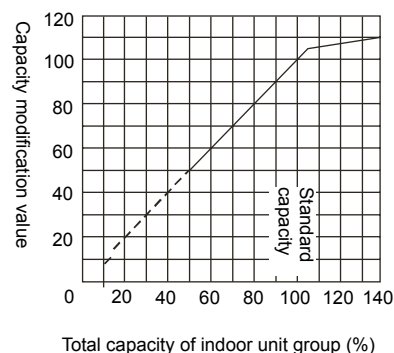

E. Capacity compensation value of pipe length, pipe diameter and height drop

AV08NFKERA

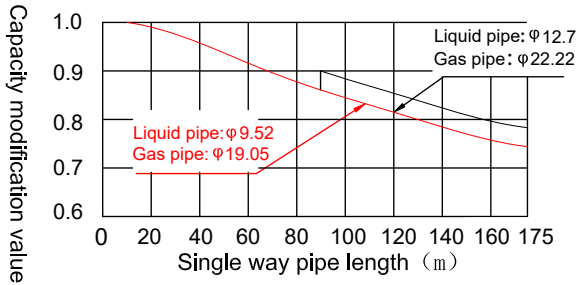

AV10NFKERA

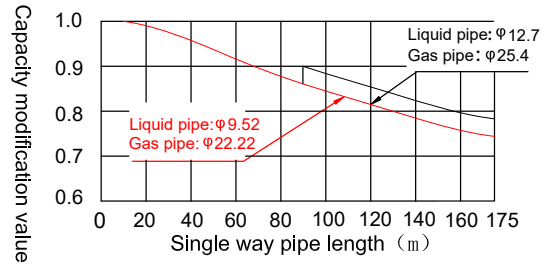

AV12NFKERA

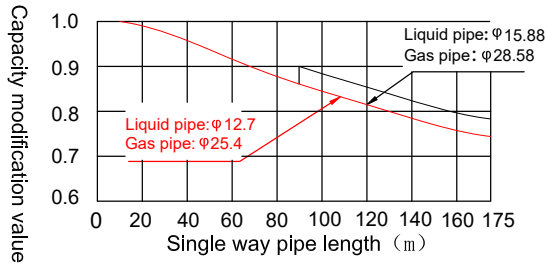

F. Capacity compensation value for defrost capability of outdoor heat exchanger

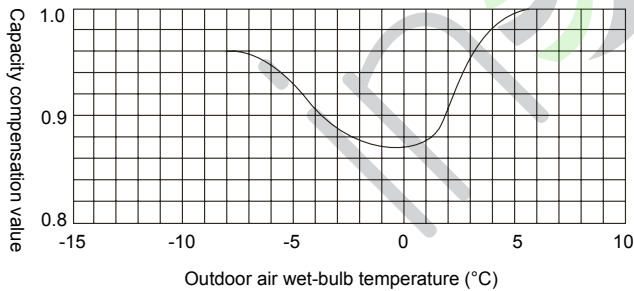

Notes for E:

(1) The main pipe (from outdoor to the first branch pipe) diameter should be enlarged one size when the single way pipe length is over 90m.

(2) When in cooling mode, outdoor is lower than indoor; or when in heating mode, outdoor is higher than indoor, the compensation factor should be decreased the below value from figure E.

Vertical height drop between indoor and outdoor	5m	10m	15m	20m	25m	30m	35m	40m	45m	50m
Adjustment factor	0.003	0.006	0.009	0.012	0.015	0.018	0.021	0.024	0.027	0.030

(1) Correction factor for pipe length and drop.

In cooling

Drop (m)	Single pipe length from the farthest outdoor unit to the farthest indoor unit(m)																	
	0	10	20	30	40	50	60	70	80	90	100	110	120	130	140	150	160	175
50.0	0	0	0	0	0	0.902	0.881	0.86	0.838	0.815	0.792	0.77	0.748	0.726	0.719	0.698	0.669	0.650
40.0	0	0	0	0	0.93	0.902	0.881	0.86	0.838	0.815	0.792	0.77	0.748	0.726	0.719	0.698	0.669	0.650
30.0	0	0	0	0.95	0.93	0.902	0.881	0.86	0.838	0.815	0.792	0.77	0.748	0.726	0.719	0.698	0.669	0.650
20.0	0	0	0.97	0.95	0.93	0.902	0.881	0.86	0.838	0.815	0.792	0.77	0.748	0.726	0.719	0.698	0.669	0.650
10.0	0	0.99	0.97	0.95	0.93	0.902	0.881	0.86	0.838	0.815	0.792	0.77	0.748	0.726	0.719	0.698	0.669	0.650
0.0	1	0.99	0.97	0.95	0.93	0.902	0.881	0.86	0.838	0.815	0.792	0.77	0.748	0.726	0.704	0.682	0.660	0.650
-10.0	0	0.982	0.965	0.942	0.921	0.898	0.875	0.852	0.832	0.81	0.788	0.768	0.748	0.728	0.703	0.678	0.652	0.638
-20.0	0	0	0.96	0.938	0.915	0.892	0.871	0.85	0.828	0.806	0.782	0.76	0.738	0.716	0.701	0.675	0.644	0.625
-30.0	0	0	0	0.931	0.907	0.887	0.866	0.844	0.823	0.801	0.777	0.756	0.735	0.713	0.700	0.671	0.635	0.613
-40.0	0	0	0	0	0.900	0.882	0.861	0.839	0.818	0.797	0.772	0.751	0.730	0.708	0.698	0.668	0.627	0.600

In heating

Drop (m)	Single pipe length from the farthest outdoor unit to the farthest indoor unit(m)																	
	0	10	20	30	40	50	60	70	80	90	100	110	120	130	140	150	160	175
50.0	0	0	0	0	0	0.900	0.883	0.867	0.846	0.824	0.803	0.782	0.761	0.740	0.718	0.696	0.673	0.651
40.0	0	0	0	0	0.914	0.906	0.890	0.873	0.853	0.833	0.813	0.792	0.772	0.752	0.733	0.712	0.690	0.669
30.0	0	0	0	0.929	0.921	0.911	0.896	0.880	0.861	0.841	0.822	0.803	0.783	0.764	0.748	0.728	0.706	0.687
20.0	0	0	0.943	0.938	0.929	0.917	0.902	0.887	0.868	0.850	0.831	0.813	0.794	0.776	0.764	0.745	0.722	0.704
10.0	0	0.957	0.957	0.948	0.936	0.923	0.908	0.893	0.876	0.858	0.841	0.823	0.806	0.788	0.779	0.761	0.739	0.722
0.0	1	0.986	0.971	0.957	0.943	0.929	0.914	0.900	0.883	0.867	0.850	0.833	0.817	0.800	0.794	0.778	0.755	0.740
-10.0	0	0.986	0.971	0.957	0.943	0.929	0.914	0.900	0.883	0.867	0.850	0.833	0.817	0.800	0.794	0.778	0.755	0.740
-20.0	0	0	0.971	0.957	0.943	0.929	0.914	0.900	0.883	0.867	0.850	0.833	0.817	0.800	0.794	0.778	0.755	0.740
-30.0	0	0	0	0.957	0.943	0.929	0.914	0.900	0.883	0.867	0.850	0.833	0.817	0.800	0.794	0.778	0.755	0.740
-40.0	0	0	0	0	0.943	0.929	0.914	0.900	0.883	0.867	0.850	0.833	0.817	0.800	0.794	0.778	0.755	0.740

9. Selection Procedure

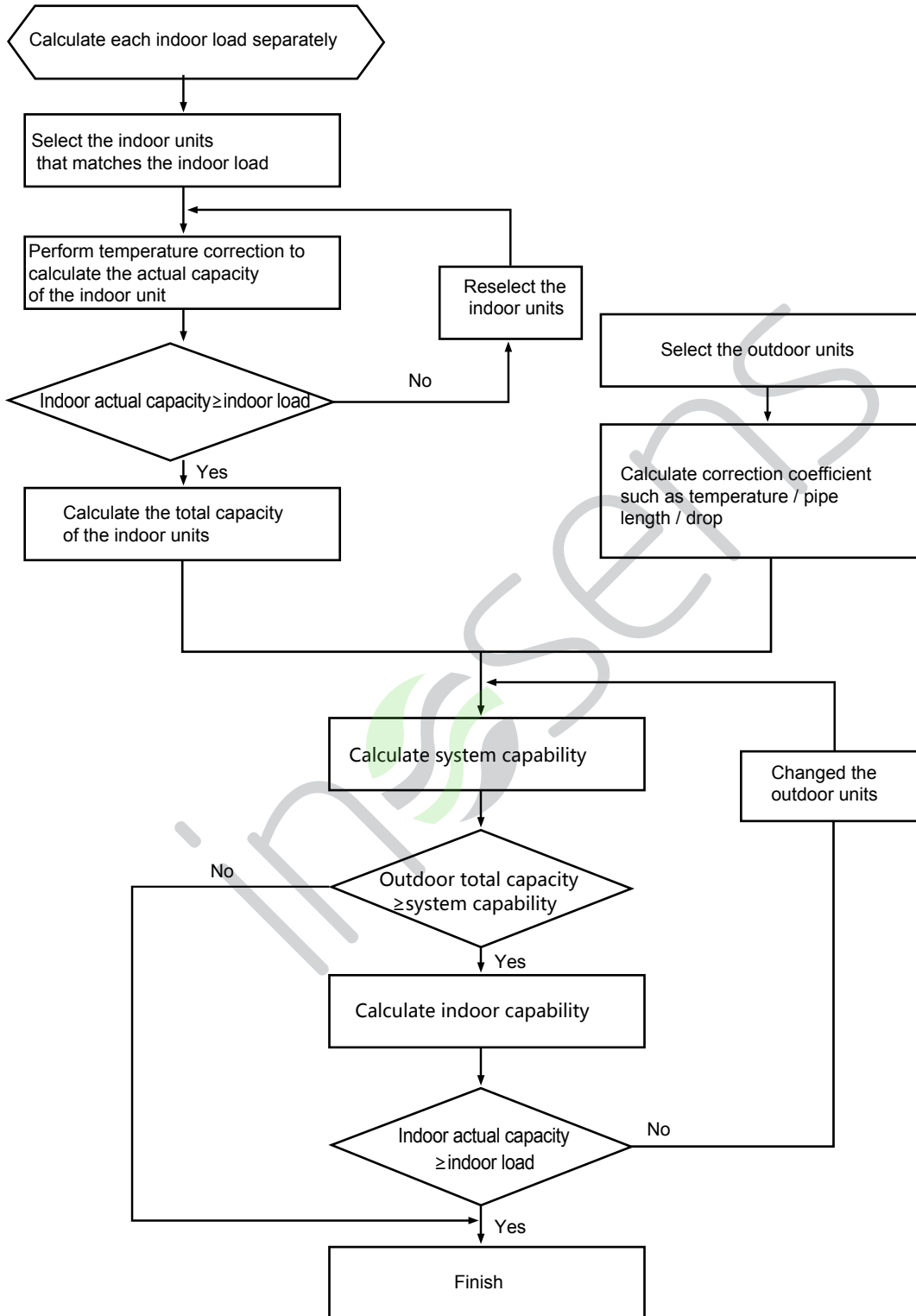

10. Operation Range

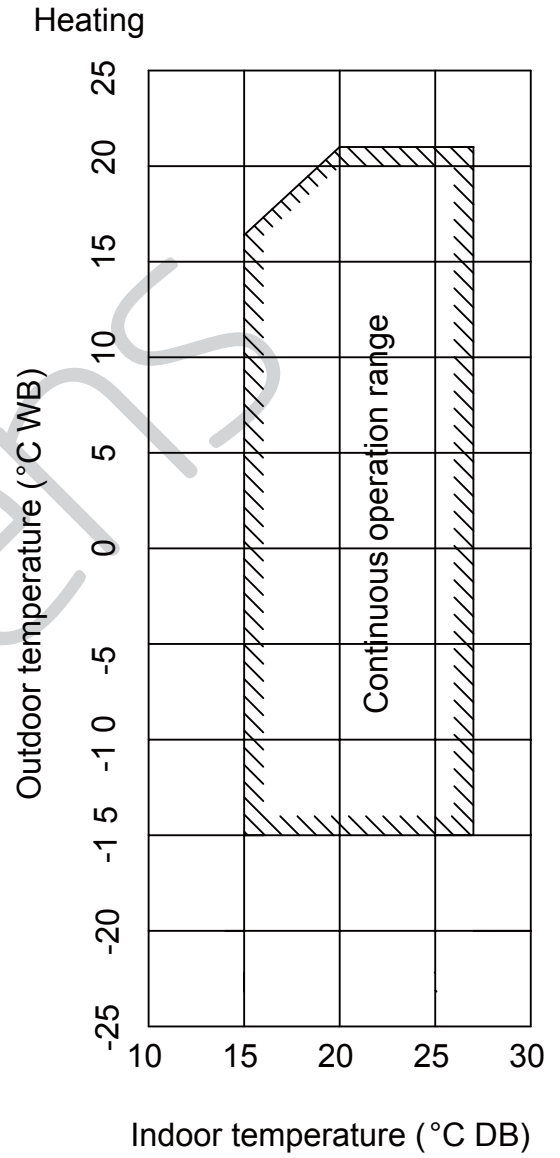
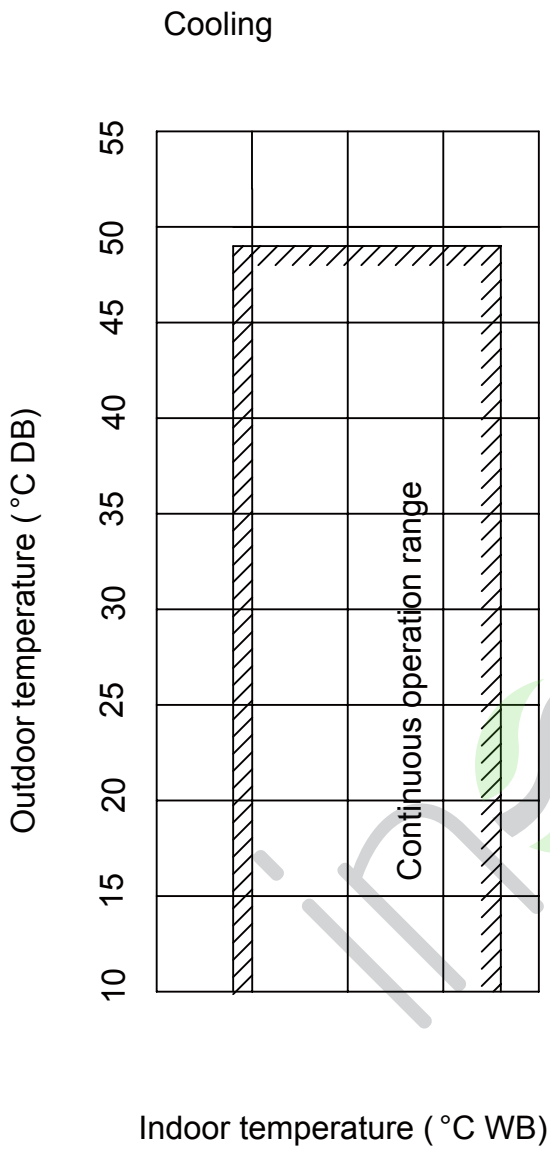

11. Noise Level

(1) Testing illustration

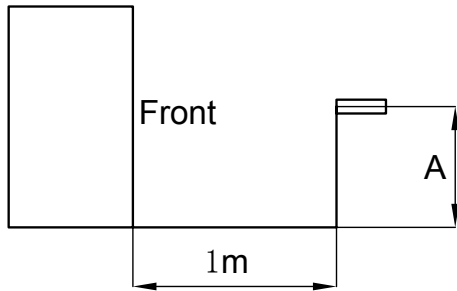

(2) Testing condition:

- a. Unit running in the nominal condition
- b. Test in the semi-anechoic chamber
- c. Noise level varies from the actual factors such as room structure, etc.

(3) Octave band level

AV08NFKERA

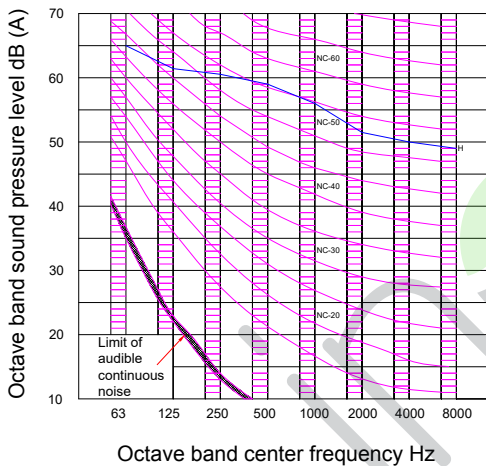

AV10NFKERA

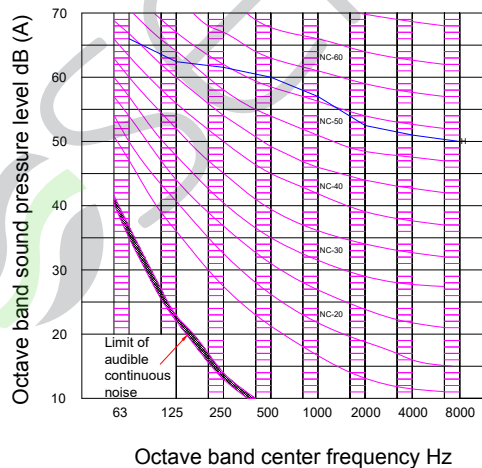

AV12NFKERA

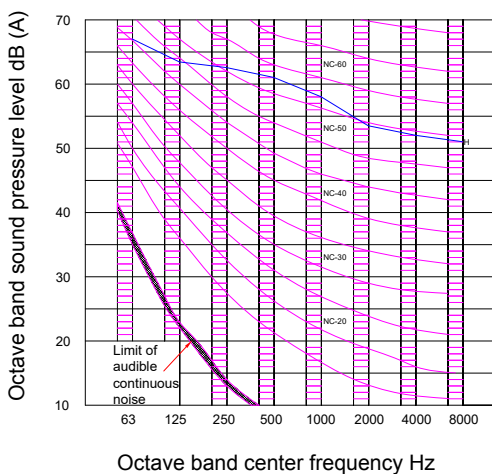

12. Outdoor Installation

12.1 Safety

The outdoor unit adopts "simultaneous control" type, all indoors should be heating or cooling simultaneously.

To protect compressor, before startup, the unit should be electrified for over 12 hours. If the unit is not used for a long time, please cut off the power to save energy, or the unit will consume the power.

⚠WARNING

- If the supply cord is damaged, it must be replaced by the manufacturer, its service agent or similarly qualified persons in order to avoid a hazard.
- This appliance is not intended for use by persons (including children) with reduced physical, sensory or mental capabilities, or lack of experience and knowledge, unless they have been given supervision or instruction concerning use of the appliance by a person responsible for their safety.
- Children should be supervised to ensure that they do not play with the appliance.
- This appliance can be used by children aged from 8 years and above and persons with reduced physical, sensory or mental capabilities or lack of experience and knowledge if they have been given supervision or instruction concerning use of the appliance in a safe way and understand the hazards involved. Children shall not play with the appliance. Cleaning and user maintenance shall not be made by children without supervision.
- The appliances are not intended to be operated by means of an external timer or separate remote-control system.
- Keep the appliance and its cord out of reach of children less than 8 years.
- If the air conditioner is transferred to the others, this manual should be transferred together.
- Before installation, please read "Safety precaution" carefully to confirm the correct installation.
- The mentioned precaution includes "⚠WARNING" and "⚠CAUTION". The precaution caused death or heavy injury for faulty installation will be listed in "⚠WARNING". Even the cautions listed in "⚠CAUTION" also may cause serious accident. So both of them are related to the safety, and should be executed severely.
- After installation, perform a trial and confirm everything normal, then introduce the operation manual to the user. Besides, put the manual to the user and ask them to preserve it carefully.

⚠WARNING

- The installation or the maintenance should be performed by the authorized agency. Or the non-specialized operation will cause water leakage, electric shock or fire etc accidents.
- The installation should be executed as per the manual, or the faulty installation will cause water leakage, electric shock or fire etc accidents.
- Please install the unit at the space which can bear the weight. Or the unit will drop down to cause the human injury.
- The installation should defend against the typhoon, and the earthquake etc. Abnormal installation will cause the unit fall down.
- Use the correct cable and make reliable earthing. Fix the terminal firmly and the loose connection will cause heating or fire etc accident.
- The wiring should be in shape and can not be raised. Be earthed firmly and can not be clipped by the electric box cover or the other plate. The incorrect installation will cause heating or fire.
- When setting or transferring the unit, there should not be other air into the refrigerant system except for R410A. The gas mixture will cause the abnormal high pressure which will cause break or human injury etc accidents.
- When installation, please use the accessories with the unit or the special parts, or it will cause water leakage, electric shock, fire, refrigerant leakage etc accidents.
- Don't lead the water drainage pipe into the drainage groove with the poisonous gas, such as sulphur. Or the poisonous gas will enter indoor.
- In installation or after installation, please confirm if there is refrigerant leakage, please take measures for ventilation. The refrigerant will cause poisonous gas as meeting fire.
- Don't install the unit at the place where there may be flammable gas leakage. In case the gas leaks and gather around the unit, it will cause fire.
- The drainage pipe should be installed as per the manual to confirm the fluent drainage. Also take measures for heat insulation against dew drop. Incorrect water pipe installation will cause water leakage even and make the things wet.

- For the liquid pipe and the gas pipe, take measures for heat insulation too. If there is no heat insulation, the dew drop will wet the things.
- If the supply cord is damaged, it must be replaced by the manufacturer, its service agent or similarly qualified persons in order to avoid a hazard.
- This appliance is not intended for use by persons (including children) with reduced physical, sensory or mental capabilities, or lack of experience and knowledge, unless they have been given supervision or instruction concerning use of the appliance by a person responsible for their safety.
- Children should be supervised to ensure that they do not play with the appliance.
- This appliance can be used by children aged from 8 years and above and persons with reduced physical, sensory or mental capabilities or lack of experience and knowledge if they have been given supervision or instruction concerning use of the appliance in a safe way and understand the hazards involved. Children shall not play with the appliance. Cleaning and user maintenance shall not be made by children without supervision.
- The appliances are not intended to be operated by means of an external timer or separate remote-control system.
- Keep the appliance and its cord out of reach of children less than 8 years.

⚠CAUTION

- Execute earthing for the unit. But the earthing wire can not be connected to the gas pipe, water pipe, lightning rod or the telephone earthing wire. Improper earthing will cause electric shock.
- Don't install the unit at the place where leaks the flammable gas. Or it will cause fire.
- Execute the water drainage pipe according to the manual, improper installation will cause water leakage to wet the family things.
- The outdoor fan can not face to the flower or the other vegetable, or the blowing gas will make the flower dried up.
- Please ensure the maintenance room, if not, it will cause the maintenance person damaged.
- When installing the unit on the roof or the other high place, to prevent the person falling down, please set the fixed ladder and the railing at the passage.
- Use the two-end spanner, and fasten the nut at proper torque. Don't fasten the nut excessively against the flared section broken. Or it will cause refrigerant leakage and lack of oxygen.
- Take measures for heat insulation to the refrigerant pipe, or there will be water leakage or dew drop to wet the family things.
- After finishing the refrigerant pipe, make leakage test by charging the nitrogen. In case the refrigerant leaks in a small room and exceeds the limited concentration, it will cause lack of oxygen.
- Don't use the other refrigerant except for R410A. The R410A pressure is 1.6 times higher than R22 pressure. The refrigerant R410A tank is marked with pink sign.
- Against charging different refrigerant, we changed the stop valve diameter of the R410A unit. To enhance the compression consistence, we also changed the flared pipe dimension. Prepare the R410A specially tools according to the below table.

	R-410A specified tools	Remarks
1	Gauge manifold	Range: HP > 4.5MPa, LP > 2MPa
2	Charge hose	Pressure: HP: 5.3MPa, LP: 3.5MPa
3	Electronic balance for charging R410A	Can not use the measurable charging tank
4	Torque spanner	
5	Flare tool	
6	Copper pipe gauge for adjusting projecting margin	
7	Vacuum pump adapter	Must be with reverse stop valve
8	Leakage detector	Can not use freon leakage detector, but the He detector

- When charging refrigerant, the refrigerant must be taken out as liquid state from the tank.

12.2 Installation instruction

In installation, please check specially the below items:

- If the connected units quantity and the total capacity is in the allowable range?
- If the refrigerant pipe length is in the limited range?
- If the pipe size is proper? And if the pipe is installed horizontally?
- If the branch pipe is installed horizontally or vertically?
- If the additional refrigerant is counted correctly and weighed by the standard balance?
- If there is refrigerant leakage?
- If all the indoor power supplies can be on/off simultaneously?
- If the power voltage is in compliance with the data marked on the rating label?
- If the address of indoors has been set?

(1) Before installation

- 1) Before installation, check if the model, power supply, pipe, wires and parts purchased respectively are correct.
- 2) Check if the indoors and outdoors can be combined as the following.

Outdoor	Indoor	
Model	Indoor Qty	Total indoor capacity(X 100W)
AU08NFKERA	13	113~293
AU10NFKERA	16	140~364
AU12NFKERA	19	158~410

(2) Installation place selection

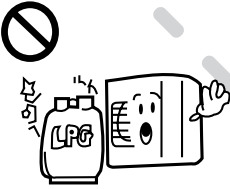
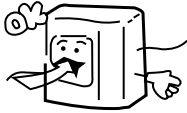
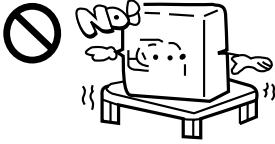
<p>Air-conditioner can't be installed in the place with inflammable gas. Or it will cause fire hazard.</p> 	<p>The unit should be installed at the place with good ventilation. No obstacle at the air inlet/outlet. And no strong wind blows the unit.</p>  <p>The installation space refers to the latter info.</p>	<p>The unit should be installed at the strong enough place. Or it will cause vibration and noise.</p> 
------------------------------------------------------------------------------------------------------------------------------------------------------------------------------------------------	----------------------------------------------------------------------------------------------------------------------------------------------------------------------------------------------------------------------------------------------------------------------------------------------	---------------------------------------------------------------------------------------------------------------------------------------------------------------------------------------------

The unit should be installed at the place where the cold/hot air or noise will not interfere the neighbours.



- The place where the water can flow fluently.
- The place where no other heat source will affect the unit.
- Pay attention to the snow against clogging the outdoor.
- In installation, install the anti-vibration rubber between the unit and the bracket.

- The unit is better not be installed at the below places, or it will cause damage.
- The place where there is corrosive gas (spa area etc).
- The place blowing salty air (seaside etc).
- Exists the strong coal smoke.
- The place with high humidity.
- The place where there is device emitting Hertzian waves.
- The place where voltage changes greatly.

(3) Transportation

- Please remove the outdoor unit to the installation location as far as possible near place before open the packaging.
- Forbid on the equipments to place anything, need to use 2 ropes while promoting outdoor.
- Please according to following way hoisting outdoor:
 Ensure that the outdoor unit when hosting the level to rise slowly.
 Do not remove the packaging.
 When hoisting do not have to tie up the elevator to the unit hits on the packaging and the outside wrapping.
 When hoisting exterior must use the suitable protection.

Handling

Before the installation, outdoor do not deposit any material, otherwise likely has the fire or the accident.

When handling unit, please operate as shown in the following figure and note the following points

1. Forbids to demolish the wooden foundation.
2. Prevent the outdoor to incline.
3. Should be handling more than two.

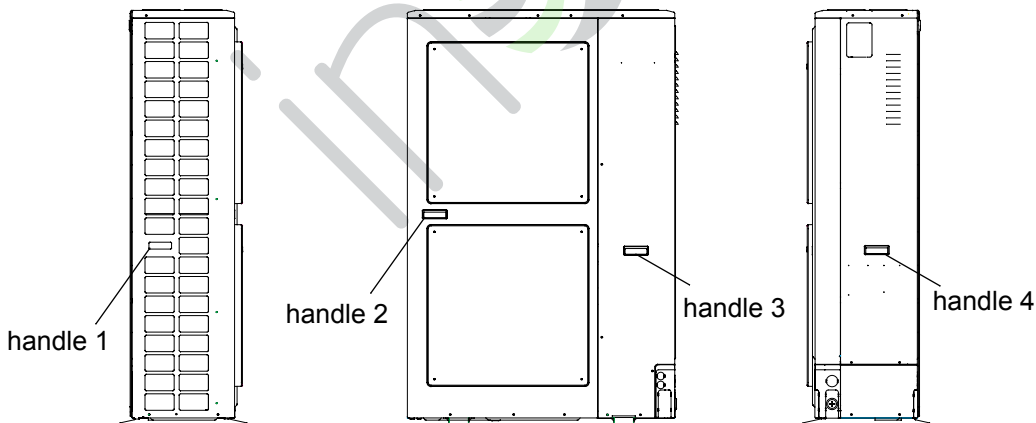

Outdoor Installation

Installation location

- Outdoor unit should be placed in well ventilated and dry place.
- Outdoor noise and exhaust should not affect neighbors and around the ventilation.
- Ensure the ground steadily reliable.
- Do not install the outdoor unit on high oil,salt spray or harmful gases.
- Don't being installed to electromagnetic wave can directly radiate an electricity box and keep off electromagnetic wave radiation possibly, at least more than 3 meters.
- When ice snow overlay area installs outdoor unit, please add to defend snow cover.
- Outdoor unit installed in the shade,avoiding direct sunlight or high temperature heat sources of radiation.
- Do not install in dusty or polluted place to prevent outdoor unit heat exchanger jam.
- The outdoor unit should install in the public unapproachable place.

Installation and maintenance space

As shown below, install the outdoor unit should allow sufficient space for handing and maintenance.

Case 1: stumbling block on the inlet ,also upside opens.

Single installation around the opening

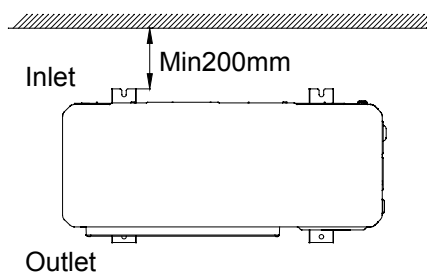

Single installation around the closed

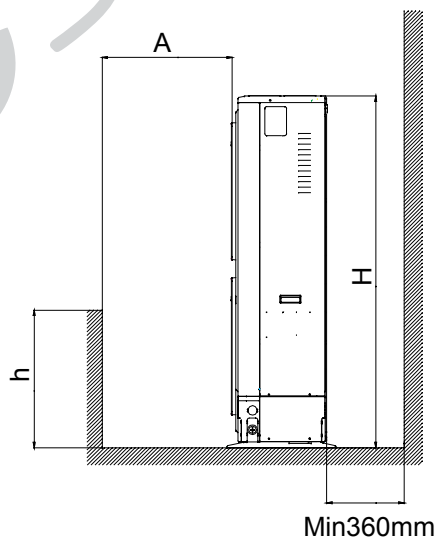
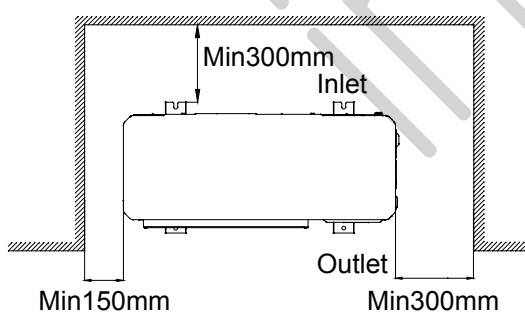

Multi Outdoor

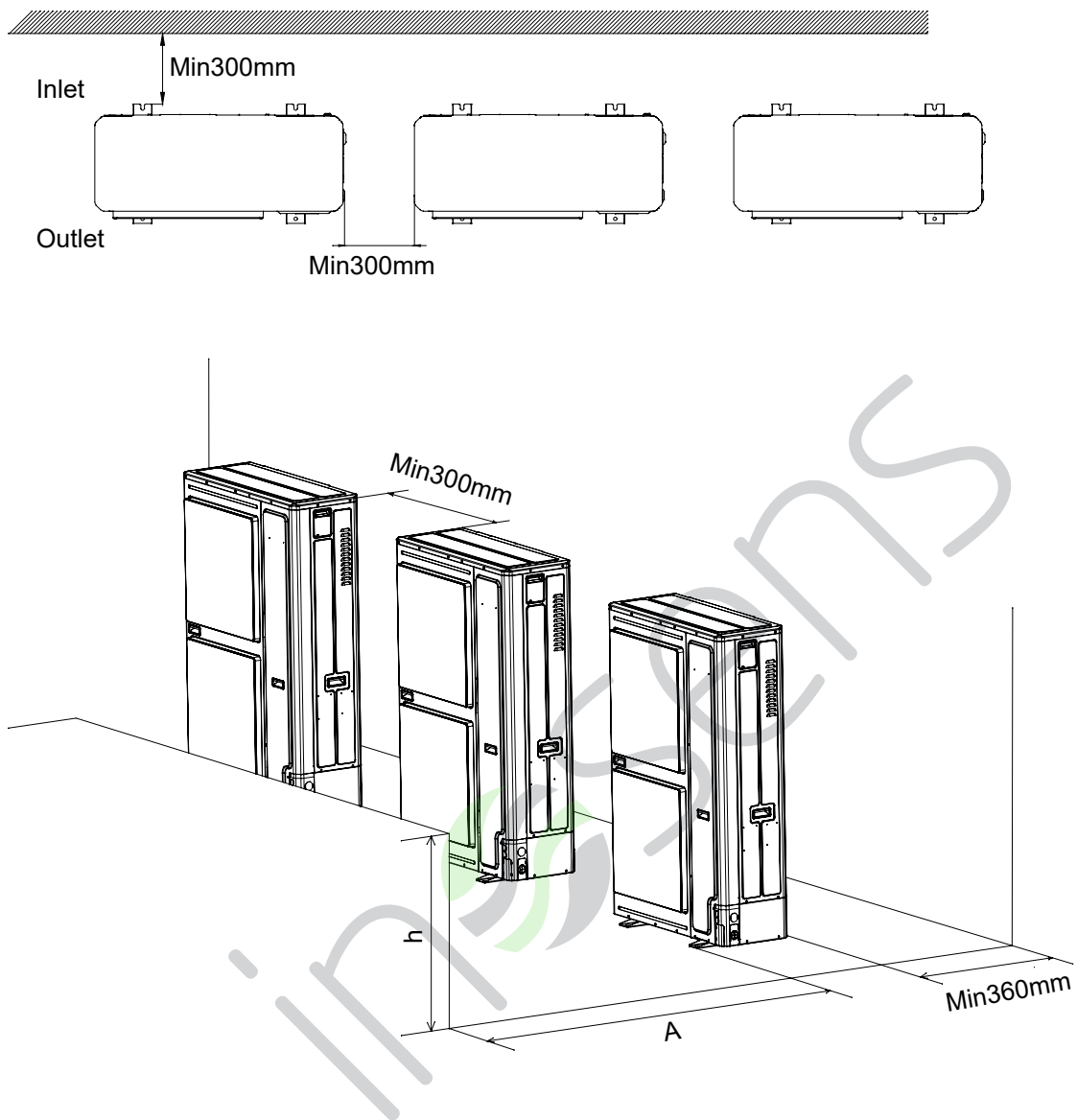

Case 2: obstacles on the inlet and top side

Single Outdoor

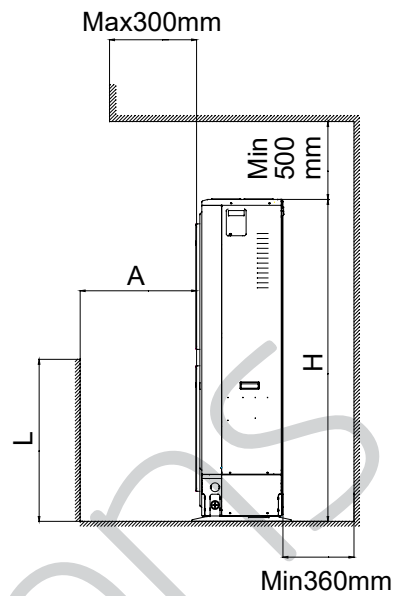
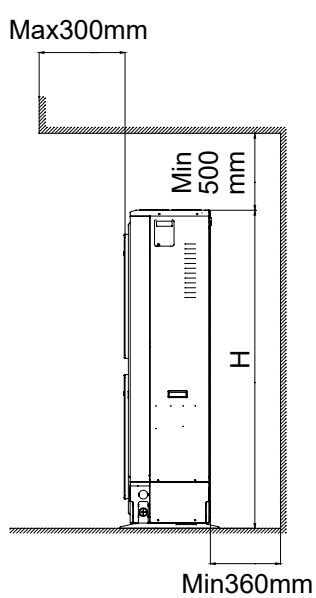

Multi Outdoor

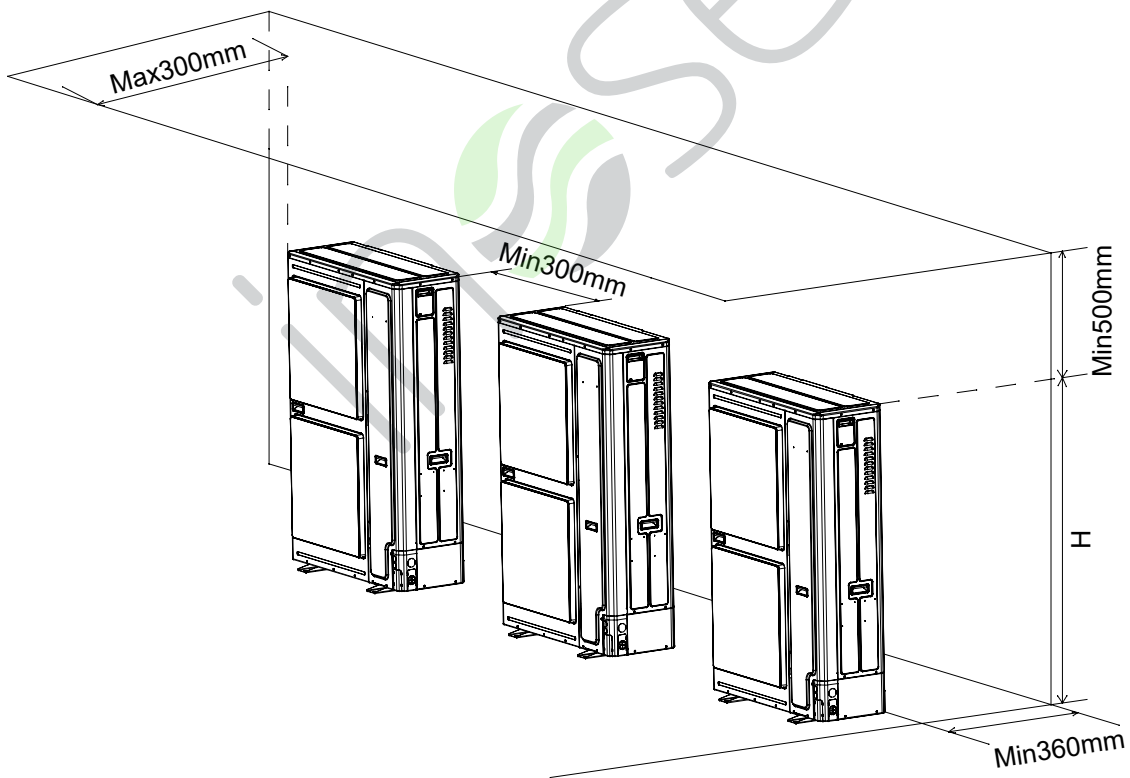

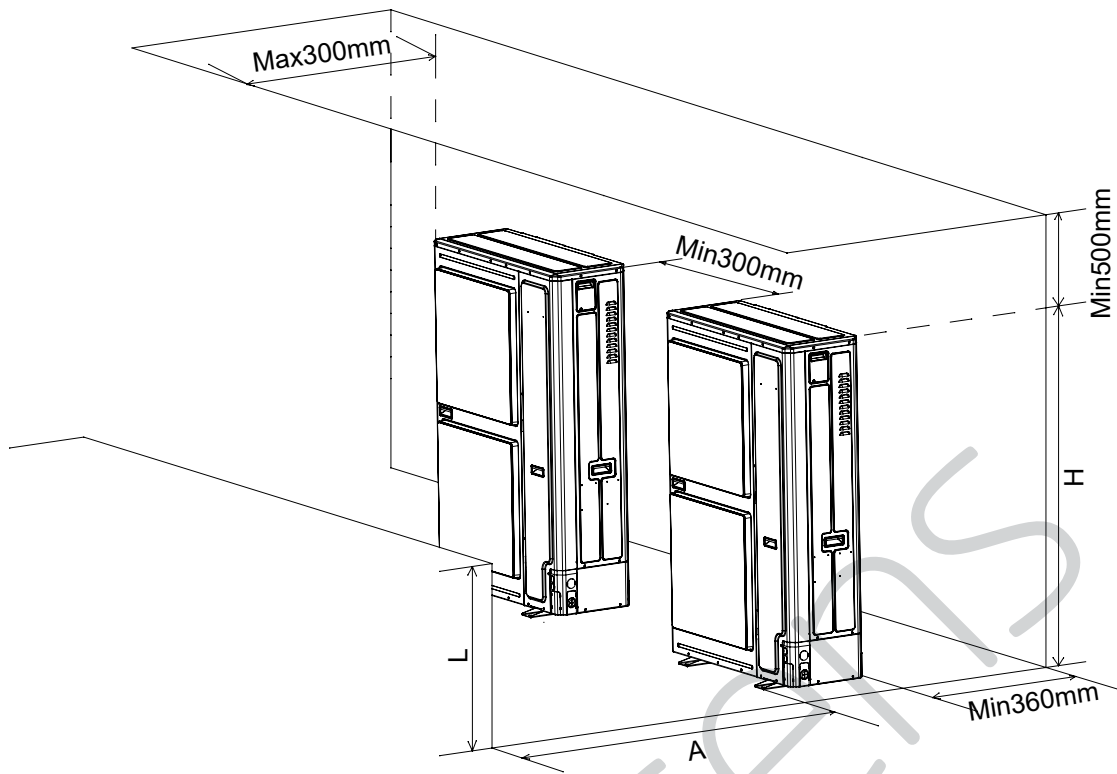

Case 3: obstacles on the outlet, both right and left side

Single Outdoor

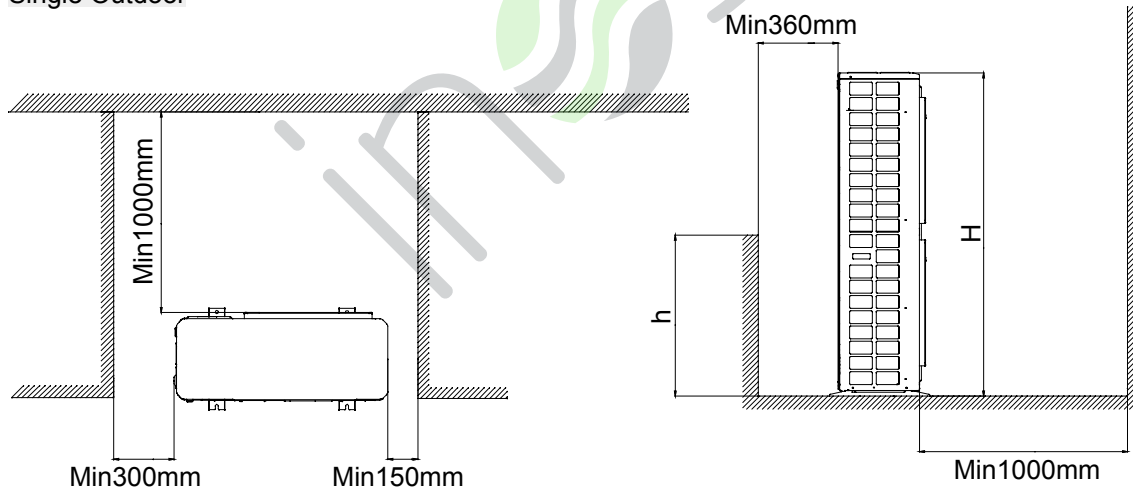

Multi Outdoor

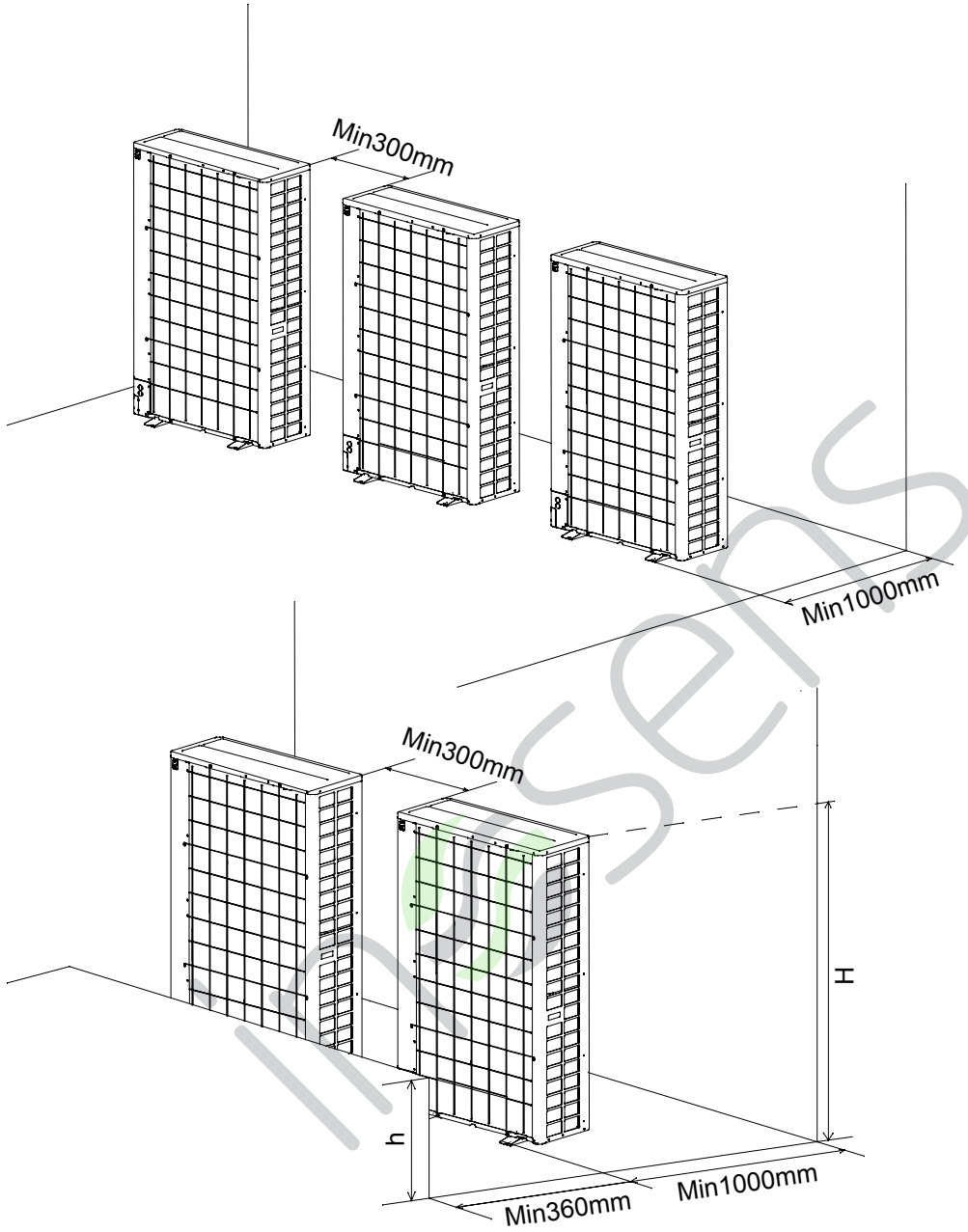

If $h > H$, please set the outdoor on the foundation to make sure $H \geq h$.
 H = The height of outdoor and foundation

h	A
$0 < h \leq 1/2H$	Over 600
$1/2H < h \leq H$	Over 1400

Note: Avoid making air short cycle in any case.

Multi Row Outdoor

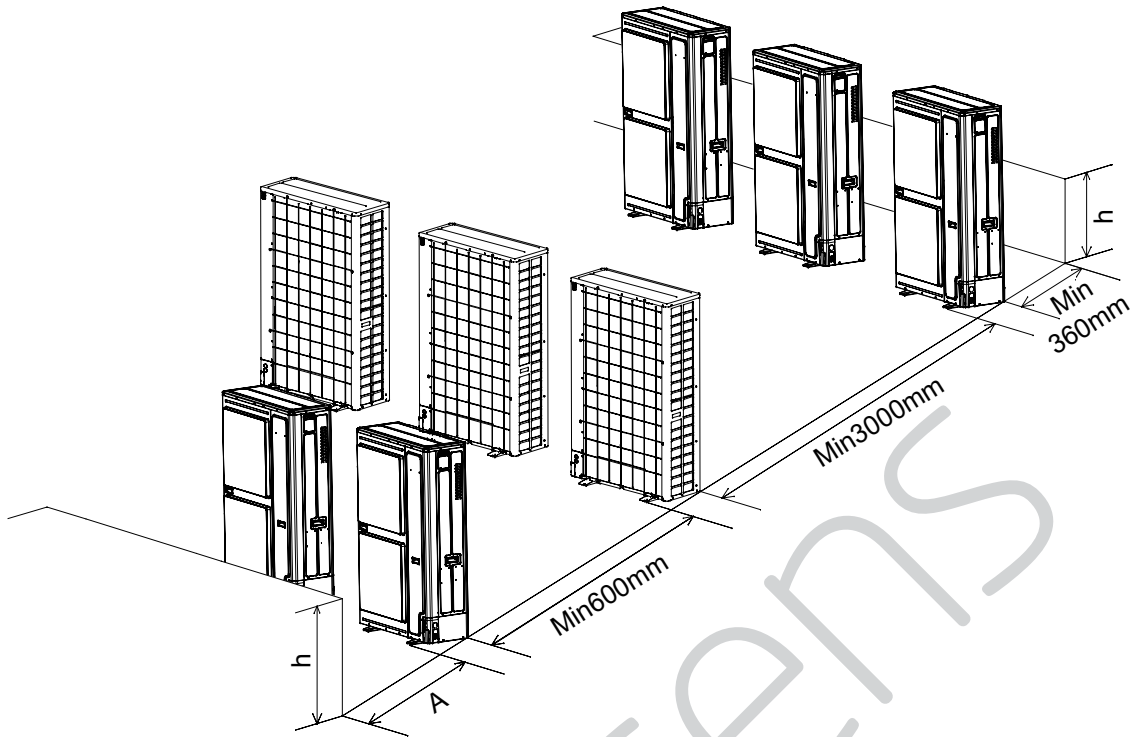

Note:

Make sure the distance at least 300mm between two neighbor units and no stumbling block.

h	A
$0 < h \leq 1/2H$	Over 600
$1/2H < h \leq H$	Over 1400

A. Refrigerant pipe connection

Pipe connection method:

- To ensure the efficiency, the pipe should be as short as possible.
- Daub the refrigerant oil on the connector and the flare nut.
- When bending the pipe, the bending semi-diameter should be as large as possible against the pipe being broken or bent.
- When connecting the pipe, aim at the center to thread the nut by hand and tighten it with the double spanners.
- Fastening torque please refers to "pipe specs and fastening torque" on page 15.
- Don't let the impurity such as sand, water etc into the pipe. Antifouling measures refer to page 13.

When fastening and loosening the nut, operate with double spanners, because only one spanner cannot execute firmly.

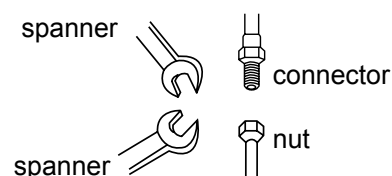

If threading the nut as not aiming at the center, the screw thread will be damaged, further it will cause leakage.

Cautions in piping installation:

1. When welding the pipe with hard solder, charge nitrogen into the pipe against oxidation. The pressure gauge should be set at 0.02MPa. Perform the procedure with nitrogen circulation. Otherwise, the oxide film in the pipe may clog the capillary and expansion valve resulting in accident.
2. The refrigerant pipe should be clean. If the water and the other impurity enter the pipe, charge the nitrogen to clean the pipe. The nitrogen should flow under the pressure of about 0.5Mpa and when charging the nitrogen, stop up the end of the pipe by hand to enhance the pressure in the pipe, then loose the hand (meanwhile stop up the other end).
3. The piping installation should be executed after the stop valves are closed.
4. When welding the valve and the pipe, cool down the valve with wet towel.
5. When the connection pipe and the branch pipe need to be cut down, please use the special shears and cannot use the saw.
6. When welding copper pipe, use the phosphor copper welding rod without any welding flux. (welding flux will damage the piping system. The welding flux containing chlorine will corrode pipe, especially, the welding flux with fluorin will damage refrigeration oil.)

Pipe material and specs selection

1. Please select the refrigerant pipe of the below material.
Material: the phosphoric oxidize seamless copper pipe, model: C1220T-1/2H (diameter is over 19.05); C1220T-0(diameter is below 15.88).
2. Thickness and specs:
Confirm the pipe thickness and specs according to the pipe selection method(the unit is with R410A, if the pipe over 19.05 is 0-type, the pressure preservation will be bad, thus it must be 1/2H type and over the min. thickness.
3. The branch pipe and the gather pipe must be from Haier.
4. When installing the stop valve, refer to the relative operation instruction.
5. The pipe installation should be in the allowable range.
6. The installation of branch pipe and gather pipe should be performed according to the relative manual.

Anti-fouling measures

First, clean the pipe.

Position	Installation period	Measures
Outdoor	More than 1 month	Flat the pipe end
	Less than 1 month	Flat the pipe end or seal with adhesive tape
Indoor	Nothing to do with period	

Pipe specification:

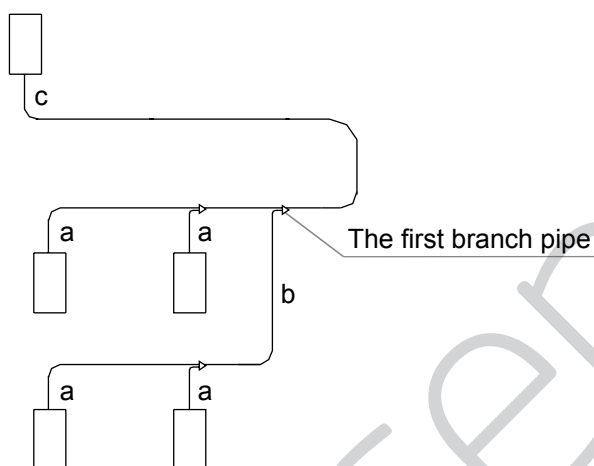

1. Pipe "a" diameter (between indoor and branch pipe) depends on indoor pipe, the diameter of the gas and liquid pipe of the indoor units shall be according to the installation manual for indoor units.

2. Pipe "b" diameter (between branch pipes)

Total indoor capacity after the branch pipe (kW)	Gas pipe (mm)	Liquid pipe (mm)
<16.8kW	Ø15.88	Ø9.52
16.8kW≤X<22.4kW	Ø19.05	Ø9.52
22.4kW≤X<33.0kW	Ø22.22	Ø9.52
33.0kW≤X<47.0kW	Ø28.58	Ø12.7

Note:

Adjust the diameter on field (changing pipe is needed)

When the latter indoor total capacity is less than 14.0kw, pipe b will use the specs as the pipe a.

3. Pipe "c" diameter (main pipe, between outdoor gather pipe and the first branch pipe)

Model	Main pipe		Enlarged main pipe	
	Gas pipe (mm)	Liquid pipe (mm)	Gas pipe (mm)	Liquid pipe (mm)
AU08NFKERA	Ø19.05	Ø9.52	Ø22.22	Ø12.7
AU10NFKERA	Ø22.22	Ø9.52	Ø25.4	Ø12.7
AU12NFKERA	Ø25.4	Ø12.7	Ø28.58	Ø15.88

Note:

When the distance from outdoor unit to the longest indoor unit is over 90m, the diameter of main pipe should be enlarged.

Copper pipe selection:

Material	O type pipe: Soft pipe			
Pipe diameter (mm)	Ø6.35	Ø9.52	Ø12.7	Ø15.88
Thickness(mm)	0.8	0.8	1.0	1.0

Material	Hard pipe				
Pipe diameter (mm)	Ø19.05	Ø22.22	Ø25.4	Ø28.58	Ø31.8
Thickness(mm)	1.0	1.0	1.0	1.0	1.1

Long pipe and high drop

1. Applicable range

Item	Model	Outdoor
Single way total pipe length		300m
Single way pipe length		Max.: 150m (Equal Length 175m)
Main pipe between outdoor to 1st branch		Max.: 110m (Equal Length 135m)
Pipe length between outdoors		Less than 10m to 1st branch pipe
Height difference between indoor and outdoor	Outdoor is upper	Max. 50m
	Outdoor is lower	Max. 40m
Height difference between outdoors (in the same system)		Within 5m (better be horizontal)
Height difference between indoors		Max. 15m

Unit pipe spec and connection method (unit: mm)

A. Outdoor unit

Model	Gas pipe side		Liquid pipe side	
	Diameter (mm)	Connecting method	Diameter (mm)	Connecting method
AU08NFKERA	Ø19.05	Flared joint	Ø9.52	Flared joint and Brazing
AU10NFKERA	Ø22.22	Flared joint and Brazing	Ø9.52	
AU12NFKERA	Ø25.4			Ø12.7

B. Indoor unit

Model Capacity	Gas pipe side		Liquid pipe side	
	Diameter (mm)	Connecting method	Diameter (mm)	Connecting method
07	Ø9.52	Braze	Ø6.35	Flared
09	Ø9.52		Ø6.35	
12	Ø12.7		Ø6.35	
16	Ø12.7		Ø6.35	
18	Ø12.7		Ø6.35	
24	Ø15.88		Ø9.52	
28	Ø15.88		Ø9.52	
30	Ø15.88		Ø9.52	
38	Ø15.88		Ø9.52	
48	Ø15.88		Ø9.52	
72	Ø25.4		Ø9.52	
96	Ø25.4		Ø9.52	

C. Pipe spec and the torque

Diameter (mm)	Torque(N·m)
Ø6.35	14~18
Ø9.52	34~42
Ø12.7	49~61
Ø15.88	68~82
Ø19.05	84~98

Branch pipe

Branch pipe selection:

Total indoor capacity(100W)	model(optional)
Less than 335	FQG-B335A
More than 335, less than 506	FQG-B506A

Outdoor unit type

The master unit will choose the closest one to the 1st branch pipe.

Note:

- When connecting the outdoor branch pipe and the outdoor, please pay attention to the outdoor pipe dimension.
- When adjusting the diameter among outdoor branch pipe and among the units, please must execute at the branch pipe side.
- Please install the outdoor branch pipe (gas/liquid side) in horizontal or vertical direction.
- When welding with hard solder, please must blow nitrogen. If not, a number of oxide will be produced and cause heavy damage. Besides, to prevent water and dust into the pipe, please make the brim as outer roll.

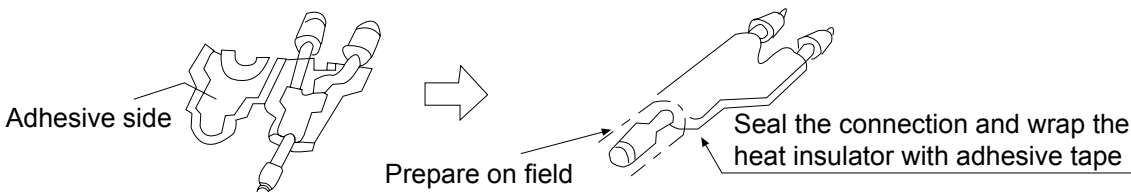

Cut off pipe with the cutter

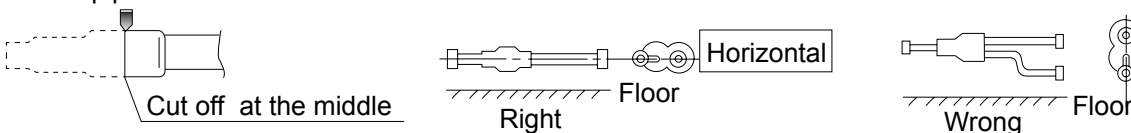

Pipe installation

When doing the piping connection, please do the following:

- Please don't let the pipe and the parts in the unit collide each other.
- When connecting the pipes, close the valves fully.
- Protect the pipe end against the water, impurity into the pipes (welding after being flat, or being sealed with adhesive tape).
- Bend the pipe as large semi-diameter as possible(over 4 times of the pipe diameter).
- The connection between outdoor liquid pipe and the distributing pipe is flared type. Please expand the pipe with the special tool for R410A after installing the expanding nut. But if the projecting pipe length has been adjusted with the copper pipe gauge, you can use the original tool to expand the pipe.
- Since the unit is with R410A, the expanding oil is ester oil, not the mineral oil.
- When doing the flare connection, please do the following: When connecting the expanding pipe, fasten the pipes with double-spanner. The torque refers to the former info.

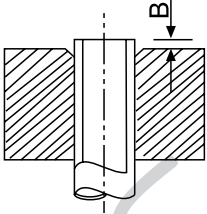
Expanding pipe:A(mm)			Projecting length of pipe to be expanded:B(mm)								
Pipe outer diameter (mm)	A		Pipe outer diameter (mm)	When it is hard pipe							
Ø6.35	0 -0.4	<table border="1"> <thead> <tr> <th>Pipe outer diameter (mm)</th> <th>Special tool for R410A</th> <th>The former tool</th> </tr> </thead> <tbody> <tr> <td>Ø6.35</td> <td rowspan="4">0-0.5</td> <td rowspan="4">1.0-1.5</td> </tr> <tr> <td>Ø9.52</td> </tr> <tr> <td>Ø12.7</td> </tr> <tr> <td>Ø15.88</td> </tr> </tbody> </table>	Pipe outer diameter (mm)	Special tool for R410A	The former tool	Ø6.35	0-0.5	1.0-1.5	Ø9.52	Ø12.7	Ø15.88
Pipe outer diameter (mm)	Special tool for R410A		The former tool								
Ø6.35	0-0.5		1.0-1.5								
Ø9.52											
Ø12.7											
Ø15.88											
Ø9.52	9.1										
Ø12.7	13.2										
Ø15.88	16.6										

- The outdoor gas pipe and the refrigerant distributing pipe, as well the refrigerant distributing pipe and the branch pipe should be welded with hard solder.
- When doing the braze connection, please do the following: Brazing the pipe at the same time charge the nitrogen. Or it will cause a number of impurity (a film of oxidation) to clog the capillary and the expansion valve, further cause the deadly failure.

Operation procedure

- Brazing the pipe at the same time charge the nitrogen. Or it will cause a number of impurity (a film of oxidation) to clog the capillary and the expansion valve, further cause the deadly failure.

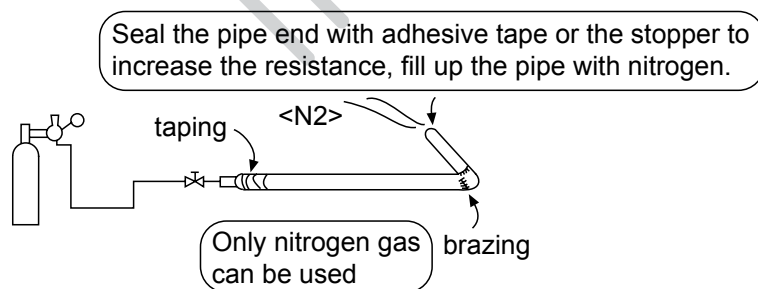

- Protect the pipe end against the water, impurity into the pipes (welding after being flat, or being sealed with adhesive tape).

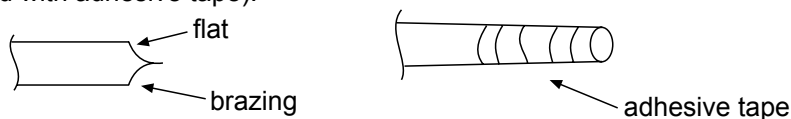

- The refrigerant pipe should be clean. The nitrogen should flow under the pressure of about 0.5MPa and when charging the nitrogen, stop up the end of the pipe by hand to enhance the pressure in the pipe, then loose the hand (meanwhile stop up the other end).

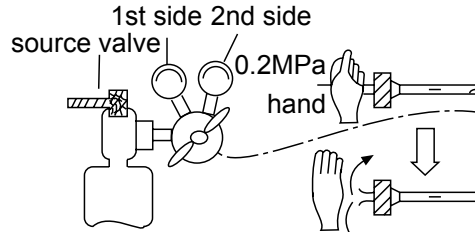

- When connecting the pipes, close the valves fully.
- When welding the valve and the pipes, use the wet cloth to cool down the valve and the pipes.

B. Leakage test

1. The outdoor unit has been executed the leakage test in the factory. The pipe should be executed leakage test individually and forbidden to test after connecting with stop valve.
2. Refer to the below figure to charge the nitrogen into the unit to take a test. Never use the chlorin, oxygen, flammable gas in the leakage test. Apply pressure both on the gas pipe and the liquid pipe.
3. Apply the pressure step by step to the target pressure.
 - a. Apply the pressure to 0.5MPa for more than 5 minutes, confirm if pressure goes down.
 - b. Apply the pressure to 1.5MPa for more than 5 minutes, confirm if pressure goes down.
 - c. Apply the pressure to the target pressure (4.15MPa), record the temp. and the pressure.
 - d. Leave it at 4.15MPa for over 1 day, if pressure does not go down, the test is passed. Meanwhile, when the temp. changes for 1degree, pressure will change 0.01MPa as well. Correct the pressure.
 - e. After confirmation of a~d, if pressure goes down, there is leakage. Check the brazing position, flared position by laying on the soap. modify the leakage point and take another leakage test.
4. After leakage test, must execute the evacuation.

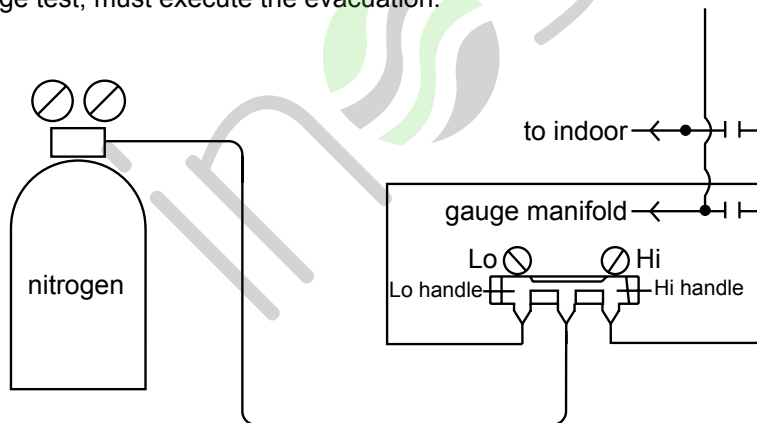

C. Evacuation

Evacuate at the check valve of liquid stop valve and both sides of the gas stop valve. The oil equalization pipe also must be vacuum (executed at the oil equalization pipe check valve respectively).

Operation procedure:

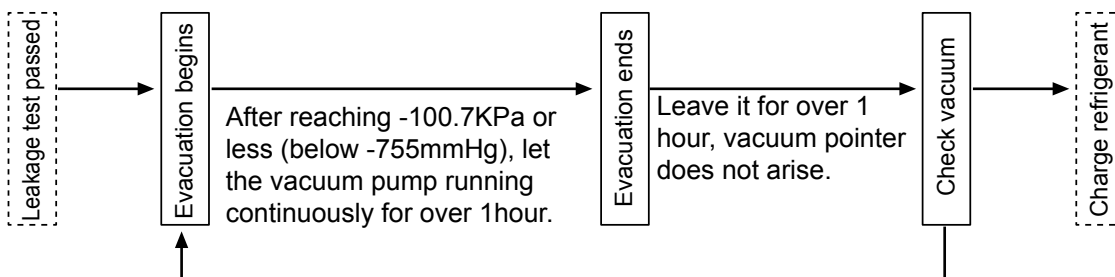

If vacuum pointer arises, it shows there is water or leakage in the system, please check and modify it, and then evacuate again.

Because the unit is with refrigerant R410A, the below issues should be paid attention:

- To prevent the different oil into the pipe, please use the special tool for R410A, especially for gauge manifold and charging hose.
- To prevent the compressor oil into the refrigerant cycle, please use the anti-counter-flow adapter.

D. Check valve operation

Open/close method:

- Take down the valve cap, gas pipe turns to "open" state as right figure.
- Turn the liquid pipe with hexangular spanner until it stops. If opening the valve strongly, the valve will be damaged.
- Tighten the valve cap.

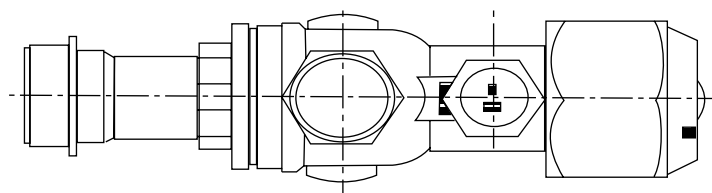
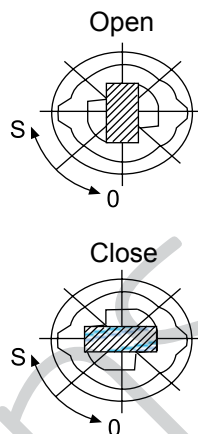

Tighten torque as the table below:

Tighten torque N·m			
	Shaft (valve body)	Cap (cover)	T-shape nut (check joint)
For gas pipe	8~9	22~27	8~10
For liquid pipe	5~6	13~16	8~10

E. Additional refrigerant and oil charging

Charge the additional refrigerant as liquid state with the gauge.

If the additional refrigerant can not be charged totally when the outdoor stops, charge it at the trial mode.

If the unit runs for a long period in the state of lack of refrigerant, compressor will occur failure. (the charging must be finished within 30 minutes especially when the unit is running, meanwhile charging the refrigerant).

The unit is charged only part of the refrigerant at the factory, also need additional refrigerant at the installation site.

W1: Refrigerant charging volume to outdoor unit at factory.

W2: Refrigerant charging volume to outdoor unit on site.

W3: Refrigerant charging volume to liquid pipe base on different piping length calculation.

W3=actual length of liquid pipe×additional amount per meter liquid pipe=

$L1 \times 0.35 + L2 \times 0.25 + L3 \times 0.17 + L4 \times 0.11 + L5 \times 0.054 + L6 \times 0.022$

Refrigerant record form							
Model	W1: Refrigerant charging volume to outdoor unit at factory	W2: Refrigerant charging volume to outdoor unit on site	W3: Refrigerant charging volume to liquid pipe base on different piping length calculation		Total refrigerant volume charging on site during installation	W: Total refrigerant volume charging on site for maintenance	
			Liquid pipe diameter (mm)	Additional refrigerant amount (kg)			
AU08NFKERA	Refer to label	0kg	Ø6.35	0.022kg/m×_m= _kg	W2+W3= _kg	W1+W2+W3= _kg	
AU10NFKERA		0kg	Ø9.52	0.054kg/m×_m= _kg			
AU12NFKERA		0kg	Ø12.7	0.11kg/m×_m= _kg			
				Ø15.88			0.17kg/m×_m= _kg
				Ø19.05			0.25kg/m×_m= _kg
				Ø22.22			0.35kg/m×_m= _kg
			W3= _kg				

Note:

- To prevent the different oil into the pipe, please use the special tool for R410A, especially for gauge manifold and charging hose.
- Mark the refrigerant type in different colour on the tank. R410A is pink.
- Must not use the charging cylinder, because the R410A will change when transferring to the cylinder.
- When charging refrigerant, the refrigerant should be taken out from the tank as liquid state.
- Mark the counted refrigerant volume due to the distributing pipe length on the label.

GWP: 2088

The product contains fluorinated greenhouse gases and its functioning relies upon such gases.

Heat insulation

- Gas pipe and liquid pipe should be heat insulated separately.
- The material for gas pipe should endure the high temperature over 120°C.
- That for liquid pipe should be over 70°C.
- The material thickness should be over 10mm, when ambient temp. is 30°C, and the relative humidity is over 80%, the material thickness should be over 20mm.
- The material should cling the pipe closely without gap, then be wrapped with adhesive tape. The connection wire can not be put together with the heat insulation material and should be far at least 20cm.

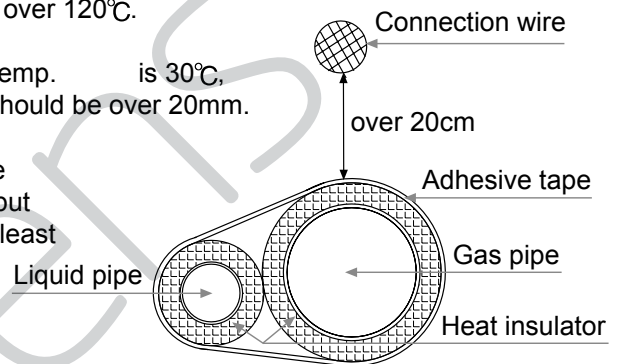

Fix the refrigerant pipe

- In operation, the pipe will vibrate and expand or shrink. If not being fixed, the refrigerant will focus on one part to cause the broken pipe.
- To prevent the central stress, fix the pipe for every 2-3m.

Communication wiring figure

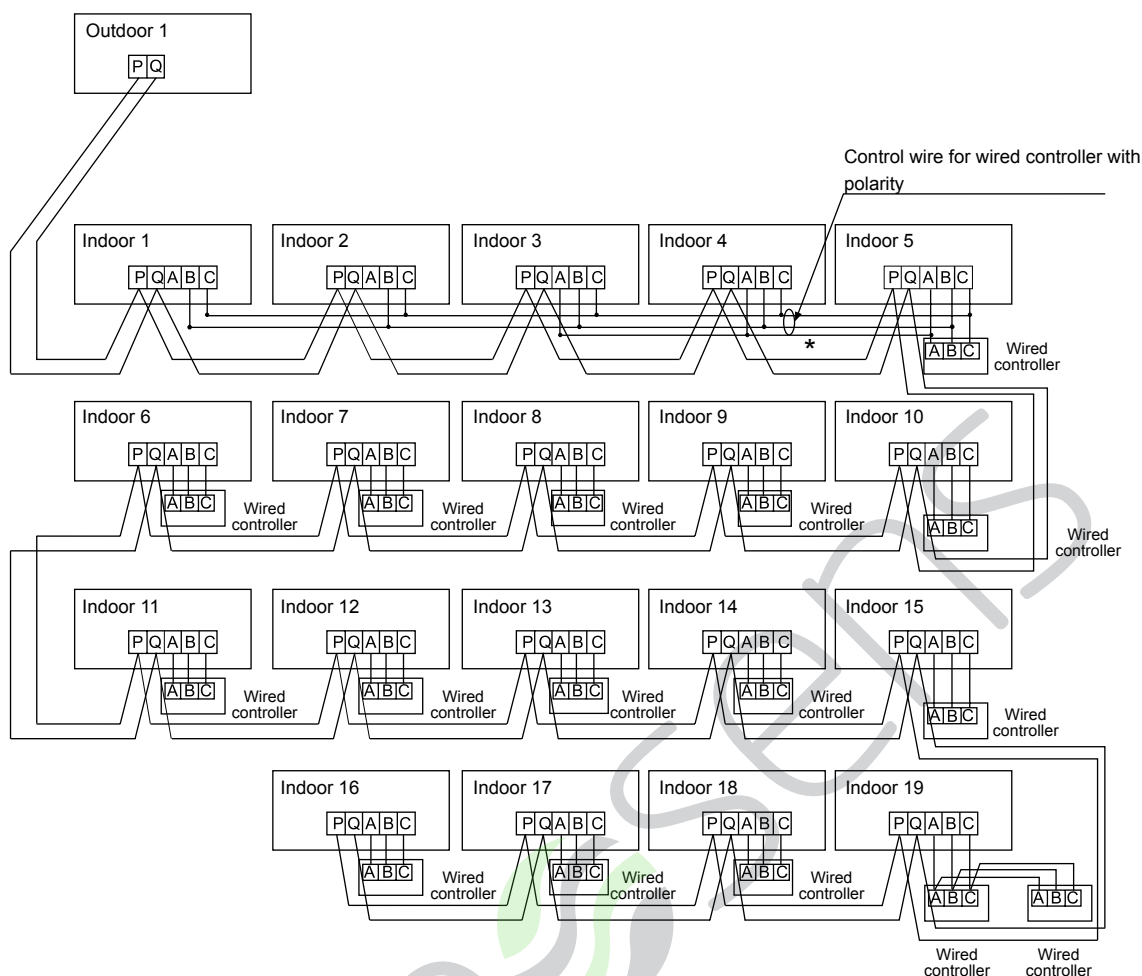

The outdoor and all indoor units are in parallel through 2 non-polar wires.

And the ground wire of the outdoor unit should pass through the buckle magnetic ring. Three wiring methods between wired controller and indoor unit:

A. 1 to multi (group control): one wired controller can control 2~19 indoors. As shown in above figure, indoor 1~indoor 5: indoor 5 is wired control master unit, the others are wired control slave units. Wired controller and the master indoor (directly connected to wired controller) is connected by 3 polar wires; the other indoors and the master indoors are connected by 2 or 3 polar wires, AC indoors wired "B" "C" polar wires, DC indoors wired "A" "B" "C" polar wires*.

B. 1 to 1 (one wired controller controls one indoor): as shown in above figure, indoor 6~ indoor 18, indoor and wired controller are connected by 3 polar wires.

C. 2 to 1 (two wired controller controls one indoor): as shown in above figure, indoor 19. Either of wired controllers can be set as master wired controller, and the other is slave wired controller. Master/slave wired controller, and master/indoor are connected by 3 polar wires.

When indoor is controlled by remote controller, refer to the "wired control master unit/wired control slave unit/remote control unit table". A, B, C on signal terminal block need not wires and not connect the wired controller.

Power wiring figure

Please make sure that when the unit is running, the input voltage is no less than 380V; if it is lower than 380V, the unit may run abnormal. And the communication line shielding layer of the outdoor unit should pass through the buckle magnetic ring.

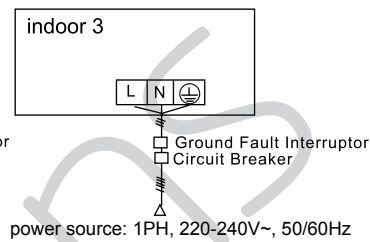
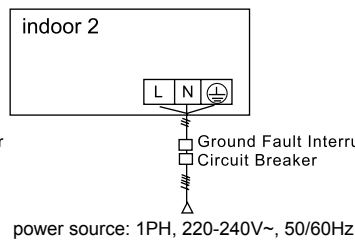
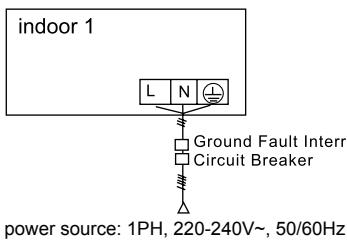
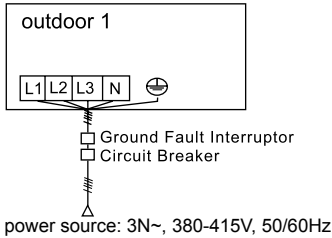

- Indoor and outdoor use their individual power source.
- All indoors use one power source.
- Must install the leakage breaker and the over current breaker, or electric shock will occur.

Outdoor power source and power cable

Item		Power source	Power cable section (mm ²)	Wire length (m)	Circuit breaker (A)	Rated current of residual circuit breaker(A) Ground fault interruptor(mA) response time(S)	Ground wire	
							Section (mm ²)	Screw
Model								
Individual power	AU08NFKERA	3N~, 380-415V, 50/60 Hz	6	20	40	40A 30mA below 0.1S	6	M5
	AU10NFKERA		10	20	40	40A 30mA below 0.1S	10	M5
	AU12NFKERA		10	20	40	40A 30mA below 0.1S	10	M5

- Power cable must be fixed firmly.
- Each outdoor must be earthed well.
- When power cable exceeds the range, thicken it appropriately.

Indoor power source and communication wiring

Item Indoor total current (A)	Power cable section (mm ²)	Wire length (m)	Rated current of overcurrent breaker (A)	Rated current of residual circuit breaker(A) Ground fault interruptor(mA) response time(S)	Communication wire section	
					Outdoor/ indoor (mm ²)	Indoor/ indoor (mm ²)
<10	2	20	20	20A, 30mA, below 0.1s	2-core × (0.75-2.0mm ²) shielded wire	
≥10 and <15	3.5	25	30	30A, 30mA, below 0.1s		
≥15 and <22	5.5	30	40	40A, 30mA, below 0.1s		
≥22 and <27	10	40	50	50A, 30mA, below 0.1s		

- Power cable and communication wire must be fixed firmly.
- Each indoor must be grounded well.
- When power cable exceeds the range, increase the gauge appropriately.
- Shielded layer of communication wires must be connected together and be earthed at single point.
- Communication wire total length cannot exceed 1000m.

Communication wire for wired controller

Length of Signal Line (m)	Wiring Dimensions
≤250	0.75mm ² × 3 core shielding line

- The shielding lay of the signal line must be grounded at one end.
- The total length of the signal line shall not be more than 250m.

Trial operation and the performance

5-minute delay function

- If starting up the unit after being powered off, the compressor will run about 5 minutes later against being damaged.

Cooling/heating operation

- Indoor units can be controlled individually, but cannot run in cool and heat mode at the same time. If the cool mode and the heat mode are existing simultaneously, the unit set latter will be standby, and the unit set earlier will run normally.
- If the A/C manager sets the unit at cooling or heating mode fixedly, the unit can not run at the other modes.

Heating mode characteristic

- In operation if outdoor temp. arises, indoor fan motor will turn to low speed or stop.

Defrosting in heating mode

- In heating mode, outdoor defrosting will affect the heating efficiency. The unit will defrost for about 2~10 minutes automatically, at this time, the condensate will flow from outdoor, also in defrosting, the vapour will appear at outdoor, which is normal. Indoor motor will run at low speed or stop, and outdoor motor will stop.

The unit operation condition

- To use the unit properly, please operate the unit under the allowed condition range. If operating beyond the range, the protection device will act.
- The relative humidity should be lower than 80%. If the unit runs at the humidity over 80% for a long period, the dew on the unit will drop down and the vapour will be blown from air outlet.

Protection device (such as high pressure switch)

- High pressure switch is the device which can stop the unit automatically when the unit runs abnormally. When the high pressure switch acts, the cooling/heating mode will stop but the running LED on wired controller will be light still. The wired controller will display failure code.
 - When the following cases occur, the protection device will act:
 - In cooling mode, air outlet and air inlet of outdoor are clogged.
 - In heating mode, indoor filter is stucked with duct; indoor air outlet is clogged.
- When protection device acts, please cut off the power source and re-start up after eliminating the trouble.

When power failure

- When power is failure in running, all the operations will stop.
- After being electrified again, if with re-start up function, the unit can resume to the state before power off automatically; if without re-start up function, the unit needs to be switched on again.
- When abnormal occurs in running because of the thunder, the lightning, the interference of car or radio, etc, please cut off the power source, after eliminating the failure, press "ON/OFF" button to start up the unit.

Heating capacity

- The heating mode adopts the heat pump type that absorbs outdoor heat energy and releases into indoor. So if outdoor temperature goes down, the heating capacity will decrease.

Trial operation

- Before trial operation:
 - Before being energized, measure the resistor between power terminal block (live wire and neutral wire) and the grounded point with a multimeter, and check if it is over 1M^{*}. If not, the unit can not operate.
 - To protect compressor, energize the outdoor unit for at least 12 hours before the unit runs. If the crankcase heater is not energized for 6 hours, the compressor will not work.
 - Confirm the compressor bottom getting hot.
 - Except for the condition that there is only one master unit connected (no slave unit), under the other conditions, open fully the outdoor operating valves (gas side, liquid side, oil equalization pipe). If operating the unit without opening the valves, compressor failure will occur.
 - Confirm all indoor units being electrified. If not, water leakage will occur.
 - Measure the system pressure with pressure gauge, at the same time, operate the unit.
- Trial operation
 - In trial operation, refer to the information of performance section.
 - When the unit can not start up at the room temperature, make trial operation for outdoor.

13. PCB Photo

PCB code: 0151800421B

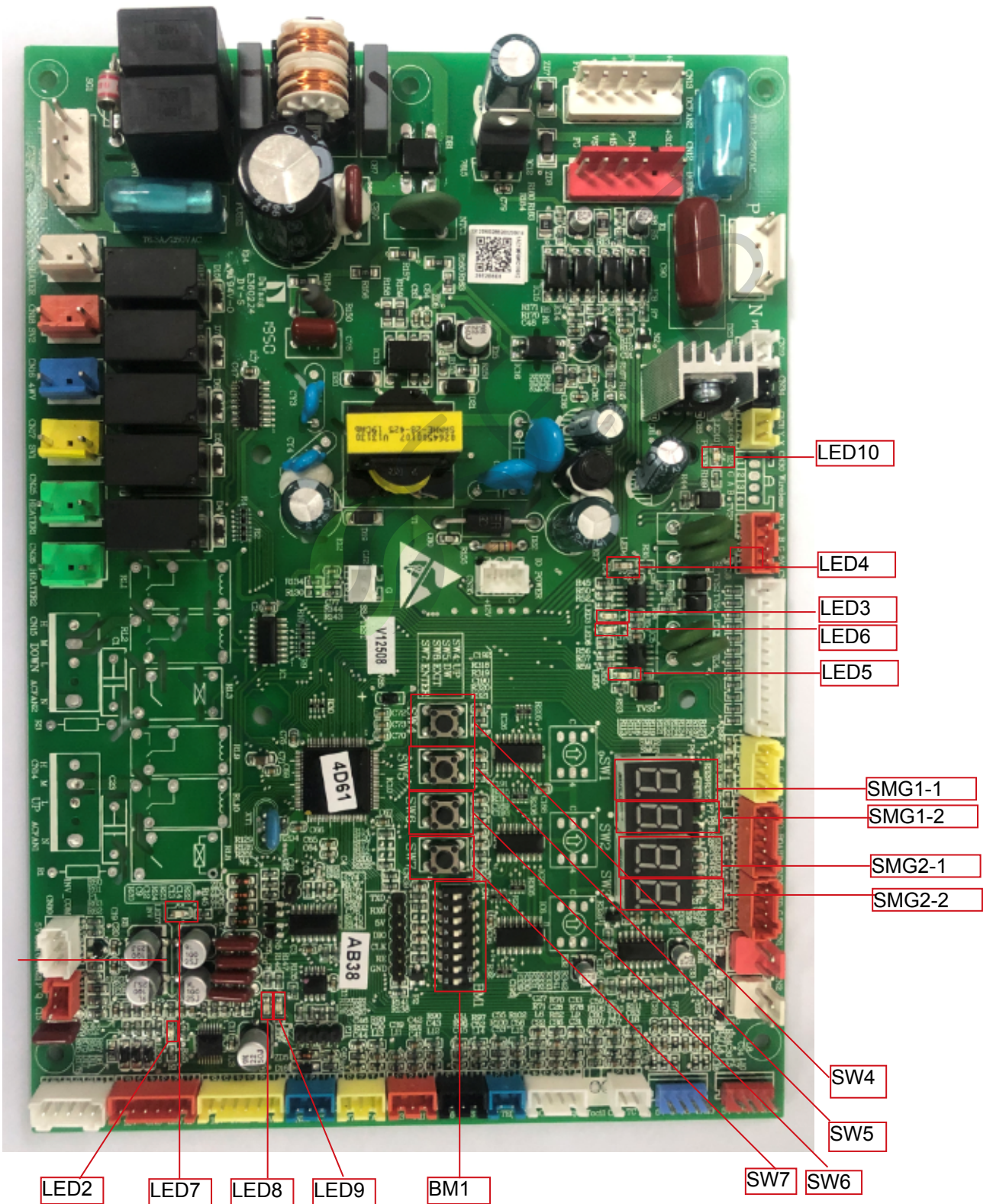

14. Dip Switch Setting

① BM1 introduction

BM1 introduction

BM1_1	Indoor unit quantity lock	0	Start to search indoor unit (Default)			
		1	Stop searching indoor unit and lock the quantity			
BM1_2	Capacity selection	BM1_2	BM1_3	BM1_4	BM1_5	Capacity selection
BM1_3		0	0	1	1	8HP
BM1_4		0	1	0	1	10HP
BM1_5		0	1	1	1	12HP
BM1_6	Indoor ON/OFF simultaneous control	0	Indoor units ON/OFF simultaneous control available (Default)			
		1	Indoor units ON/OFF simultaneous control unavailable			
BM1_7	Defrosting level	0	Ordinary (Default)			
		1	Strengthen defrosting			
BM1_8	Quiet running function	0	Quiet running function is invalid (Default)			
		1	Quiet running function is valid			

Note:

System can not operate without locking, and cannot operate when the locking number is not in accordance with the actual quantity

15. Outdoor digital tube display setting

This AU08NFKERA AU10NFKERA AU12NFKERA have no dial (SW1, SW2, SW3), and the parameter displayed in display tube SMG1, SMG2, so the parameter checked position is SMG1 SMG2.

the parameter entering and setting method as below:

Long press enter (SW7) for 3 seconds to parameter setting interface(in the display tube), the default edit bit is -000 . Short press enter (SW7) to switch the edit bit, short press up (SW4) to increase the data, short press down (SW5) to decrease the data, and short press exit (SW6) to exit.

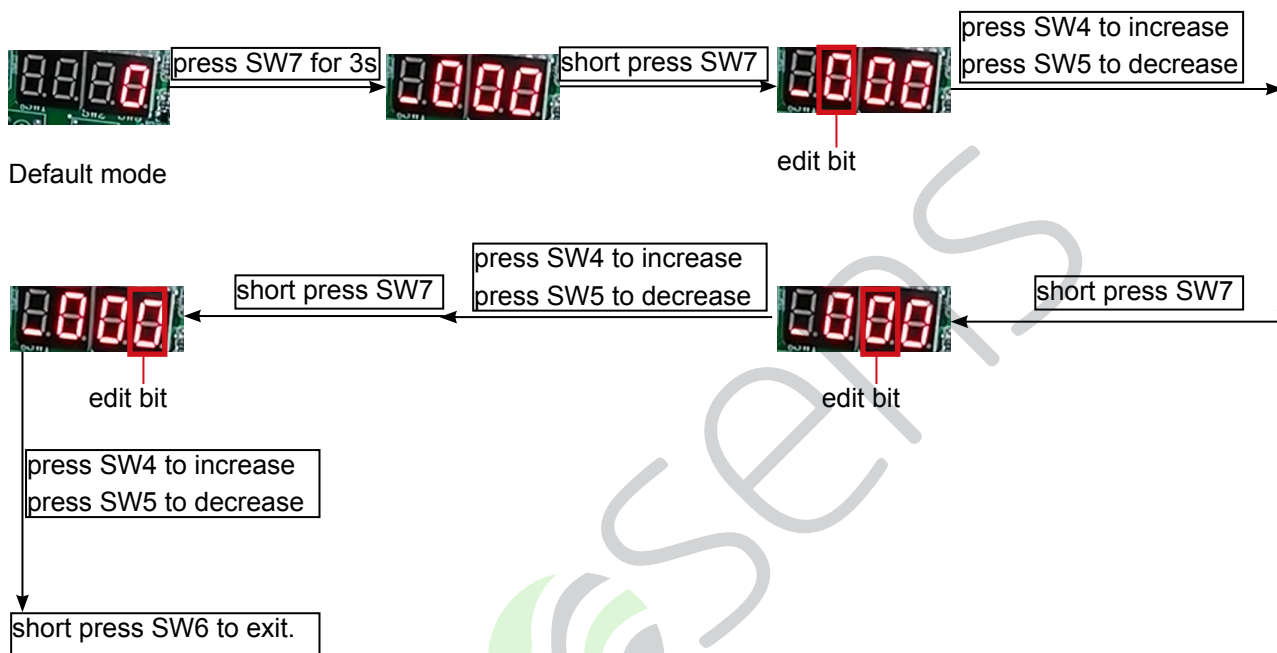

Check the parameters method:

After selecting the corresponding dip switch definition in display tube interface, long press enter (SW7) for 3 seconds to view or modify the parameters. Short press up (SW4) to increase the data, short press down (SW5) to decrease the data, short press exit (SW6) to exit the parameter view or modify .

For example, check the outdoor unit temperature of ambient temperature sensor, the dip switch is 0 1 F

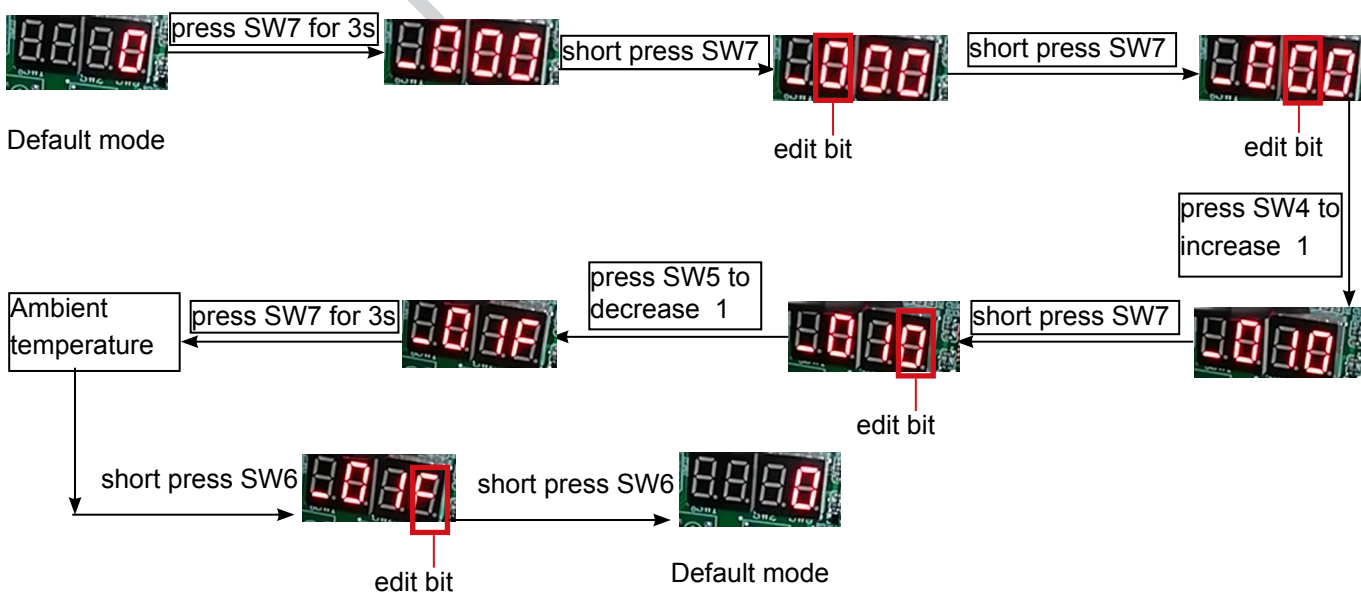

① Indoor unit parameter view

You can view the indoor machine 128 sets of parameters: SMG1-2 and SMG2-1 represent the indoor unit address, SMG2-2 range is 3-14 can view the indoor unit parameters.

SMG1-2	SMG2-1	System Address
0	0-F	1 to 16 (PCB address 0#~15#)
1		17 to 32 (PCB address 16#~31#)
2		33 to 48 (PCB address 32#~47#)
3		49 to 64 (PCB address 48#~63#)
7		65 to 80 (PCB address 64#~79#)
8		81 to 96 (PCB address 80#~95#)
9		97 to 112 (PCB address 96#~111#)
A		113 to 128 (PCB address 112~127#)

SMG2-2	Function	Digital tube SMG1-2 SMG2-1 SMG2-2 display
3	Indoor unit communication check and program version	Communication normal display indoor unit program version (1 decimal), the communication interrupted normal display "0000" (5 consecutive round of no communication success), communication has been abnormal display "---- ---". For example: 3.9, means the indoor unit version is V3.9
4	Indoor unit failure	Display indoor failure code; no failure, display 0
5	Indoor unit capacity	The indoor unit capacity (unit: HP, one decimal), 1.5 HP displays 1.5
6	Indoor EEV open angle	Electronic expansion valve (EEV) open angle (Unit: Pls)
7	Indoor ambient temp. Tai	Ambient temperature (Unit: °C)
8	Indoor gas temperature Tc1	Gas pipe temperature (Unit: °C)
9	Indoor liquid temperature Tc2	Liquid pipe temperature (Unit: °C)
10 (A)	Indoor startup mode, actual fan speed and SCODE code	LD2 indicates startup mode (O: Stop C: cooling H: Heating) LD3 indicates actual fan speed of indoor unit (0 - stop, 1 - low speed, 2 - medium speed and 3 - high speed) LD4 indicate SCODE code (0~15(F)). For example, C3B indicates cooling running at high wind, and the SCODE is 11.
11 (B)	Indoor set temperature Tset	Indoor set temperature (Unit: °C)
12 (C)	Reserve	--
13 (D)	Reserve	--
14 (E)	Forced indoor cooling / heating / stop	(1) press ENTER (SW7) for 3 seconds, to enter setting state, the instruction value is flashing displayed (2) press UP (SW4) or DOWN (SW7) to adjust instruction (COOL/HEAT/OFF). (3) after finish the adjustment, press ENTER (SW7) for 3 seconds, execute the setting instruction and stop flashing

0~3 of SMG1-2 is used to select the outdoor number. SMG2-2 range of 0, 1, 15, observe the outdoor unit parameters. (the master unit can display the parameters of the other outdoor unit and the indoor units, while the slave outdoor only displays its own parameters).

SMG1-2	SMG2-1	SMG2-2	Function	Digital tube SMG1-2 SMG2-1 SM2-2 display
Outdoor unit address 0-3	0	0	Display outdoor unit failure code and Display special running code	<p>Outdoor unit fault code (when the number of indoor units is not locked, Cycle in turn shows "number of indoor units, number of outdoor units, type of power supply".</p> <p>(1) Number of indoor units : " U16" means that the outdoor unit is connected to 16 indoor units.</p> <p>(2) Number of outdoor units :5.5 P. for 150 model.</p> <p>(3) Power type :220 for single phase 220 V, 380 for 3~380 V.</p> <p>Special operating code: DRM1 mode: flashing display "d1"; DRM2 mode: cycle display in turn "d2, compressor frequency"; DRM3 mode: cycle display "d3, compressor frequency" Self-cleaning mode: in cooling display "CLC"," in Heat flashing CLH"</p>
	2	0	Display operation mode	LD2-LD4 means Stop: OFF, Cooling: CCC Heating: HHH, Cooling only : C--- Heat pump: H--
	3	0	Outdoor fan 1 speed	345 representation 345rpm • Press ENTER (SW7) for 3s continuously, display 1111, then to set: flashing. Press UP (SW4) once, fan speed will go up 1 level; press DOWN (SW7) once, fan speed will decrease 1 level.
	4	0	Outdoor fan 2 speed	• Press EXIT (SW6) for 3s continuously, display 0000, then quit the setting condition, and stop flashing.
	5	0	Frequency converter INV1 current frequency	110 representation 110.0Hz • Press ENTER (SW7) for 3 seconds, display 1111, enter the set state: flashing display, each according to the 1 UP (SW4) frequency rise 1Hz, every 1 times DOWN (SW5) frequency drop 1Hz; Long press UP (SW4) or DOWN (SW5) can quickly adjust the frequency. • Press EXIT(SW6) for 3 seconds, display 0000, quit the set state, stop flashing display; (When the system is faulty, the compressor is forbidden to start.)
	7	0	Outdoor unit LEVa1 open degree	Press ENTER (SW7) for 3 seconds, 1111, enter the setting state: flashing, press UP (SW4) valve fully open, press DOWN (SW7) the valve is fully closed; press DOWN (SW7) once, fan speed will decrease 1 level. Press EXIT (SW6) for 3s continuously, display 0000, then quit the setting condition, and stop flashing.
	B	0	Outdoor unit solenoid valve output	LD2: 4WV : 1 ON 0 OFF LD3: SV1 : 1 ON 0 OFF LD4: SV2: 1 ON 0 OFF
	C	0	High voltage switch input	LD2: HPS 1 ON 0 OFF LD3: LPS 1 ON 0 OFF LD4: reserved, display "-"

SMG1-2	SMG2-1	SMG2-2	Function	Digital tube SMG1-2 SMG2-1 SM2-2 display
Outdoor unit address 0-3	E	0	Heater output	LD2: CH1: 1 ON 0 OFF LD3: BH: 1 ON 0 OFF LD4: Reserved, Display “-”
	F	0	Program version	1 means Ver1.0

SMG1-2	SMG2-1	SMG2-2	Function	Digital tube SMG1-2 SMG2-1 SM2-2 display
0	0	1	Pd	Unit: kg, 2 decimal
0	2	1	Ps	
0	3	1	Td	Unit: °C
0	5	1	Tdef	
0	9	1	Tc	
0	1E	1	Ts	

SMG1-2	SMG2-1	SMG2-2	Function	Digital tube SMG1-2 SMG2-1 SM2-2 display
0	0	15 (F)	Reserved	
0	1	15 (F)	Tao	
0	2	15 (F)	Pd_temp	Unit: °C
0	4	15 (F)	Ps_temp	
0	8	15 (F)	Inverter compressor INV1 ON/OFF time	Unit: Min
0	10 (A)	15 (F)	Inverter compressor INV1 current Tm	Unit: A, 1 decimal
0	11 (B)	15 (F)	Unit current input	Unit: A, 1 decimal
0	12 (C)	15 (F)	Inverter compressor INV1 DC voltage	Unit: V
0	13 (E)	15 (F)	Inverter compressor INV1 temperature	Unit: °C

System status display and control (master unit)

SMG1-2	SMG2-1	SMG2-2	Function	Digital tube SMG1-2 SMG2-1 SM2-2 display
0	0	2	Refrigerant type	410A means 410A refrigerant
0	1	2	The outdoor units total capacity in one system	Total outdoor unit capacity (unit: HP) For example: 5.0 means total capacity is 5HP
0	2	2	Total indoor unit capacity	50 means 50HP
0	3	2	The indoor units quantity in one system	For example: 64
0	4	2	Running indoor QTY	Thermostat ON indicates indoor running
0	5	2	Indoor QTY whose operation modes are as the same as that of outdoor	E.g.: 13 indoors
0	6	2	Cooling /Heatingtarget temperature	Unit: °C
0	7	2	Actual average Tc2 temperature	
0	8	2	Automatic recovery of refrigerant Note: after recovery must cancel the setting or re-power on)	Press ENTER (SW7) for 3 seconds, into refrigerant recovery, digital tube display "C0" and" low pressure data" alternately flashing,indicate enter the refrigerant recovery operation, Forced cooling mode, all indoor units open, Do not judge superheat, oil temperature conditions. after 3 mins, Digital tube shows "C1" and" low pressure data "flashing alternately, indicate manual close the liquid pipe stop valve. When Ps≤1 kg(0.1MP _a) , Digital Display C2", indicate manual close the gas pipe stop valve. After 5s, the system stops automatically, Digital Display C3", Power off

SMG1-2	SMG2-1	SMG2-2	Function	Digital tube SMG1-2 SMG2-1 SM2-2 display
0	12 (C)	2	Indoor unit expansion valve fully open	Press ENTER (SW7) for 3 seconds, display 1111, indoor valve fully open Press EXIT (SW6) for 3 seconds, display ----, cancel the forced control of the indoor unit expansion valve.
0	13 (D)	2	All the indoor unit in cooling	Press ENTER (SW7) for 3 seconds, display 1111, open; Press EXIT (SW6) for 3 seconds, ----, close
0	14 (E)	2	All the indoor unit in heating	
0	15 (F)	2	Cancel all manual control (running class)	Press ENTER (SW7) for 3 seconds, display 1111 cancel; or press EXIT (SW6) for 3 seconds, display 0000, cancel Remove all manual control (part), all indoor unit close.

E2 control parameters display and setting

Each need to be set separately, setting method:

- (1) Press ENTER (SW7) for 3 seconds, enter the setting state, flashing display the current value
- (2) Press UP (SW4) or DOWN (SW5) to adjust parameters
- (3) After the adjustment is completed

A> In the current state of the code, press the ENTER (SW7) for 3 seconds within the effective setting time, save the current setting value and exit the setting state, stop the flicker display, wait for 5 seconds and then power up again.

 In the current state of the code, not press ENTER (SW7) or change the dip switch selection, do not save the current set value, exit the setting state, stop flashing display

SMG1-2	SMG2-1	SMG2-2	Function	Digital tube SMG1-2 SMG2-1 SM2-2 display
15 (F)	0	2	Remark of indoor unit adjusting valve when heating standby	0-unavailable 1-available
15 (F)	1	2	Oil return mode select	0- long piping unavailable 1-long piping available
15 (F)	2	2	Area selection	0- American unavailable 1- American available
15 (F)	3	2	Start mode priority	0- first open is priority; 1- last open is priority 2- cooling priority; 3- heating priority
15 (F)	4	2	Capacity over match selection	1- forbidden
15 (F)	5	2	ECO and normal operation selection	0- ECO 1- Normal operation
15 (F)	6	2	Cooling only or heat pump selection	0- Cooling only 1-heat pump
15 (F)	7	2	New and old protocol selection	96-new protocol 24-old protocol
15 (F)	8	2	Fan mode selection	0-normal 1-Energy efficiency testing 2-High ESP
15 (F)	9	2	Modbus protocol selection	0-Modbus protocol 1-Central wired controller protocol
15 (F)	10 (A)	2	Expansion valve LEV fault shield selection	0- not shielded, normal detection 1- shielded
15 (F)	11 (B)	2	Snow-proof operation setting	0-without snow-proof operation, 1-snow-proof operation

SMG1-2	SMG2-1	SMG2-2	Function	Digital tube SMG1-2 SMG2-1 SM2-2 display
15 (F)	12 (C)	2	Power restrain operation control mode selection	0-unavailable 1-available
15 (F)	13 (D)	2	ModeBus Fahrenheit unit selection	0- °C 1- °F
15 (F)	14 (E)	2	Allow access to factory automation test mode mark (for factory testing)	0- forbidden 1- allow(default)
15 (F)	15 (F)	2	Allow access to self-cleaning	0- forbidden 1- allow(default)

Outdoor unit valve control

SMG1-2	SMG2-1	SMG2-2	Function	Digital tube SMG1-2 SMG2-1 SM2-2 display
6	15 (F)	2	Cancel all the manual controls (component type)	<ul style="list-style-type: none"> • Press ENTER (SW7) for 3 seconds, display 1111, then to quit, or press EXIT (SW6) for 3 seconds, display 0000, then quit the set. • Cancel items: Movable component control by hand such as compressor, motor, electronic expansion valve (LEV), solenoid valve (SV) and so on (including evacuation and charging; excluding rated operation, compulsory operation, indoor run/stop, etc.)

Examination of local EE data

SMG1-2	SMG2-1	SMG2-2	Function	Digital tube SMG1-2 SMG2-1 SM2-2 display
12 (C)	0	0	The EE data of address 000H (Version E2)	000H-0FFH address EE data display Address calculation: addr=SMG2-1*10H+SMG2-2 Data display: hexadecimal display, H represents hexadecimal number
	0	1	The EE data of address 001H	
	
	0	F	The EE data of address 00FH	
	1	0	The EE data of address 010H	
	
	1	F	The EE data of address 01FH	
	
13 (D)	F	F	The EE data of address 0FFH	100H-13FH address EE data display Location: addr=100 H SMG2-1*10H+SMG2-2 Data display: hexadecimal display, H represents hexadecimal number
	0	0	The EE data of address 100H	
	0	1	The EE data of address 101H	
	
	3	F	The EE data of address 13FH	
	4	0	The EE data of address 140H	
	
F	F	The EE data of address 1FFH	140H-1FFH address is fault information area	

Indoor and outdoor unit parameters setting and display.

• Check the outdoor and indoor unit parameters:

Long press SW5 for 3 seconds to enter, and the display tube circularly displays 1 =, 2 =, 3 =...

The specific display meaning is shown in Table 1. Short press down SW5 to stay in this step for a long time. Press SW5 again to continue the cycle. Press enter SW7 to exit;

1=	Outdoor program version
2=	INV frequency
3=	Leva open angle
4=	Levb open angle
5=	Pd data
6=	Ps data
7=	Td data
8=	Ts data
9=	Tc data
10=	Te data
11=	Tao data
12=	Tliqc data
13=	Tsco data
14=	CT
15=	Compressor current
16=	Tf data
17=	Fan motor level

Table 1

• Check the indoor unit parameters:

Long press SW6 for 3 seconds to enter. The display tube will give priority to display the indoor unit position with low indoor unit address and the current mode parameters (mode has O: stop, C: refrigeration, H: heating). For example: 00-h (No.0 unit, heating), the parameters then cycle to display 1 =, 2 =, 3 =... The specific display is shown in Table 2).

Short press SW6 to switch and check the parameters of another indoor unit, and cycle from low to high according to the unit address. For example, it becomes 01-h (No.1 unit, heating), and then this indoor unit parameter cycle display appears. Short press SW6 to switch to the next indoor unit. Press SW7 to exit.

1=	Indoor unit program version
2=	Indoor unit capacity(unit: hp)
3=	Tai data
4=	Tc1 data
5=	Tc2 data
6=	Electronica expansion valve open angle

Note:

1) There are 17 parameters in the outdoor unit, and each parameter is displayed for 2 seconds. After 34 seconds, there will be another cycle;

2) Indoor unit parameters can only be switched from low address to high address by short pressing SW6. If the indoor unit has been queried, you can press SW7 to exit and enter again.

16. Outdoor Unit Control

16.1 Compressor startup control

After receiving the outdoor startup instruction, outdoor open SV1 30 seconds and then standby. When startup, the compressor will keep for 3 min at 45rps (when $T_a < 40^\circ\text{C}$) or 3 min at 40rps (when $T_a \geq 40^\circ\text{C}$). In cooling mode, meet running 1min & $(T_d - CT) \geq 20^\circ\text{C}$ or $P_s \leq 0.1\text{MPa}$ (or max. running time is 3min), quite the startup control;

In heating mode, meet running 1min and $(T_d - CT) \geq 20^\circ\text{C}$ or $P_s \leq 0.1\text{MPa}$ (or max. running time is 3min), quite the startup control;

During startup, the high pressure protection, high exhaust protection and current protection is priority and the low exhaust up frequency protection is shielded.

16.2 Compressor output control

Compressor Pd/Ps control, control the compressor frequency to output appropriate cooling/heating capacity.

The control at the end of the startup control.

16.2.1 In cooling mode:

According to the ambient temperature select target Ps automatically

Mode	Effect priority mode (default)	Energy-saving mode	Outdoor ambient temperature	Ps correction during running
Target Ps	Setting value $-R^\circ\text{C}$	Setting value $-R^\circ\text{C}$	$T_a \leq 12^\circ\text{C}$	During running: correct the Ps according to the compression ratio
Target Ps (set by dip switch)	0	2	$12^\circ\text{C} < T_a < 40^\circ\text{C}$	
Target Ps	Setting value $+2^\circ\text{C}$	Setting value $+2^\circ\text{C}$	$T_a \geq 40^\circ\text{C}$	

R value setting: $T_a < -5^\circ\text{C}$, Target Ps: setting value -8°C

$-5^\circ\text{C} \leq T_a < 12^\circ\text{C}$, Target Ps is the slope value of setting value and (setting value -8°C)

16.2.2 In heating mode:

According to the piping length to select target Pd and also according to the ambient temperature select target Pd automatically

Mode	Effect priority mode (default)	Energy-saving mode	Outdoor ambient temperature	Pd correction during running
Target Pd	Setting value $+3^\circ\text{C}$	Setting value $+3^\circ\text{C}$	$T_a \geq 15^\circ\text{C}$	During running: correct the Pd according to the compression ratio
Target Pd	Setting value $+2^\circ\text{C}$	Setting value $+2^\circ\text{C}$	$T_a \geq 7^\circ\text{C}$	
Target Pd (set by dip switch)	48	46	$T_a \geq -5^\circ\text{C}$	
Target Pd	Setting value -2°C	Setting value -2°C	$T_a < -5^\circ\text{C}$	

16.3 Defrosting control

In order to have the effect heating operation, need defrosting control.

16.3.1 Entering condition:

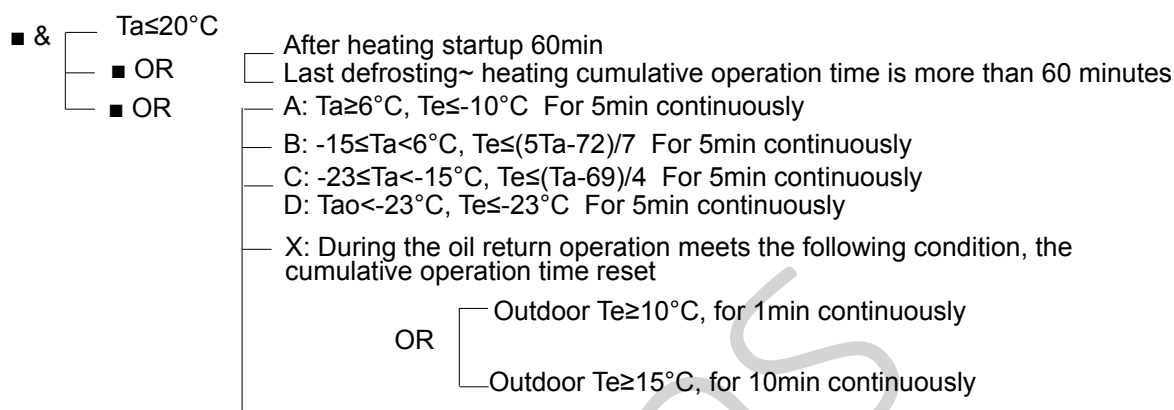

16.3.2 Defrosting control

During defrosting, four-way valve power off, outdoor fan stop, indoor fan stop, outdoor PMV open to 470pls.

3.3 Quit defrosting

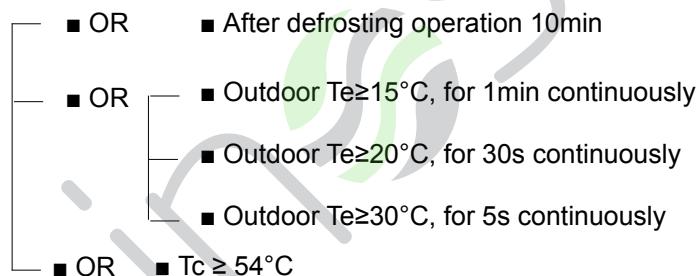

16.4 Oil return control

16.4.1 Entering condition:

A: In cooling mode

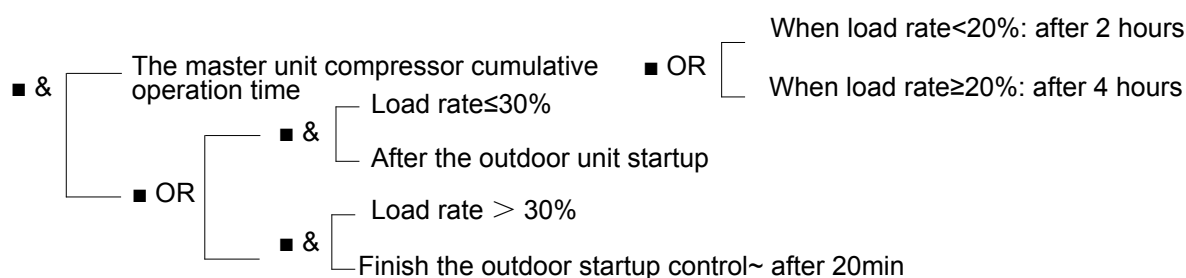

Note: $load\ rate = \frac{\sum indoor\ HP(Thermo\ ON)}{\sum indoor\ HP} * 100\%$

B: In heating mode

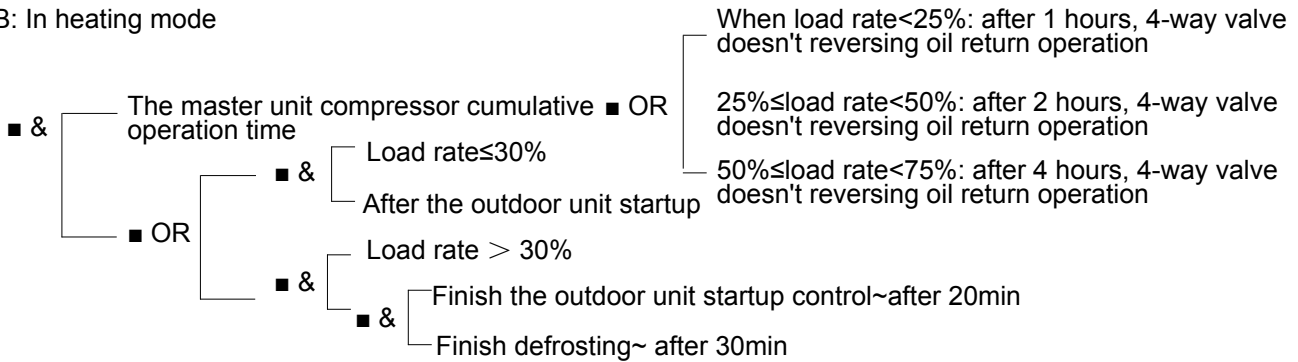

Note: if load rate $\geq 75\%$ and the outdoor unit output rate $\geq 75\%$ for 10 min, oil return time reset

16.4.2 Oil return control

- 1) Oil return in cooling mode, the compressor according to the 75% of maximum frequency control, the outdoor PMV opening angle is 470 pls, the Thermo ON indoor PMV opening angle is 250 pls, the Thermo OFF indoor PMV opening angle is 125 pls.
- 2) Oil return in heating mode (4-way valve reversing), the compressor according to the 75% of maximum frequency control, the outdoor PMV opening angle is 470 pls, the Thermo ON and Thermo OFF indoor PMV opening angle is 125 pls. When $T_d > 95^\circ\text{C}$ and $T_d\text{SH} > 15^\circ\text{C}$, the indoor PMV opening angle increased 10%, max. time is 2; When $T_d < 90^\circ\text{C}$, return to the usually opening.
- 3) Oil return in heating mode (4-way valve doesn't reversing), the compressor according to the indoor units load rate and current running frequency to confirm the oil return enter frequency, the maximum frequency can't exceed 75% of the maximum frequency. the PMV of the outdoor and the Thermo ON indoor unit control automatically, Thermo OFF indoor PMV opening angle is 250 pls.

16.4.3 Oil return quit condition:

1) In cooling mode

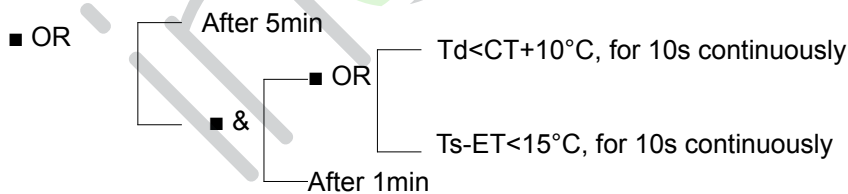

2) In heating mode (4-way valve reversing)

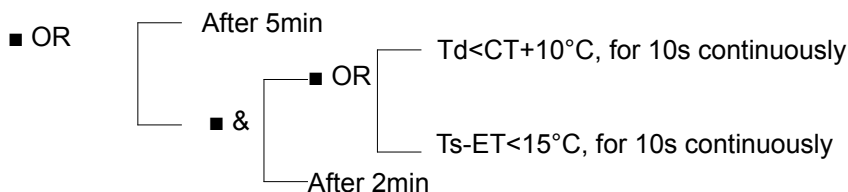

3) In heating mode (4-way valve doesn't reversing)

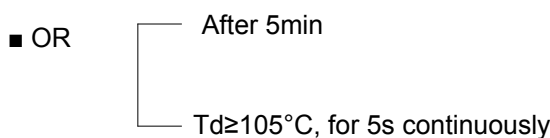

17. Failure Code

Inverter outdoor unit failure code

Digital tube indication on master unit	Indication on wired controller (hex)	Failure code definition	Failure description	Remarks
20-0	14	Defrosting temp. sensor (Te) failure	Continuous disconnect for 60 seconds or short circuit, failure alarm	Resumable
21	15	Ambient temp. sensor (Ta) failure	Continuous disconnect for 60 seconds or short circuit, failure alarm	Resumable
22	16	Suction temp. sensor Ts failure	AD value is below 11(open circuit) or over 1012(short circuit) for 60seconds, in defrosting and within 3 minutes after defrosting, no alarm	Resumable
23	17	Discharging temp. sensor Td failure	After compressor is running for 5 minutes, AD value is below 11(open circuit) or over 1012(short circuit) for 60seconds, in course of startup, defrosting and within 3 minutes after defrosting, no alarm	Resumable
26-0	1A	Communication failure with indoor units	No indoor units connection can be detected for continuous 200 seconds.	Resumable
26-1	1A	Number of indoor units less than connected indoor units	It was detected that the number of indoor units was less than the set number for 300 seconds.	
26-2	1A	Number of indoor units more than connected indoor units	It was detected that the number of indoor units was more than the set number for 300 seconds.	
28	1C	Discharge pressure sensor (Pd) failure	Continuous disconnect for 60 seconds or short circuit, failure alarm.	Resumable
29	1D	Suction pressure sensor (Ps) failure	Continuous disconnect for 60 seconds or short circuit, failure alarm.	Resumable
30	1E	High pressure switch (HPS) failure	When the high pressure switch is disconnected, failure alarm. When the high pressure switch is closed, failure removed. Failure is locked if it occurs 3 times in one hour.	Once failure locked, un-resumable.
33	21	EEPROM failure	Outdoor unit EEPROM failure	Un-resumable
34	22	Discharge temp. too high (Td)	$T_d \geq [115]^{\circ}\text{C}$, failure alarm; $T_d \leq [85]^{\circ}\text{C}$, failure removed. Failure is locked if it occurs 3 times in one hour.	Once failure locked, un-resumable
35	23	4-way valve revering failure	After the compressor starts, it runs continuously for 10 minutes, if the 4-way valve does not reverse, failure alarm. The failure will be removed after 3 minutes. Failure is locked if it occurs 3 times in one hour.	Once failure locked, un-resumable
39-0	27	Suction pressure (Ps) too low	(1) Cooling: $P_s \leq 0.05 \text{ MPa}$ or $P_s \leq 0.1 \text{ MPa}$ for 5 consecutive minutes, failure alarm. $P_s \geq 0.25 \text{ MPa}$, failure removed. (2) Heating: $P_s \leq 0.03 \text{ MPa}$ or $P_s \leq 0.05 \text{ MPa}$ for 5 consecutive minutes, failure alarm. $P_s \geq 0.2 \text{ MPa}$, failure removed. Failure is locked if it occurs 3 times in one hour.	Once confirmation, un-resumable

Digital tube indication on master unit	Indication on wired controller (hex)	Failure code definition	Failure description	Remarks
39-1	27	Compression ratio (ϵ) too high	Compression ratio (ϵ) ≥ 12.0 for 5 consecutive minutes, failure alarm. The failure will be removed after 3 minutes. Failure is locked if it occurs 4 times in 2 hours.	Once failure locked, un-resumable.
40	28	Discharge pressure (Pd) too high	$P_d \geq 4.15\text{MPa}$ or $P_d \geq 3.9\text{MPa}$ for 5 consecutive minutes, failure alarm. $P_d \leq 3.3\text{MPa}$, failure removed. Failure is locked if it occurs 3 times in one hour.	Once failure locked, un-resumable.
43	2B	Discharge temp. too low protection (Td)	$T_{dSH} \leq 10^\circ\text{C}$ for 5 consecutive minutes, failure alarm. After the oil temperature is satisfied, the failure will be removed. Failure is locked if it occurs 3 times in one hour.	Once failure locked, un-resumable.
46	2E	Communication failure with inverter module	No module board signal is received within 30 seconds or data error. It will be automatically restored after receiving correctly.	Resumable
51-0	33	LEV a over current	LEV driver chip detection	Resumable
51-2	33	LEV b over current	LEV driver chip detection	Resumable
52-0	34	LEV a circuit open failure	LEV driver chip detection	Resumable
52-2	34	LEV b circuit open failure	LEV driver chip detection	Resumable
53	35	CT current too low or current sensor failure	1. When the compressor runs continuously for 1 minute, the compressor frequency ≥ 50 Hz for 5 minutes. If the current sensor sampling value is less than 10, failure alarm. The failure will be removed after 3 minutes. 2. When the compressor stops, the failure will alarm if $CT > 6\text{A}$ lasts for 3min. The failure will be removed after 3 minutes.	Resumable
58	3A	Sub-cooling temp. sensor T _{sco} temp. sensor failure	Continuous disconnect for 60 seconds or short circuit, failure alarm.	Resumable
59	3B	Sub-cooling temp. sensor T _{liqsc} temp. sensor failure	Continuous disconnect for 60 seconds or short circuit, failure alarm.	Resumable
64	40	CT value too high	When the CT current exceeds the specified value for 5 consecutive seconds, failure alarm. The failure will be removed after 3 minutes. Failure is locked if it occurs 3 times in one hour.	Once failure locked, un-resumable.

Digital tube indication on master unit	Indication on wired controller (hex)	Failure code definition	Failure description	Remarks
71-0	47	Upper DC Fan failure	The failure will alarm when it runs below 20 rpm for 40 seconds or below 20% of the target value for 2 minutes. The failure will be removed after 3 minutes. Failure is locked if it occurs 3 times in one hour.	Once failure locked, un-resumable.
71-1	47	Lower DC Fan2 failure		
78	4E	Lack of refrigerant	1.Cooling: $P_s \leq 0.2\text{MPa}$ for 30 consecutive minutes, failure alarm. $P_s \geq 0.3\text{MPa}$ for 30 consecutive minutes, failure removed. 2.Heating: Both LEVa equals to 470pls and $T_s - P_s \geq 20^\circ\text{C}$ for 60 consecutive minutes, failure alarm. $P_s \geq 0.2\text{MPa}$ for 30 consecutive minutes, failure removed.	Resumable
81	51	Inverter module temp. too high	Inverter temp. $\geq 90^\circ\text{C}$, failure alarm. Inverter temp. $\leq 70^\circ\text{C}$, failure removed. Failure is locked if it occurs 3 times in one hour.	Once failure locked, un-resumable.
82	52	Compressor over current protection	When the compressor current exceeds the specified value for 5 consecutive seconds, failure alarm. The failure will be removed after 3 minutes. Failure is locked if it occurs 3 times in one hour.	Once failure locked, un-resumable.
83	53	Model setting error	Model setting does not match the outdoor unit.	Once failure locked, un-resumable.
110	6E	The inverter module over current (hardware)	Module hardware over current. Failure is locked if it occurs 3 times in one hour.	Once failure locked, un-resumable.
			Instantaneous over current of hardware at rectifier side of inverter module. Failure is locked if it occurs 3 times in one hour.	
111	6F	Compressor out of control	During start-up or operation, the rotor position cannot be detected for 6 consecutive times, failure alarm. The inverter module will be automatic recovery after compressor stops for 5 seconds.	Resumable
112	70	The temp. of the inverter module radiator is too high	The temp. of the inverter module radiator $\geq 94^\circ\text{C}$, failure alarm. The temp. of the module radiator $< 94^\circ\text{C}$, the inverter module will be automatic recovery.	Resumable
114	72	The inverter input power voltage is abnormal	The voltage $< \text{DC}420\text{V}$, failure alarm. The voltage $> \text{DC}420\text{V}$, the inverter PCB will be automatic recovery.	Resumable
			The voltage $> \text{DC}642\text{V}$, failure alarm. The voltage $< \text{DC}642\text{V}$, the inverter module will be automatic recovery.	Resumable
			The power supply of inverter module is interrupted instantaneously.	Resumable

Digital tube indication on master unit	Indication on wired controller (hex)	Failure code definition	Failure description	Remarks
116	74	Abnormal communication between the inverter module and the control PCB	If no communication signal is detected for 30 seconds, , failure alarm.After detection, inverter module will recover immediately.	Resumable
117	75	The inverter module over current (software)	Module rectifier side software instantaneous overcurrent	Resumable
			Inverter Module overload	Resumable
			Module software over current	Resumable
118	76	Compressor startup failed	The compressor failed to start continuously for 5 times.	Resumable
119	77	Current detection circuit failure	The module rectifier side current detection circuit is abnormal.	Resumable
			The sensor used for current detection of inverter controller is abnormal, disconnected or connected incorrectly.	Resumable
121	79	Power supply of inverter module board is abnormal	Power supply of inverter board is broken down instantly.	Resumable
122	7A	The temp. sensor of inverter module is abnormal.	The resistance of inverter temperature sensor is abnormal or not connected.	Resumable
124	7C	Inverter module power supply failure	inverter power supply failure	Resumable

In case of no failure, if the starting conditions of the system are not met, the digital tube of the outdoor unit will display the standby code of the air conditioner:

555.0	Standby state of capacity over-matched	The ratio of indoor capacity to outdoor capacity is over 130%.	Resumable
555.1	Heating at high ambient temp.	Ta>27°C, the indoor units standby when they are running in heating mode.	
555.3	Cooling at ambient temp. too high or too low	Ta>54°C or Ta<-10°C, the indoor units standby when they are running in cooling mode.	
555.b	The running mode of outdoor unit does not match with the indoor units.	The outdoor unit maybe setted to cooling only or heating only.	

18. Troubleshooting

[20~24] Temperature sensor failure

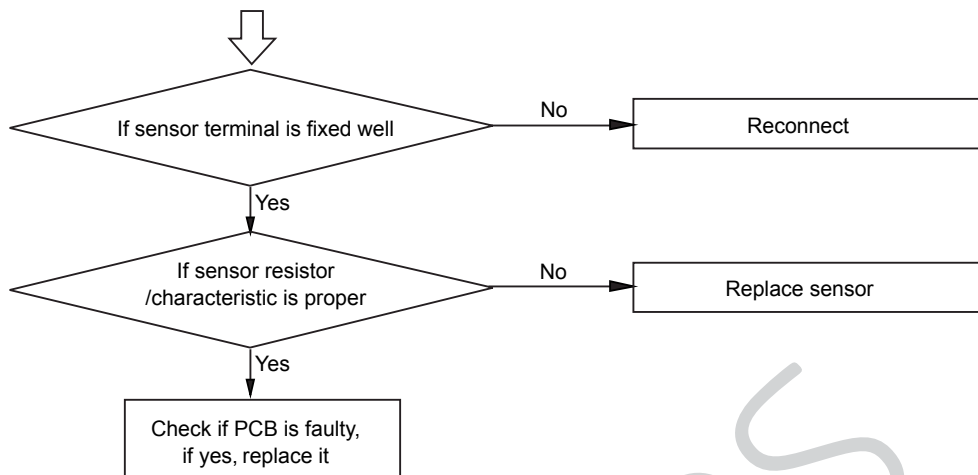

[28, 29] High/low pressure sensor failure

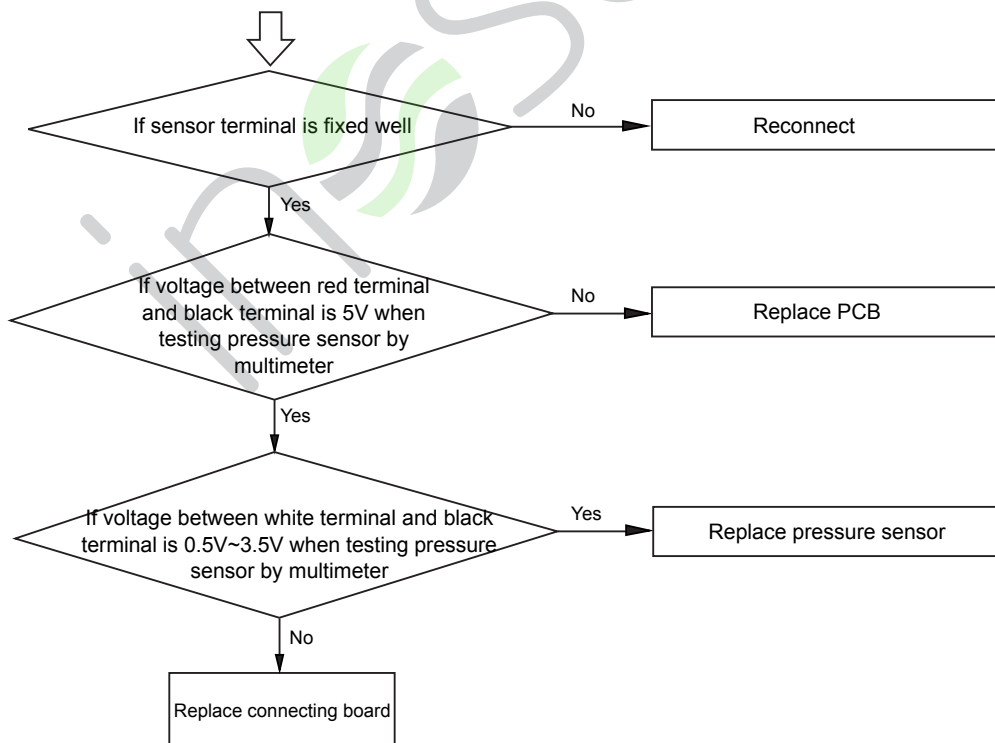

[26-0, 26-1, 26-2] Communication circuit between indoor and outdoor

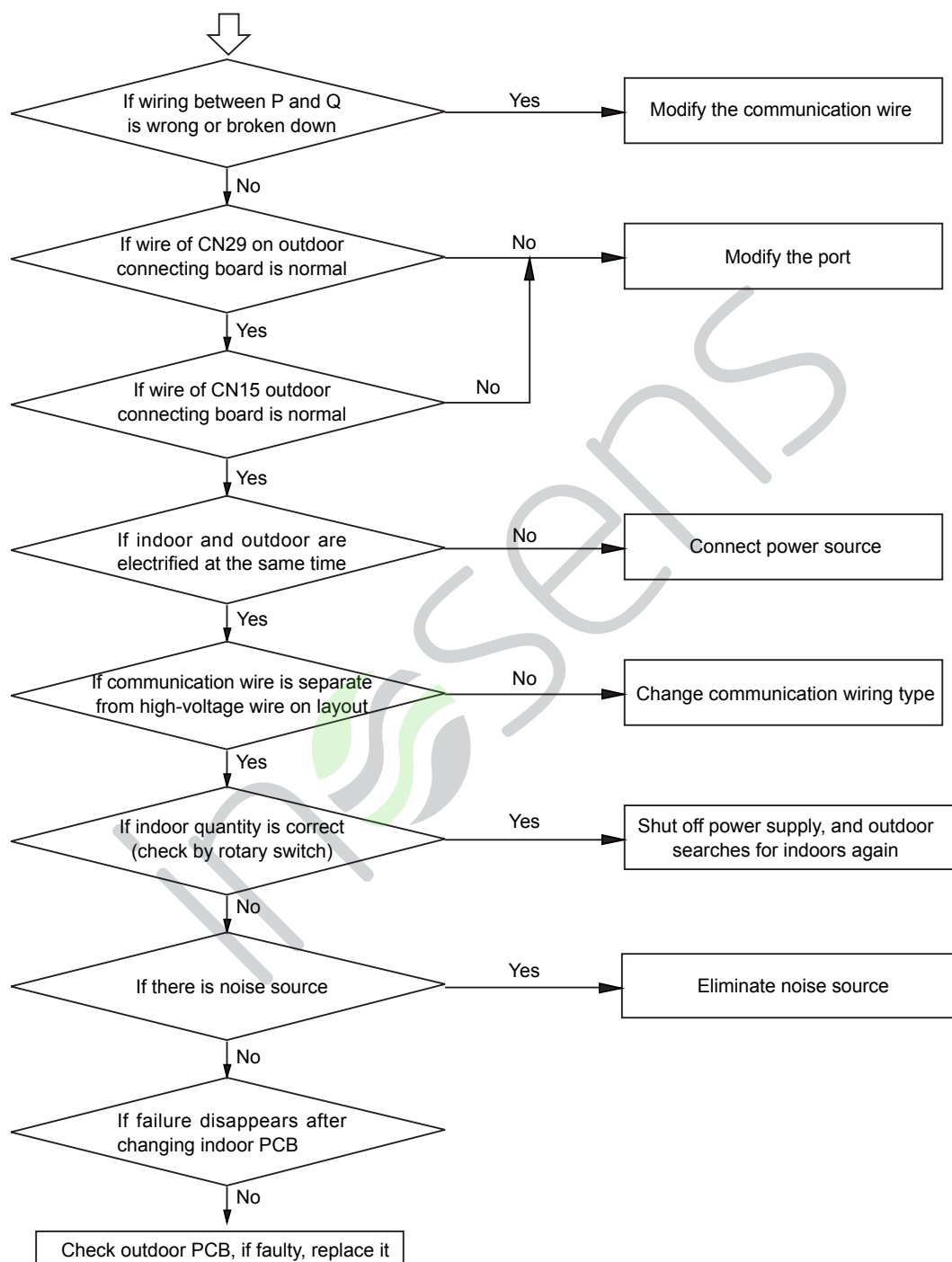

[33] Outdoor EEPROM failure

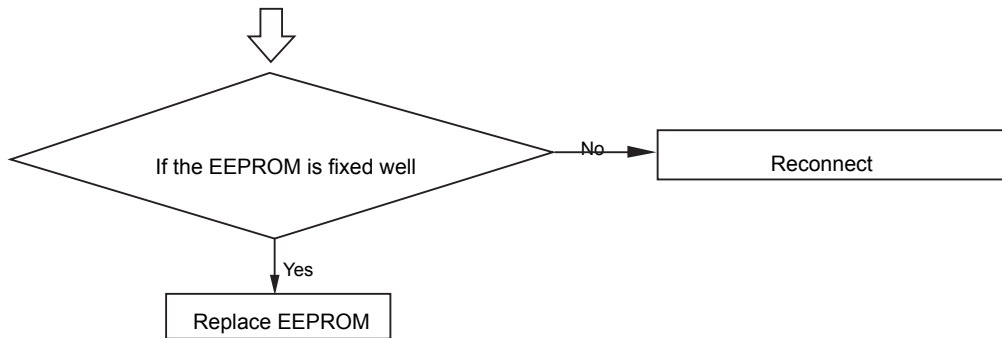

[35] 4-way valve reversing failure

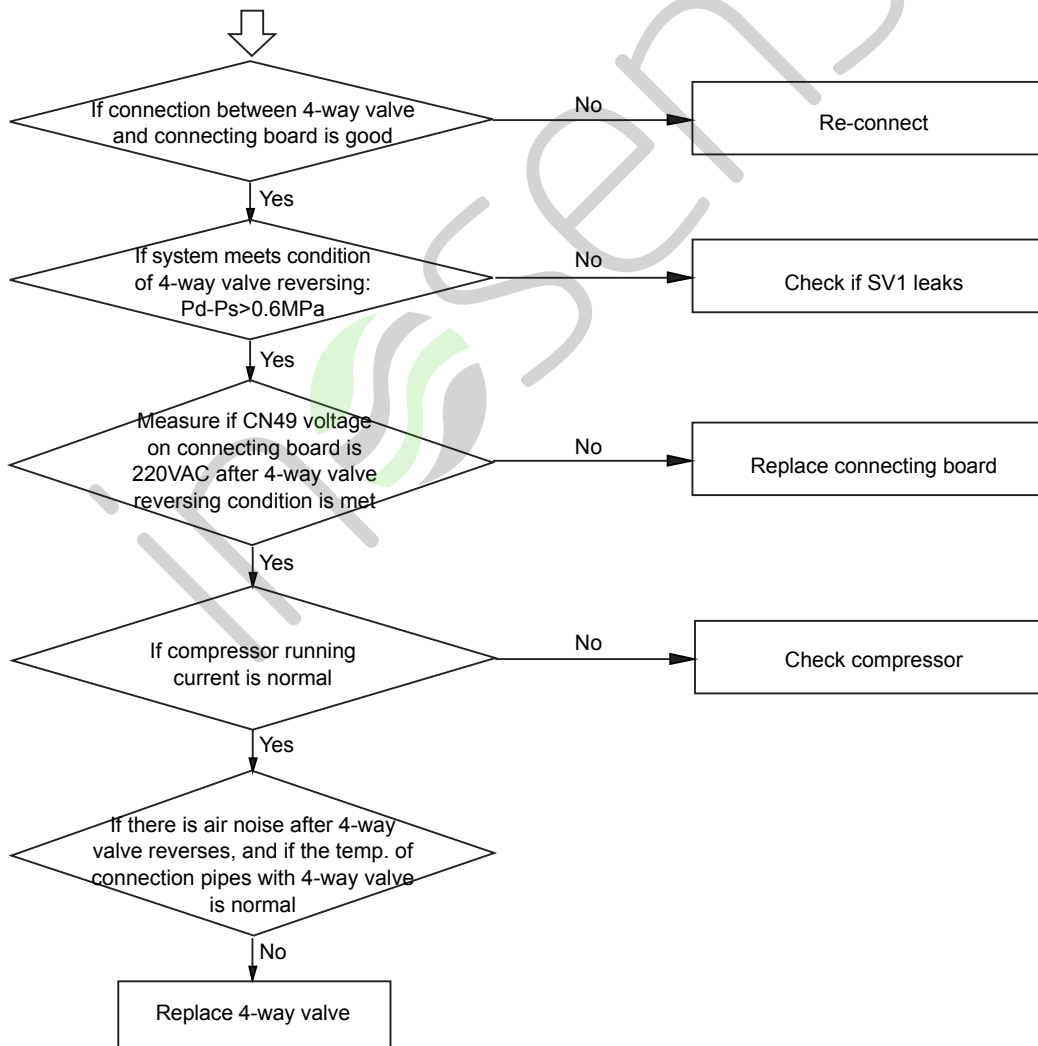

[30] High pressure switch shutoff failure

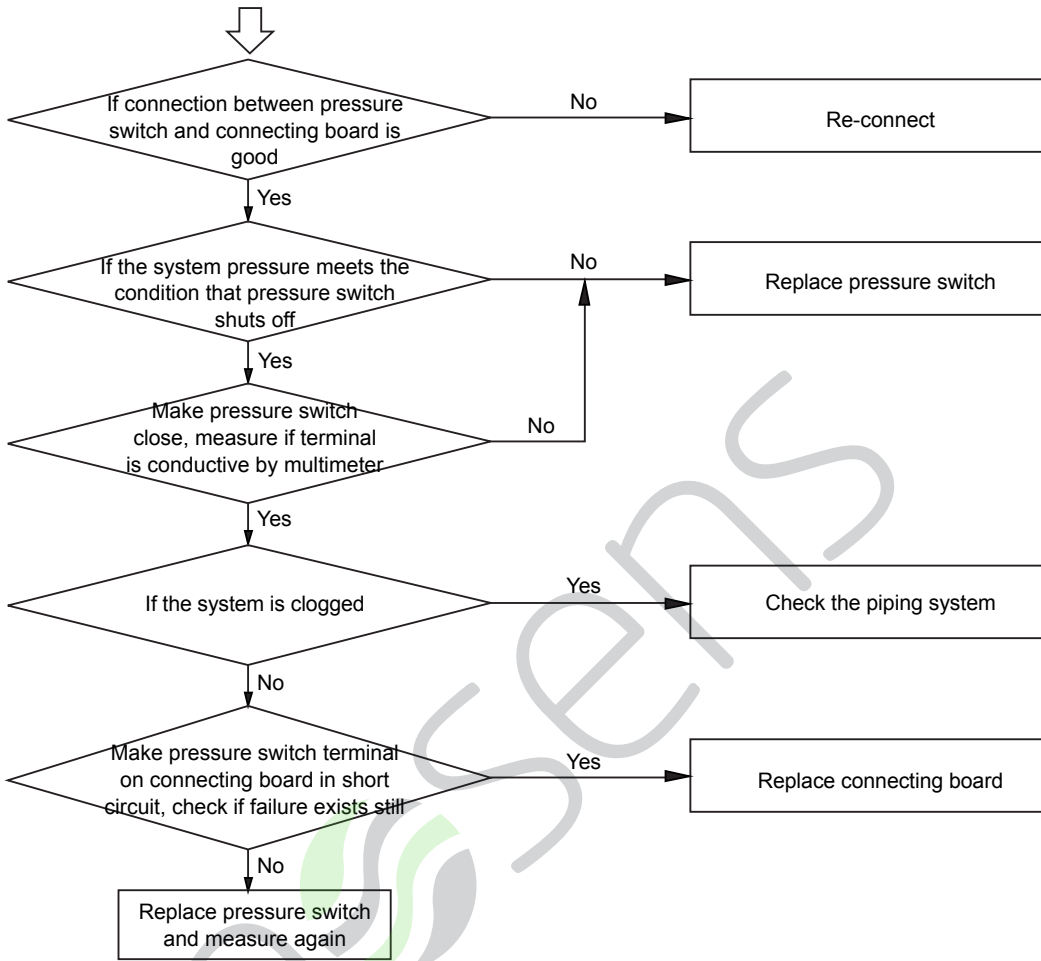

[34] Protection of discharging temp. too high

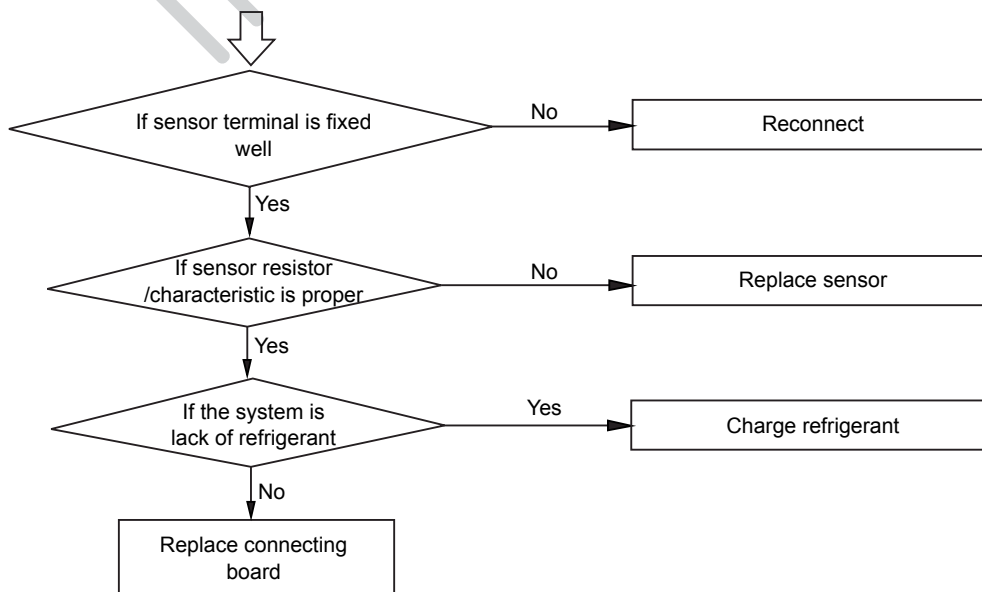

[36] Protection of oil temperature too low

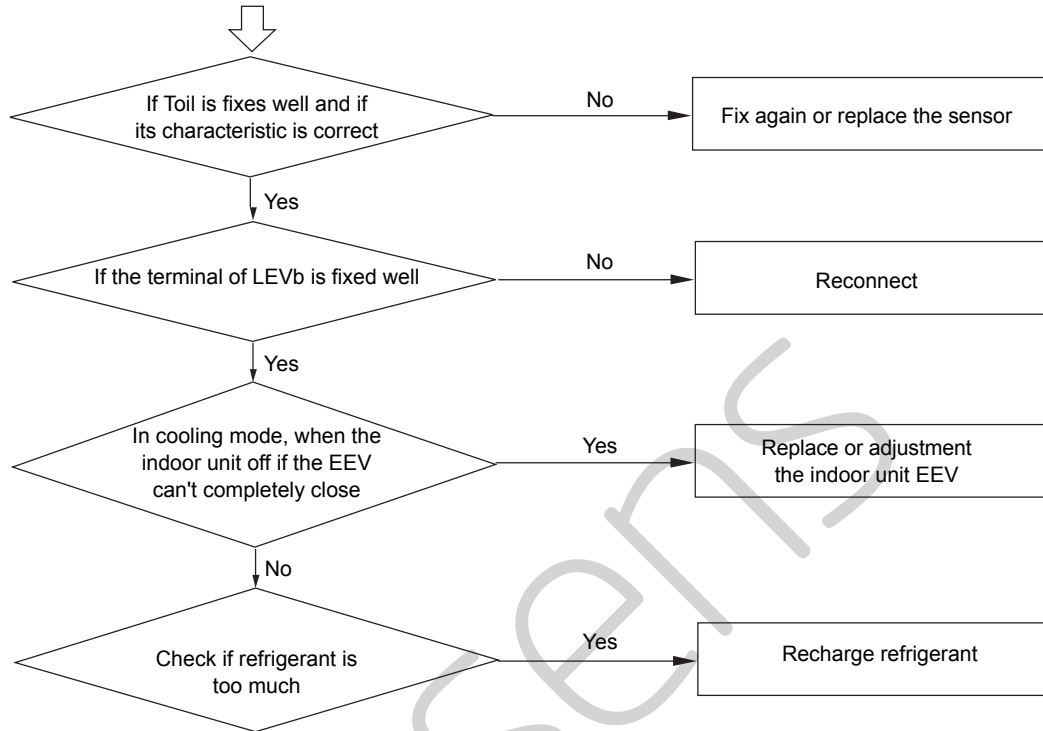

[39-0, 39-1] Low pressure too low and compression ratio too high

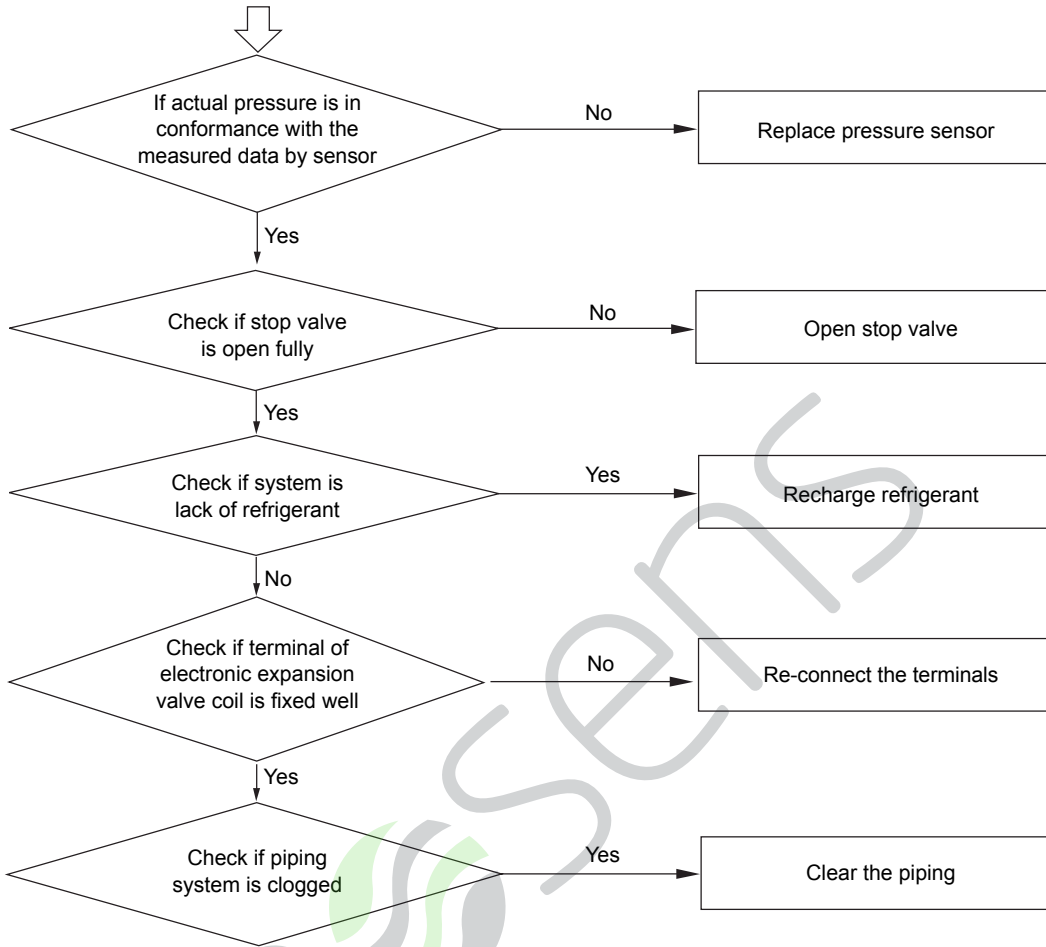

[39-2] Compression ratio too low

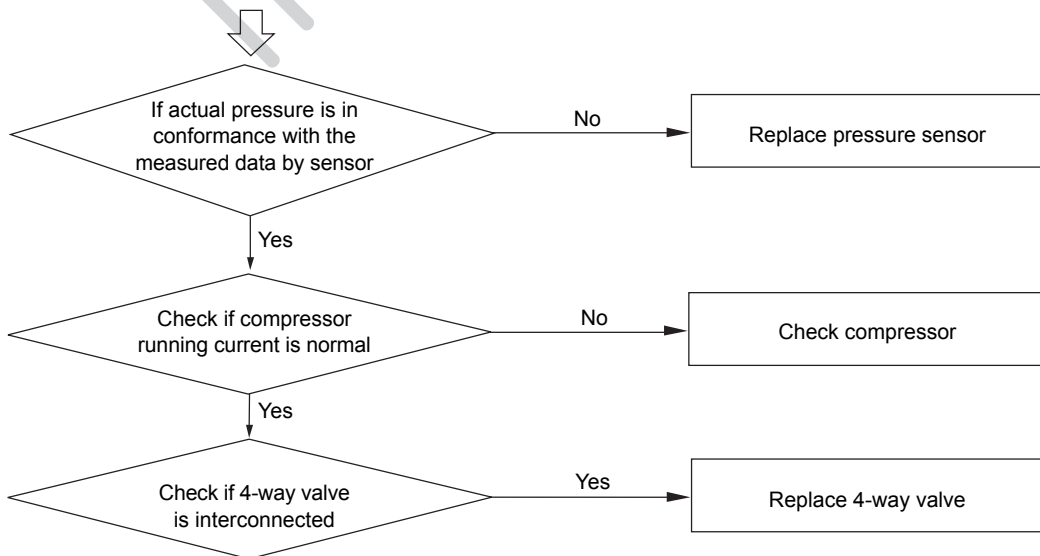

[40] High pressure protection

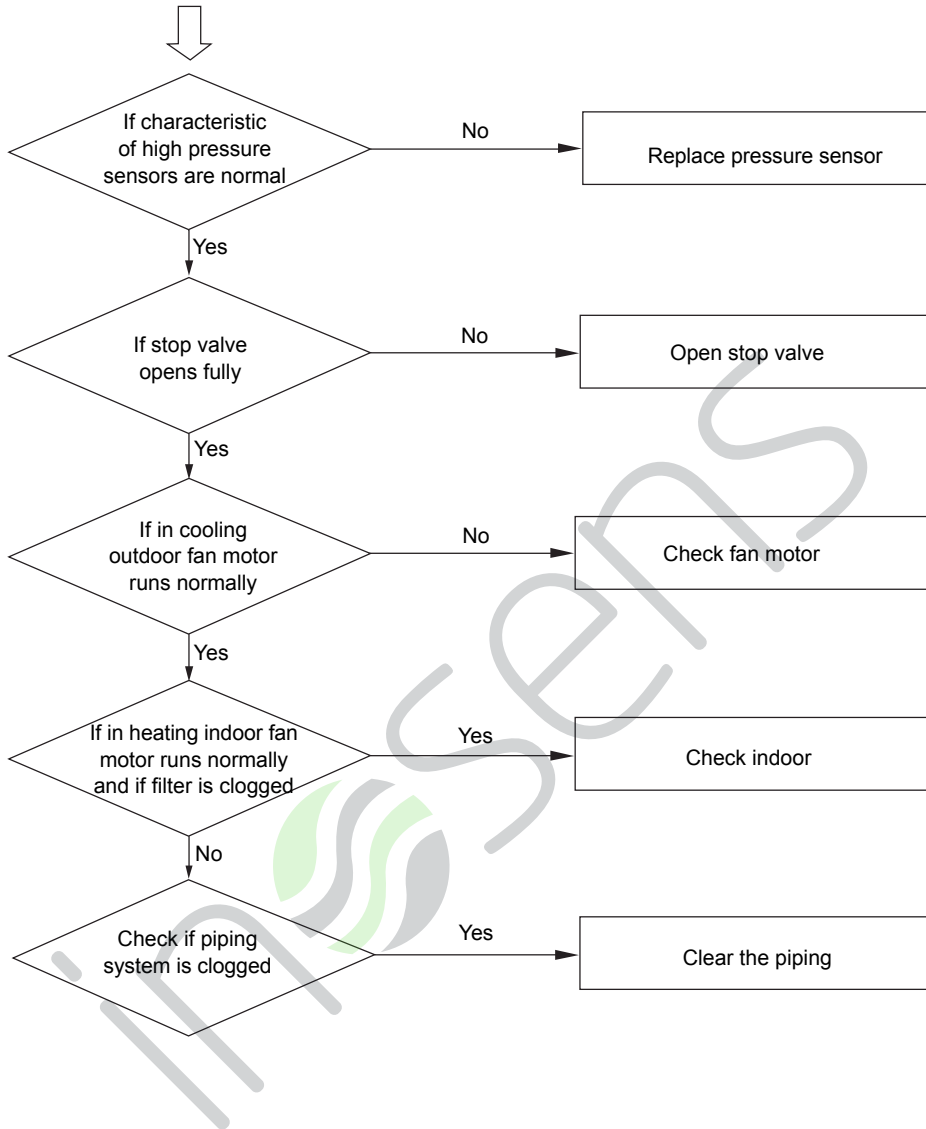

[43] Discharging temp. sensor Td too low protection

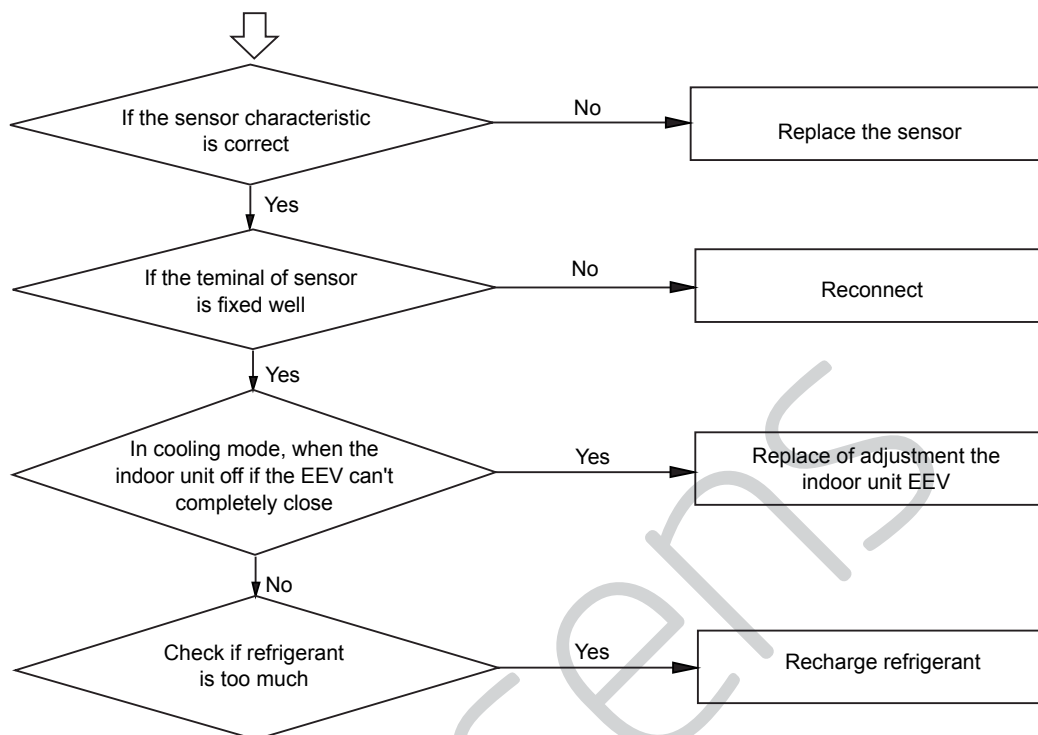

[46] Communication with inverter module failure

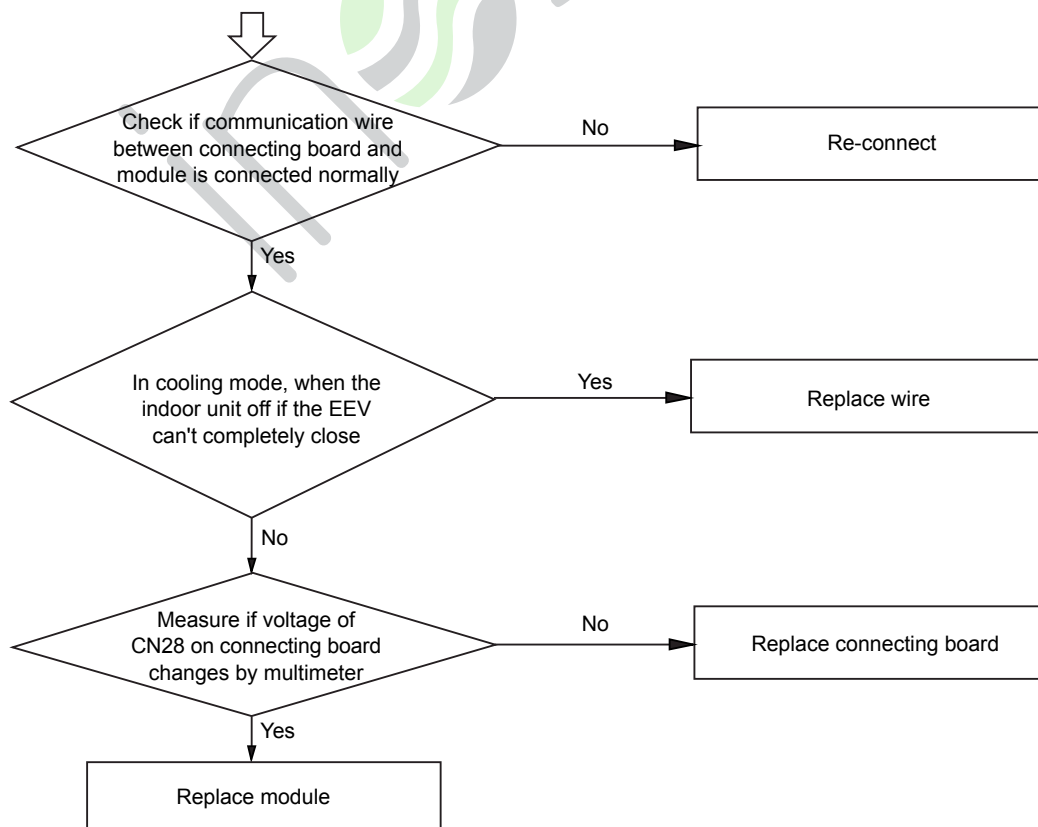

[49] Low pressure switch failure

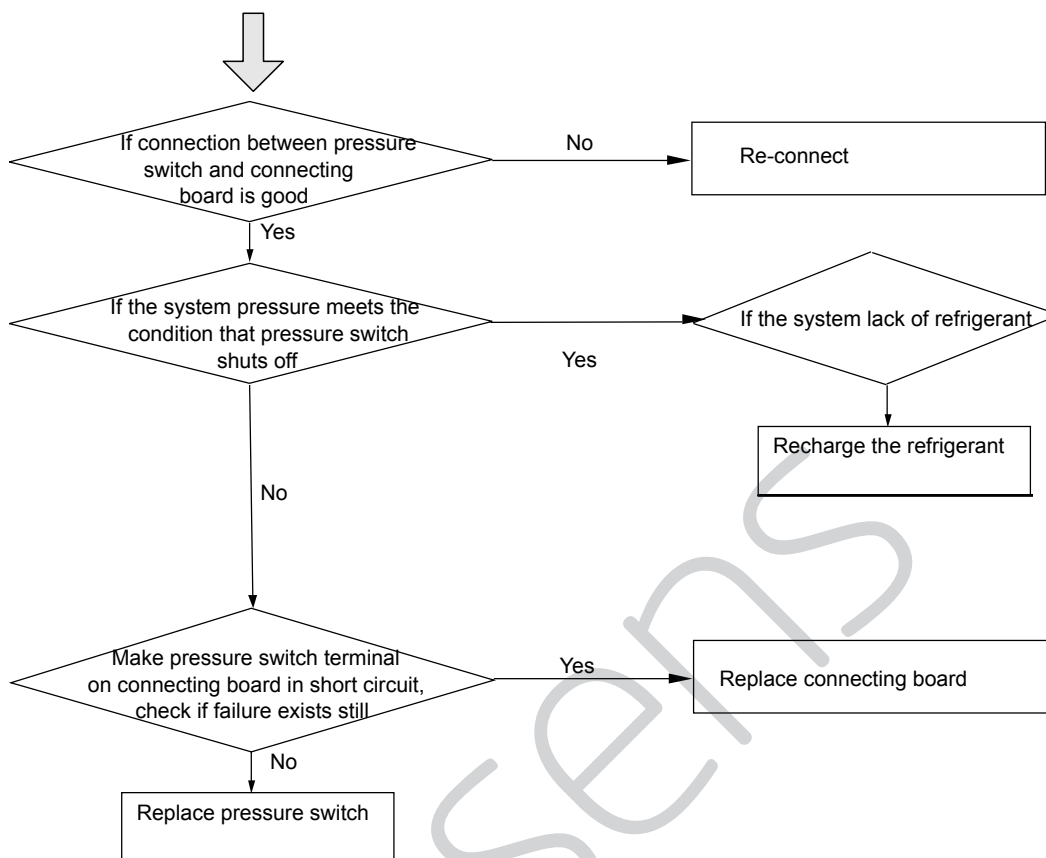

[53] Current sensor failure

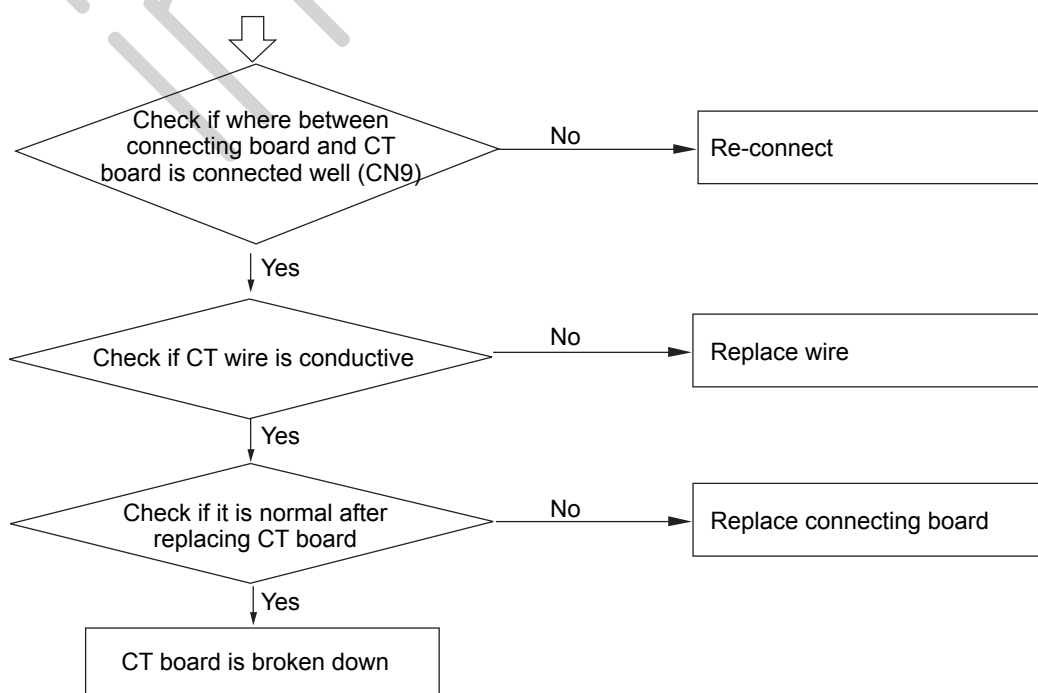

[64] CT over current

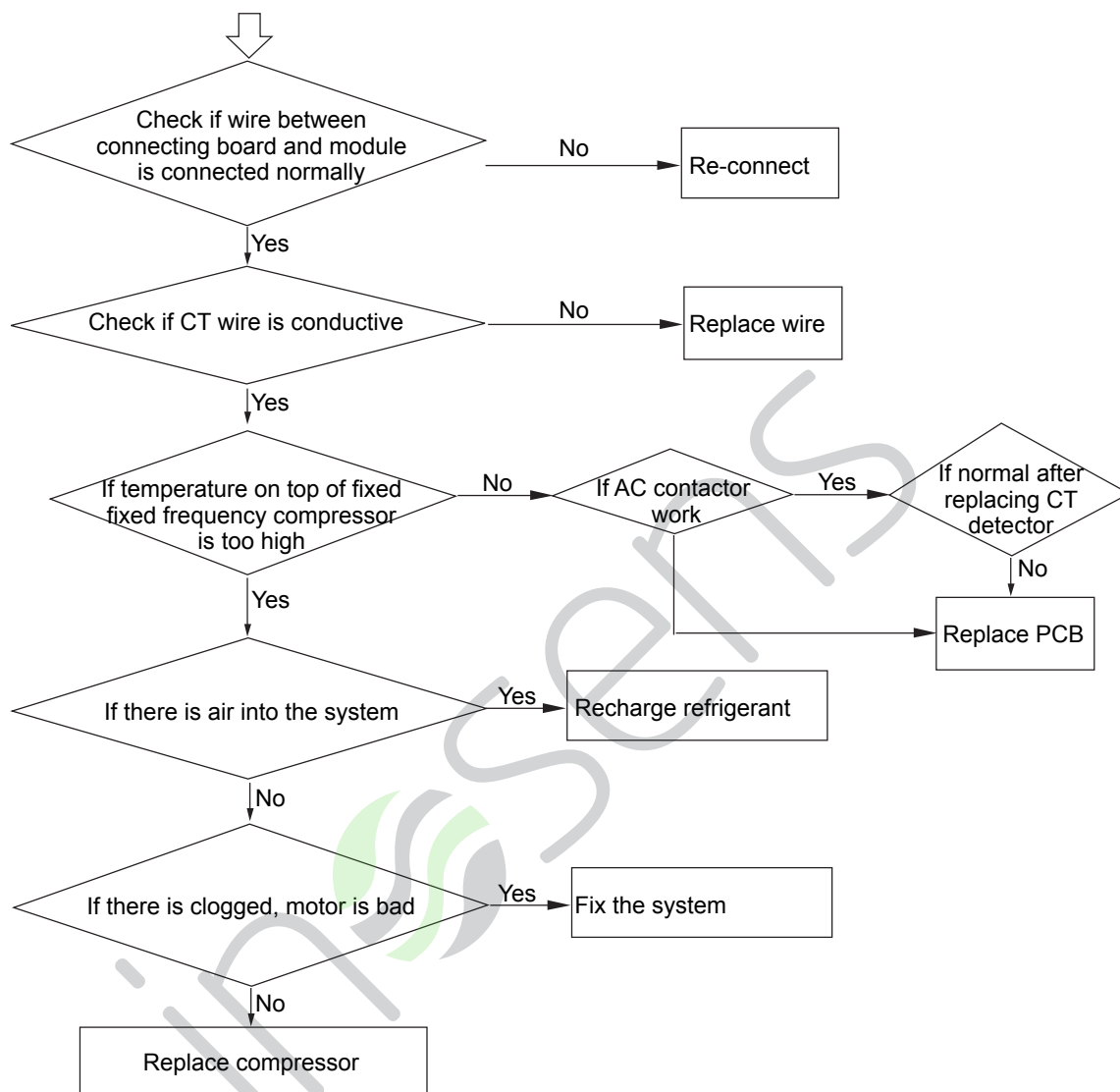

[71] DC motor blocked

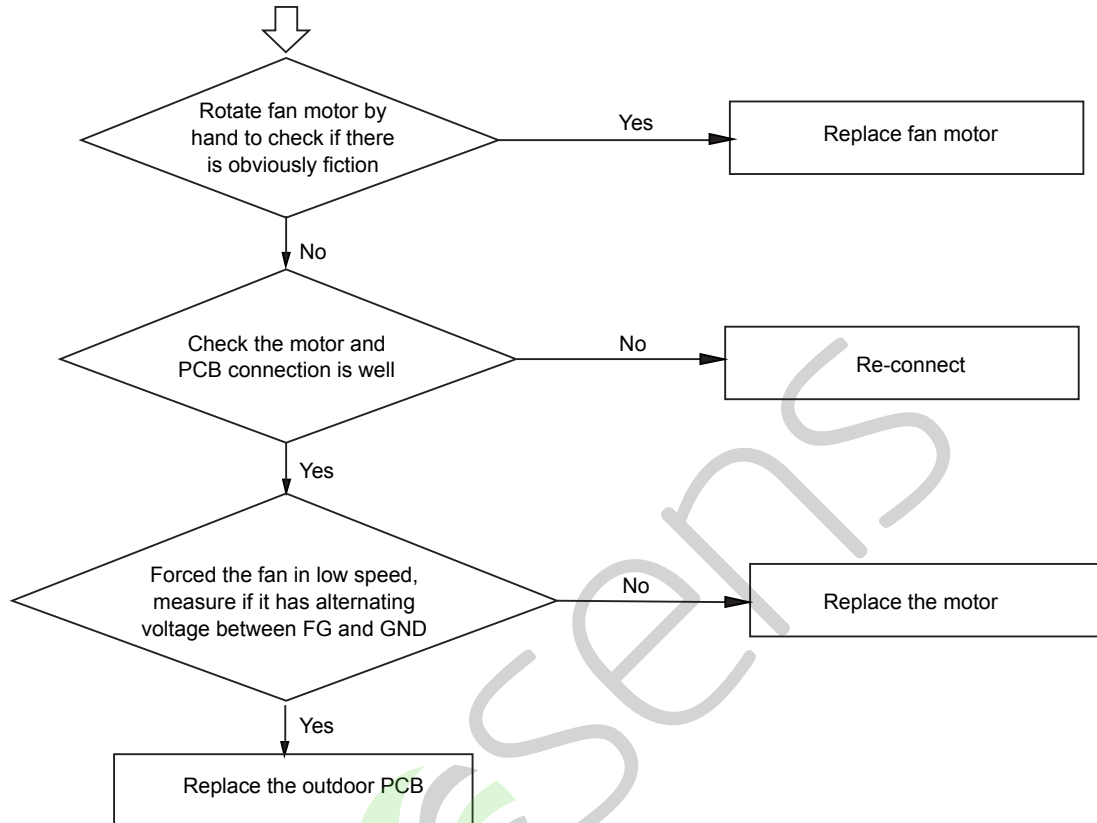

[75] No pressure drop between high pressure and low one

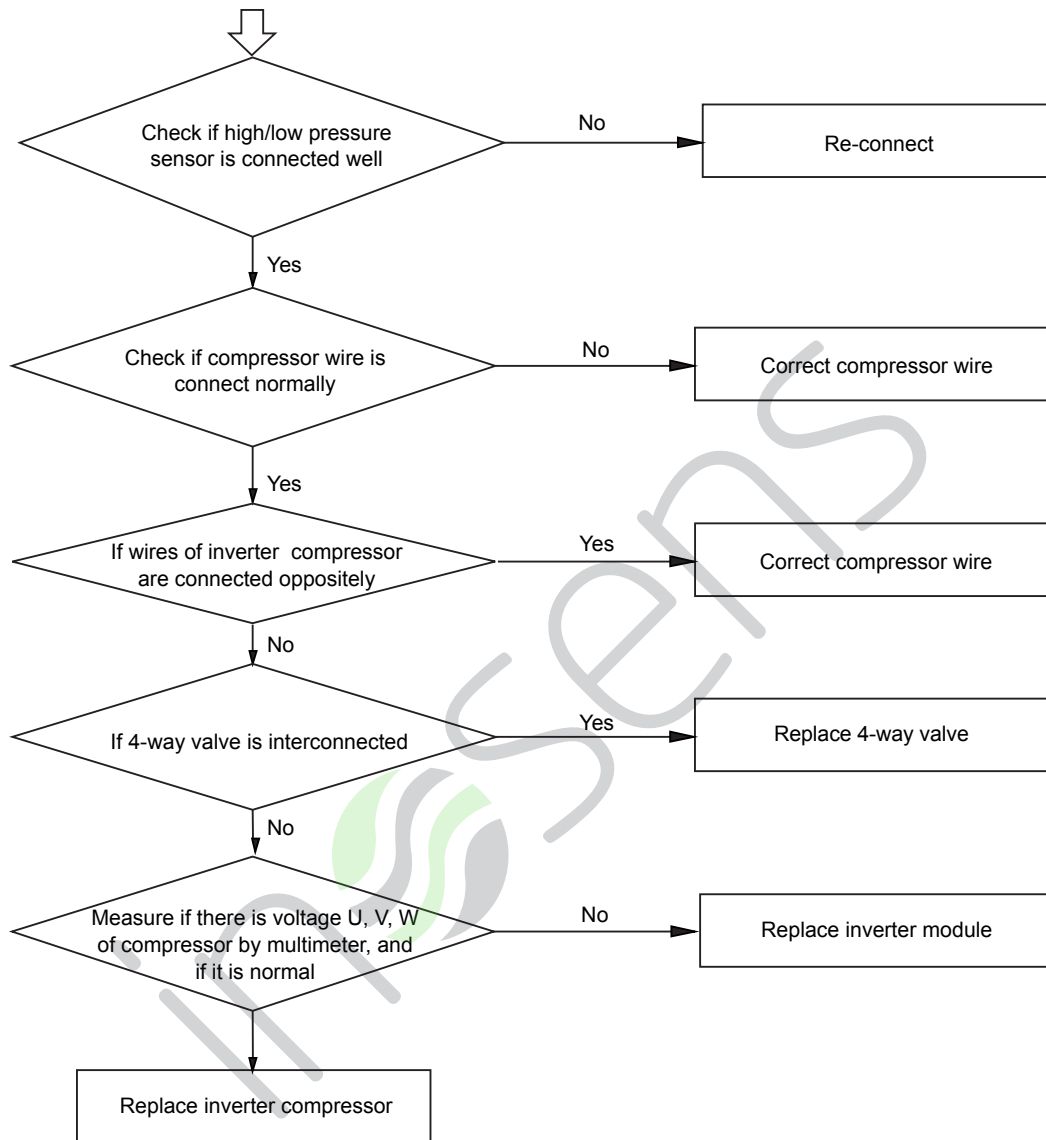

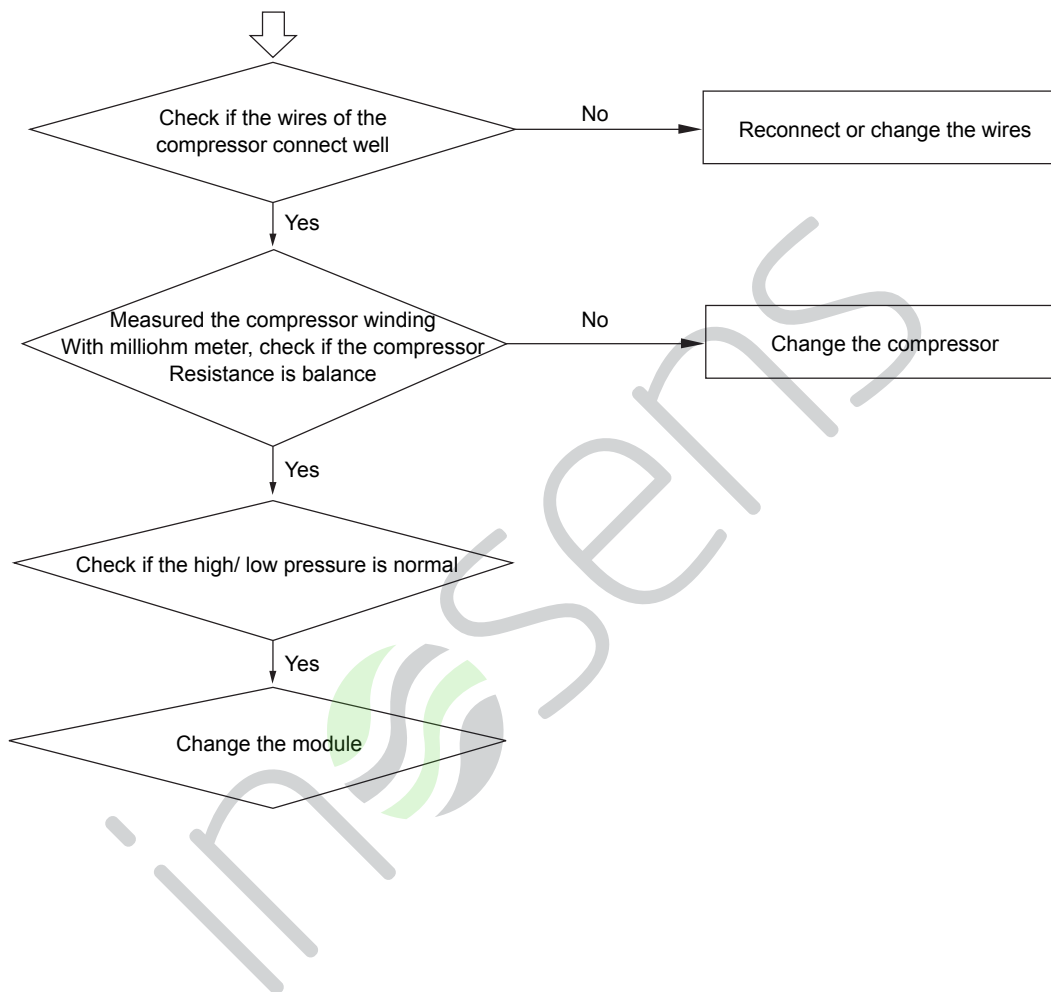
[82] Compressor current protection**[108] Transient over current in IPM module rectifier side software****[109] Current detection circuit abnormality****[123] Transient over current in IPM module rectifier side hardware**

[110] Power module overcurrent

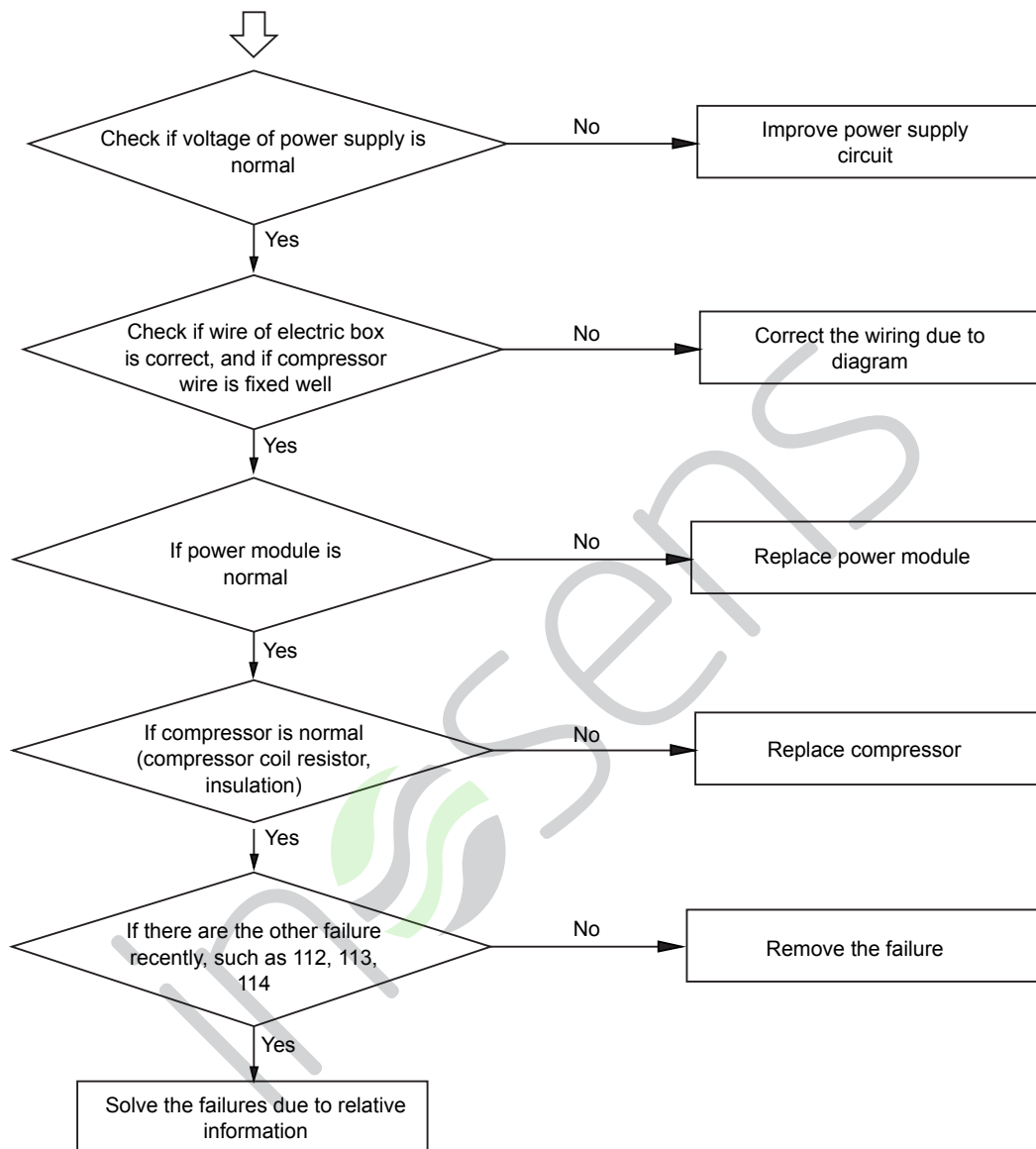

[111] Compressor out of control

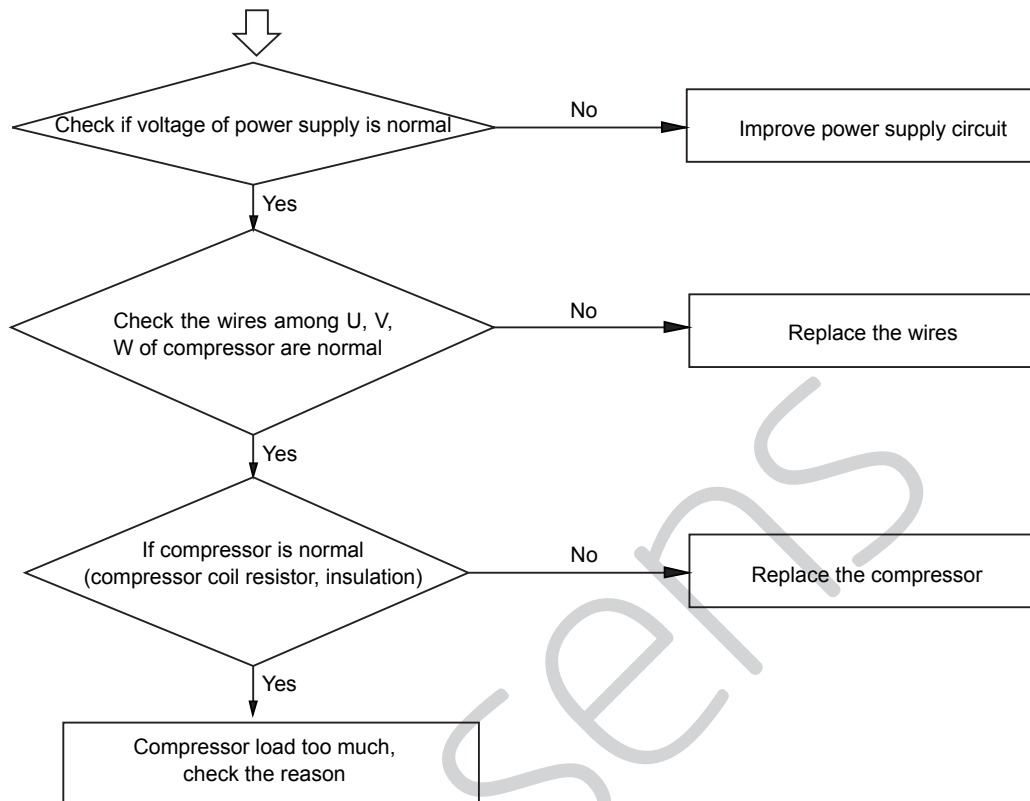

[81] IPM modular temp. too high protection [112] Radiator of transducer temp. too high

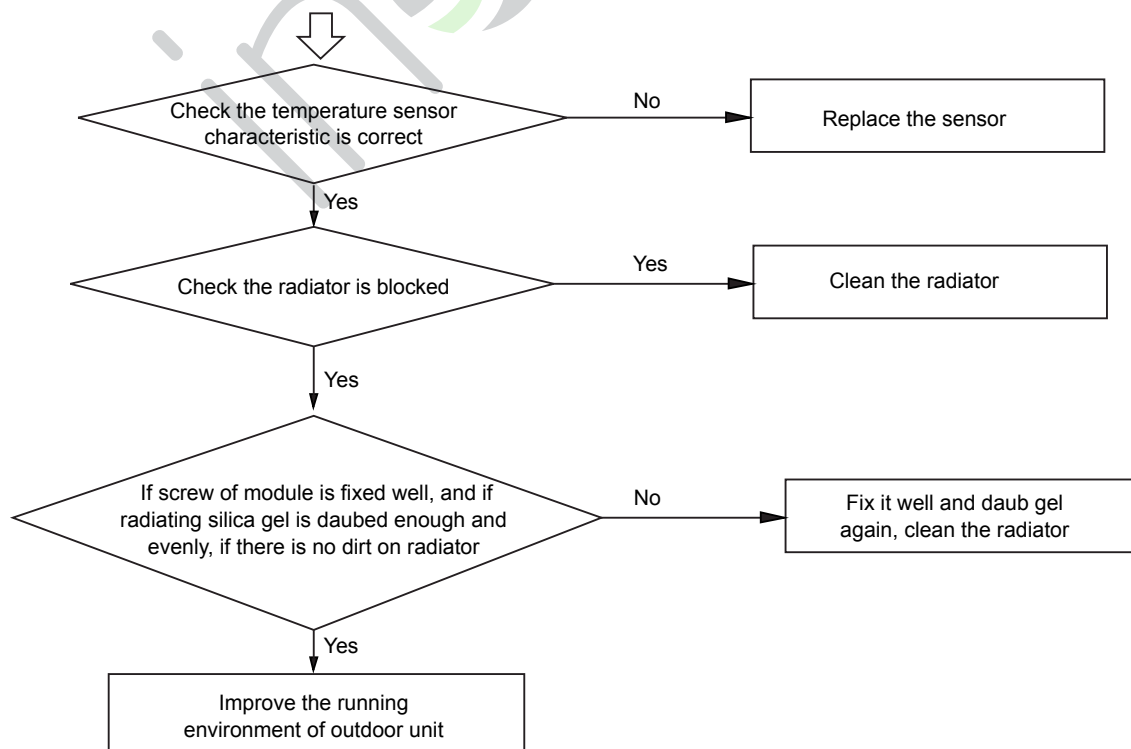

[113] Protection of overload

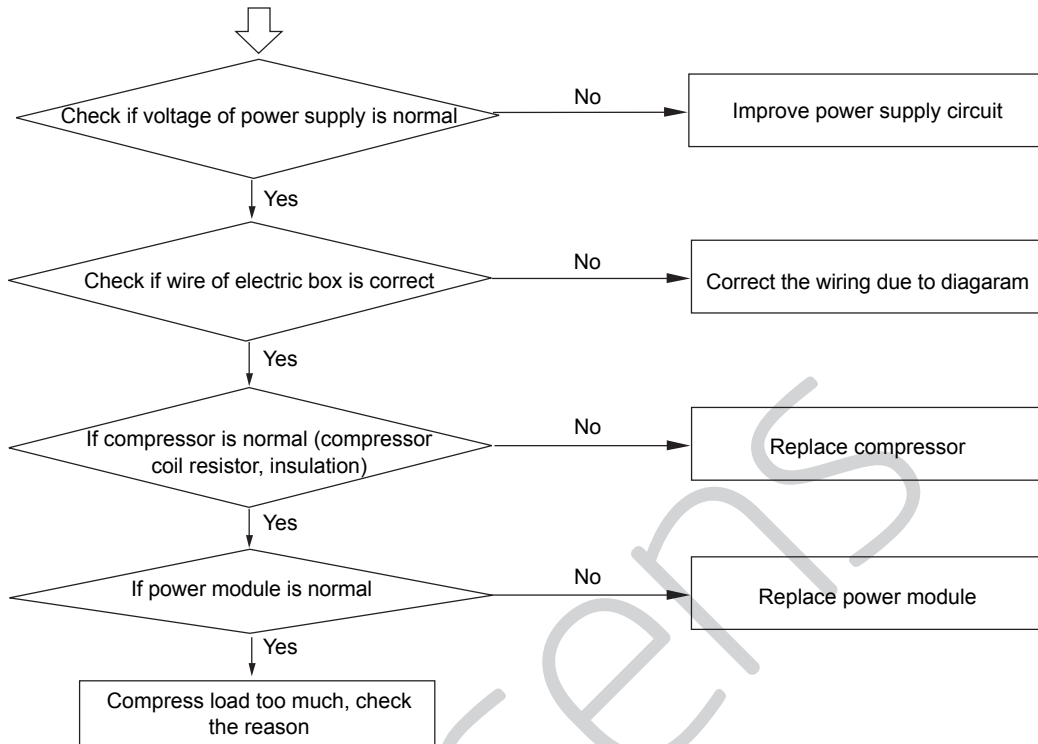

[114] Voltage too low of DC bus line of transducer

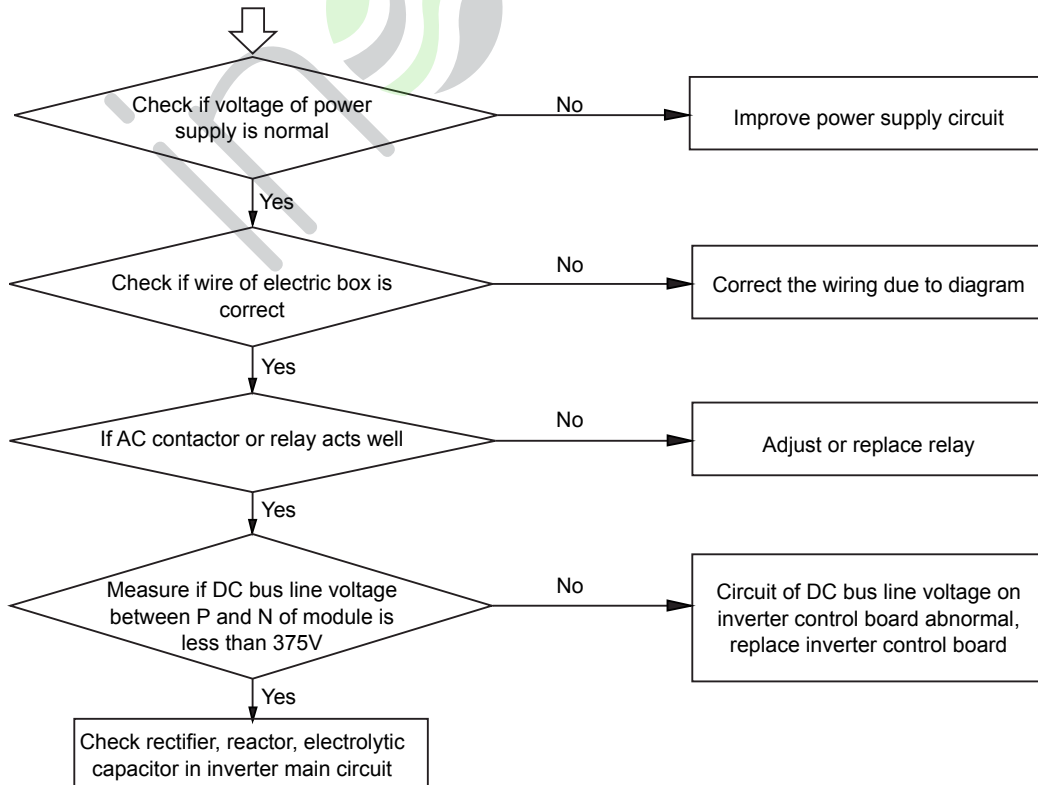

[115] Voltage too high of DC bus line of transducer

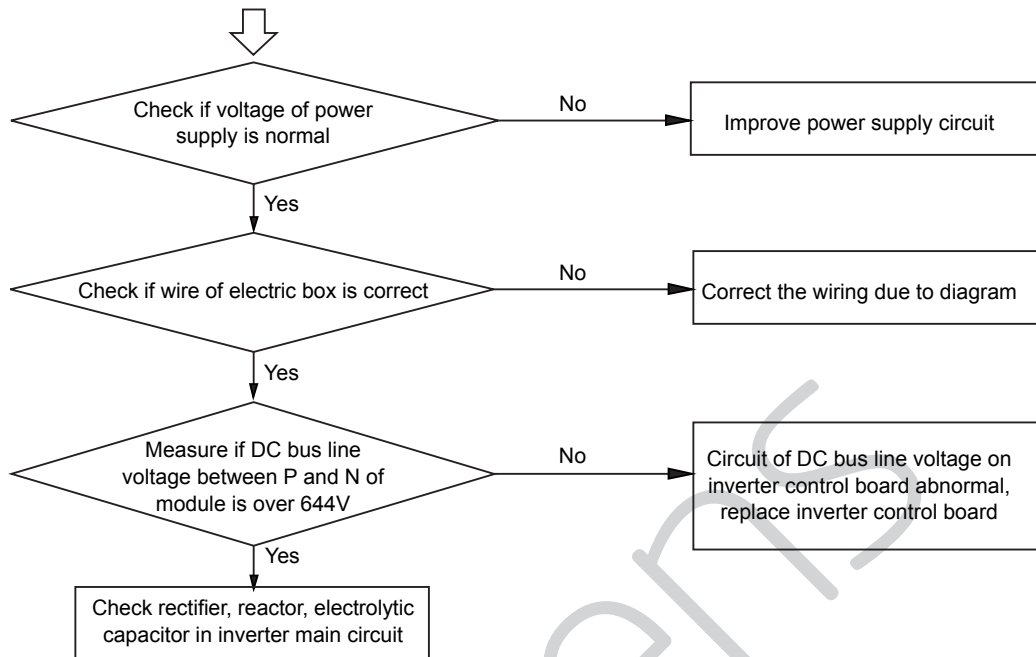

[116] Communication abnormal between transducer (inverter module board) and control PCB

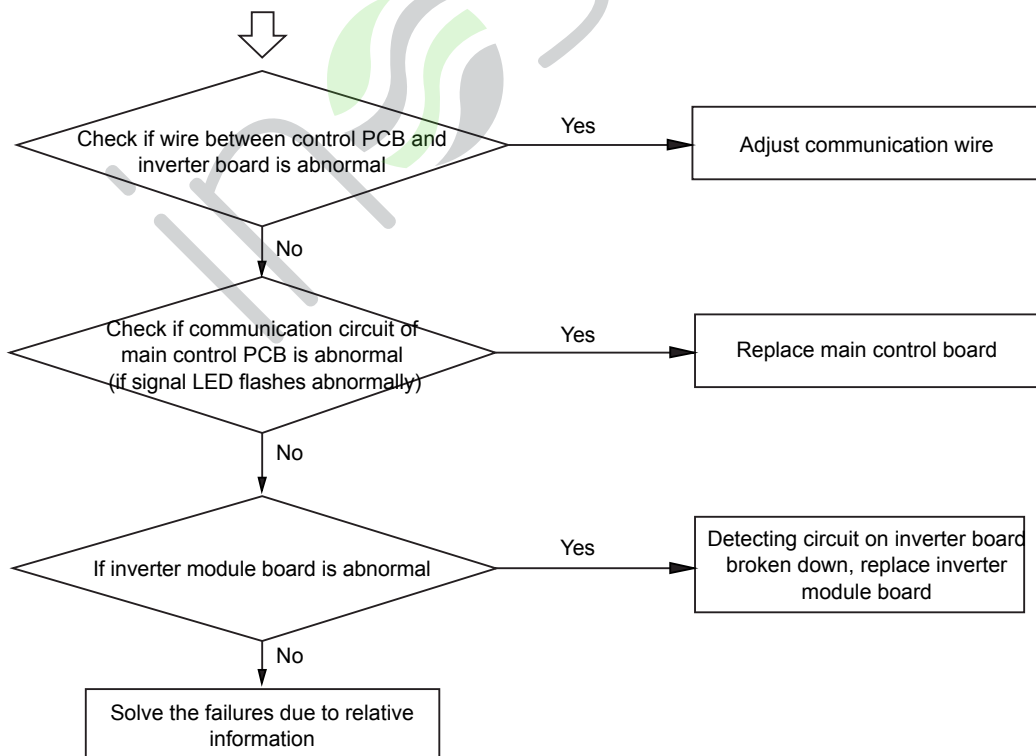

[117] Transducer over current (software protection)

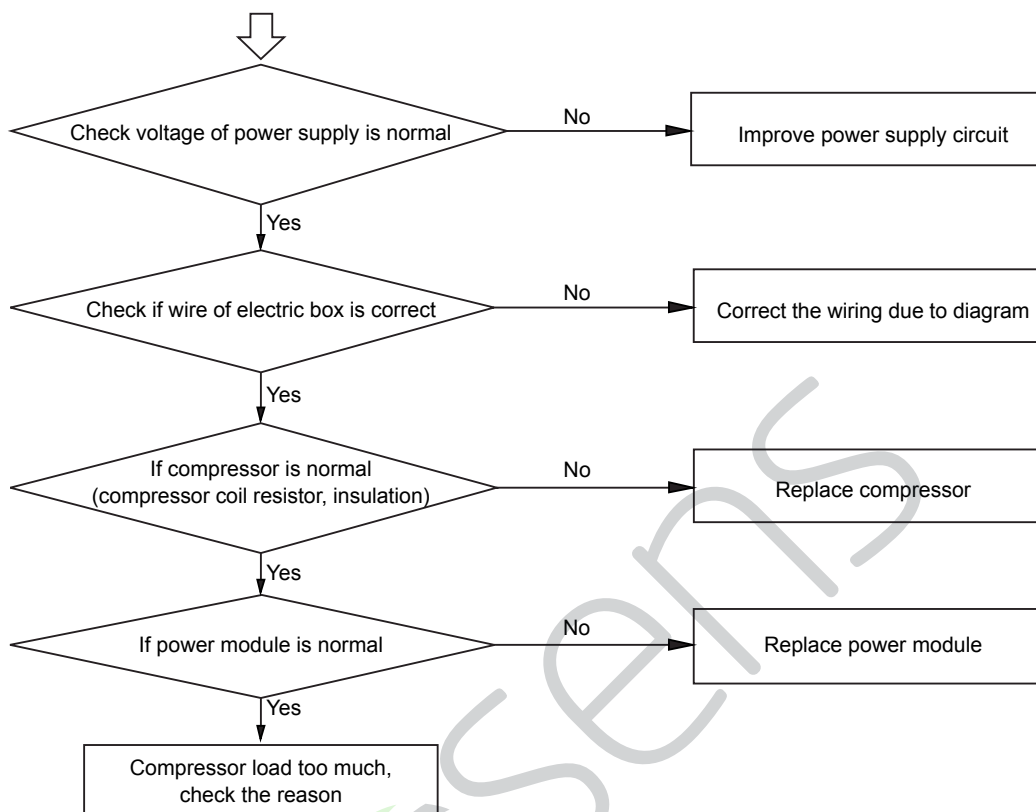

[118] Compressor startup failure

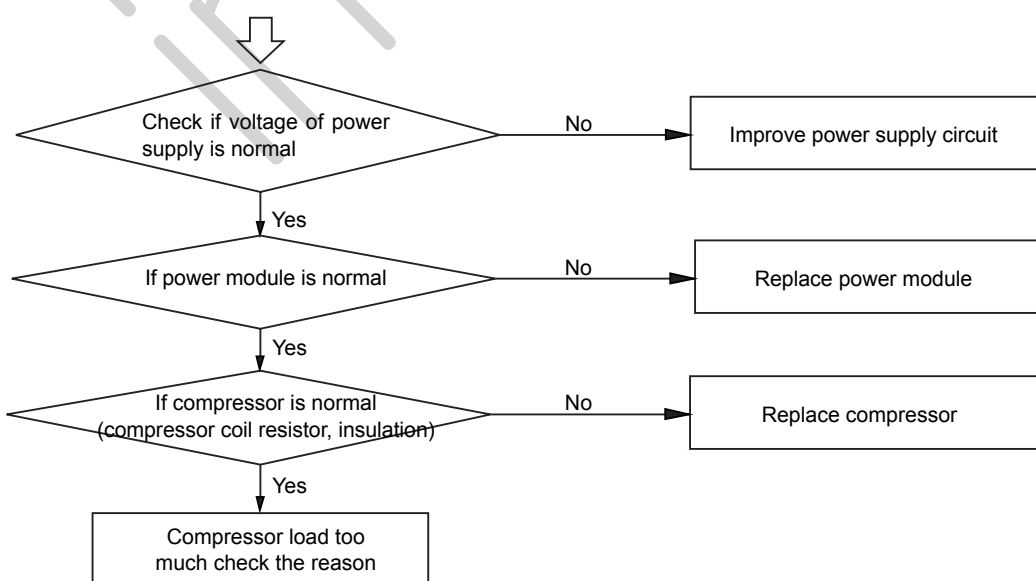

[119] Current detecting circuit abnormal of transducer

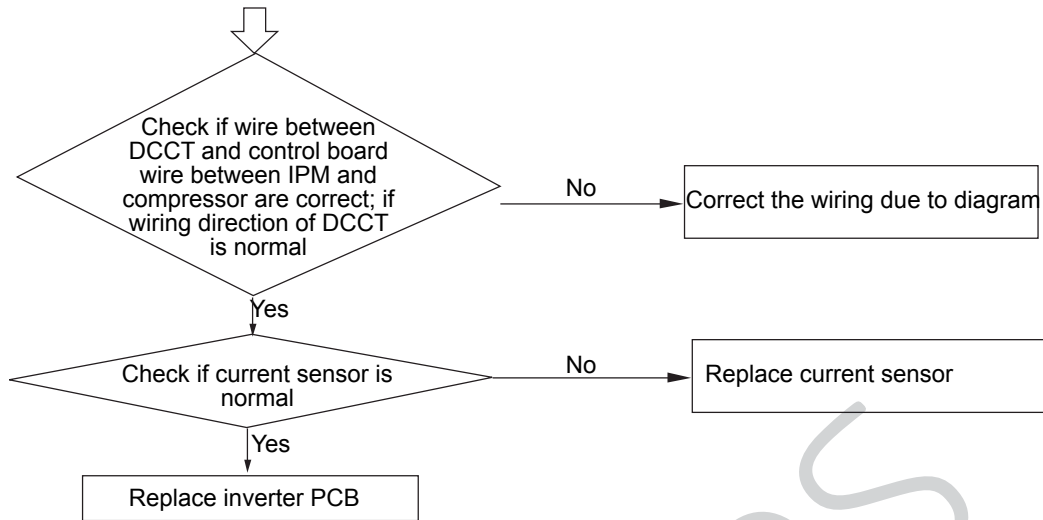

[122] Radiator temp. sensor of transducer abnormal

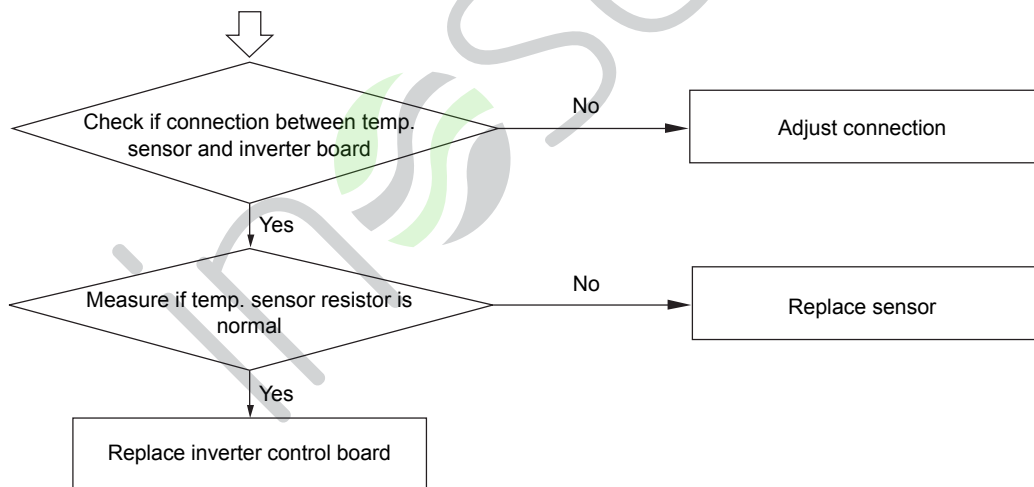

[120] Power supply of transducer abnormal

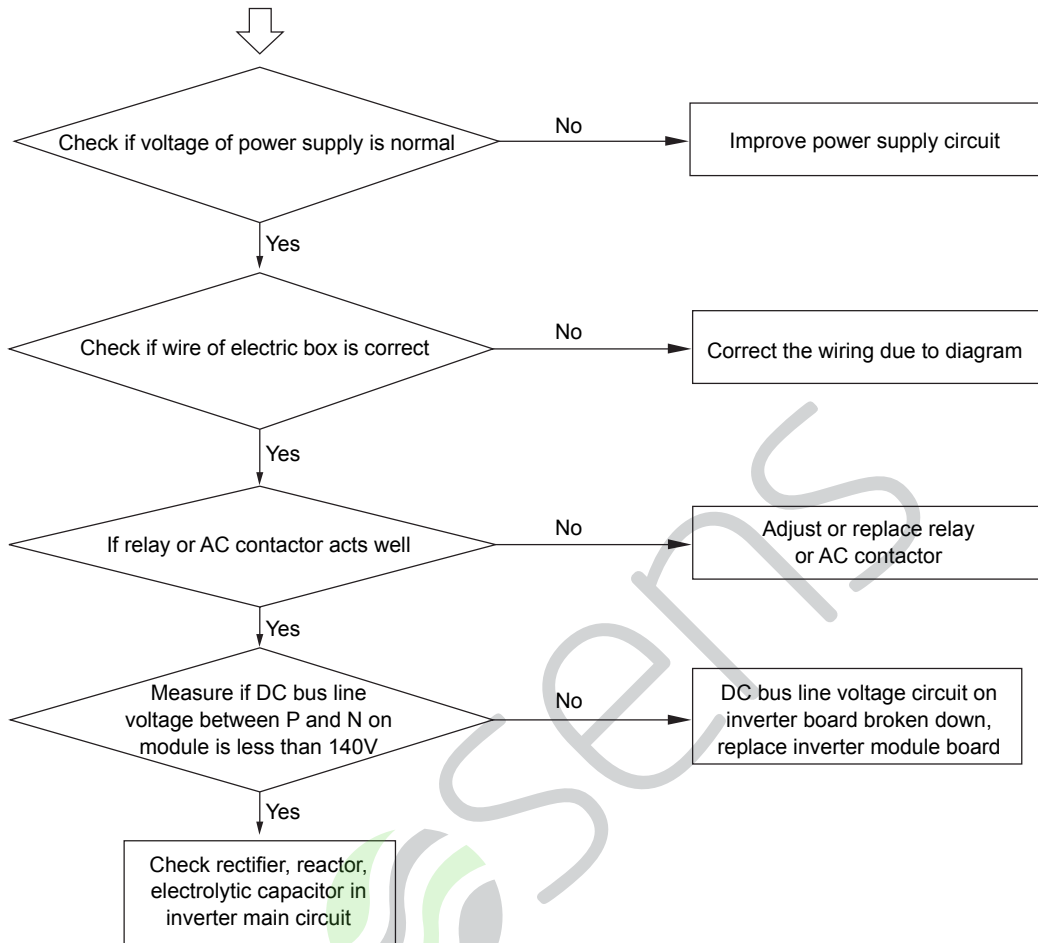

[121] Power supply of inverter board is abnormal

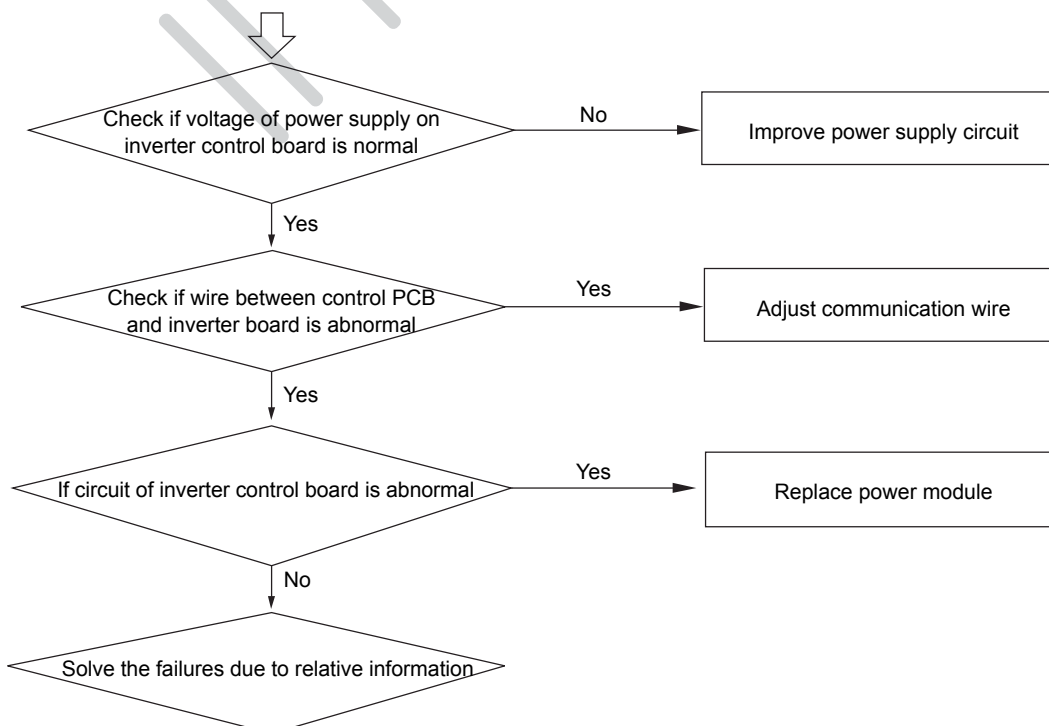

APPENDIX

Sensor characteristic

Temp. sensor characteristic

No.	Sensor type	Characteristic
1	Indoor coil/outdoor suction/oil temp./defrost/ambient temp. sensor	R (25°C)=10KΩ B (25°C/50°C)=3700K
2	Wired controller ambient temp./indoor ambient temp. sensor	R (25°C)=23KΩ B (25°C/50°C)=4200K
3	Outdoor discharging temp. sensor	R (80°C)=50KΩ B (25°C/80°C)=4450K

Herein, the sensor typical resistor is as follows:

(1) R (25°C)=10KΩ B (25°C/50°C)=3700K

R25=10KΩ±3% B25/50=3700K±3%					
Temp	Resistance (KΩ)			% (Resist. tol)	
(°C)	Rmax	R (t) Normal	Rmin	MAX (+)	MIN (-)
-30	145.82	135.02	124.22	7.00	7.00
-29	138.07	129.13	120.18	6.93	6.93
-28	131.79	123.34	114.89	6.85	6.85
-27	125.67	117.68	109.70	6.78	6.78
-26	119.71	112.18	104.65	6.71	6.71
-25	113.93	106.84	99.75	6.64	6.64
-24	108.36	101.69	95.01	6.56	6.56
-23	103.00	96.72	90.44	6.49	6.49
-22	97.85	91.95	86.05	6.42	6.42
-21	92.92	87.37	81.83	6.35	6.35
-20	88.20	82.99	77.79	6.27	6.27
-19	83.70	78.82	73.93	6.20	6.20
-18	79.42	74.83	70.25	6.13	6.13
-17	75.34	71.04	66.74	6.05	6.05
-16	71.47	67.44	63.40	5.98	5.98
-15	67.80	64.02	60.23	5.91	5.91
-14	64.32	60.77	57.22	5.84	5.84
-13	61.02	57.69	54.37	5.76	5.76
-12	57.90	54.78	51.66	5.69	5.69
-11	54.94	52.02	49.10	5.62	5.62
-10	52.15	49.41	46.67	5.55	5.55
-9	49.51	46.94	44.37	5.47	5.47
-8	47.02	44.61	42.20	5.40	5.40
-7	44.66	42.40	40.14	5.33	5.33
-6	42.43	40.32	38.20	5.25	5.25
-5	40.33	38.35	36.36	5.18	5.18
-4	38.35	36.48	34.62	5.11	5.11
-3	36.47	34.72	32.97	5.04	5.04
-2	34.70	33.06	31.42	4.96	4.96
-1	33.03	31.49	29.95	4.89	4.89
0	31.45	30.00	28.56	4.82	4.82
1	29.95	28.59	27.24	4.75	4.75
2	28.54	27.26	25.99	4.67	4.67
3	27.20	26.01	24.81	4.60	4.60
4	25.94	24.82	23.69	4.53	4.53
5	24.74	23.69	22.63	4.45	4.45
6	23.61	22.62	21.63	4.38	4.38

R25=10KΩ±3% B25/50=3700K±3%					
Temp	Resistance (KΩ)			% (Resist. tol)	
(°C)	Rmax	R (t) Normal	Rmin	MAX (+)	MIN (-)
7	22.54	21.61	20.68	4.31	4.31
8	21.52	20.65	19.77	4.24	4.24
9	20.56	19.74	18.92	4.16	4.16
10	19.65	18.87	18.10	4.09	4.09
11	18.78	18.05	17.33	4.02	4.02
12	17.96	17.28	16.59	3.95	3.95
13	17.18	16.54	15.90	3.87	3.87
14	16.44	15.83	15.23	3.80	3.80
15	15.73	15.17	14.60	3.73	3.73
16	15.06	14.53	14.00	3.65	3.65
17	14.42	13.93	13.43	3.58	3.58
18	13.82	13.35	12.88	3.51	3.51
19	13.24	12.80	12.36	3.44	3.44
20	12.69	12.28	11.86	3.36	3.36
21	12.17	11.78	11.39	3.29	3.29
22	11.67	11.30	10.94	3.22	3.22
23	11.19	10.85	10.51	3.15	3.15
24	10.73	10.41	10.09	3.07	3.07
25	10.30	10.00	9.70	3.00	3.00
26	9.90	9.60	9.31	3.06	3.06
27	9.51	9.23	8.94	3.13	3.13
28	9.15	8.86	8.58	3.19	3.19
29	8.80	8.52	8.24	3.25	3.25
30	8.46	8.19	7.92	3.31	3.31
31	8.14	7.87	7.61	3.38	3.38
32	7.83	7.57	7.31	3.44	3.44
33	7.53	7.28	7.02	3.50	3.50
34	7.25	7.00	6.75	3.56	3.56
35	6.98	6.73	6.49	3.63	3.63
36	6.72	6.48	6.24	3.69	3.69
37	6.47	6.23	6.00	3.75	3.75
38	6.23	6.00	5.77	3.81	3.81
39	6.00	5.77	5.55	3.88	3.88
40	5.78	5.56	5.34	3.94	3.94
41	5.56	5.35	5.14	4.00	4.00
42	5.36	5.15	4.94	4.06	4.06
43	5.17	4.96	4.76	4.13	4.13
44	4.98	4.78	4.58	4.19	4.19
45	4.80	4.60	4.41	4.25	4.25
46	4.63	4.43	4.24	4.31	4.31
47	4.46	4.27	4.09	4.38	4.38
48	4.30	4.12	3.94	4.44	4.44
49	4.15	3.97	3.79	4.50	4.50
50	4.00	3.83	3.65	4.56	4.56
51	3.86	3.69	3.52	4.63	4.63
52	3.72	3.56	3.39	4.69	4.69
53	3.59	3.43	3.27	4.75	4.75
54	3.47	3.31	3.15	4.81	4.81
55	3.35	3.19	3.04	4.88	4.88
56	3.23	3.08	2.93	4.94	4.94

R25=10KΩ±3% B25/50=3700K±3%					
Temp	Resistance (KΩ)			% (Resist. tol)	
(°C)	Rmax	R (t) Normal	Rmin	MAX (+)	MIN (-)
57	3.12	2.97	2.83	5.00	5.00
58	3.02	2.87	2.73	5.06	5.06
59	2.91	2.77	2.63	5.13	5.13
60	2.82	2.68	2.54	5.19	5.19
61	2.72	2.59	2.45	5.25	5.25
62	2.63	2.50	2.36	5.31	5.31
63	2.54	2.41	2.28	5.38	5.38
64	2.46	2.33	2.21	5.44	5.44
65	2.38	2.26	2.13	5.50	5.50
66	2.30	2.18	2.06	5.56	5.56
67	2.23	2.11	1.99	5.63	5.63
68	2.16	2.04	1.92	5.69	5.69
69	2.09	1.97	1.86	5.75	5.75
70	2.02	1.91	1.80	5.81	5.81
71	1.96	1.85	1.74	5.88	5.88
72	1.90	1.79	1.69	5.94	5.94
73	1.84	1.74	1.63	6.00	6.00
74	1.78	1.68	1.58	6.06	6.06
75	1.73	1.63	1.53	6.13	6.13
76	1.68	1.58	1.48	6.19	6.19
77	1.63	1.53	1.43	6.25	6.25
78	1.58	1.48	1.39	6.31	6.31
79	1.53	1.44	1.35	6.38	6.38
80	1.49	1.40	1.31	6.44	6.44
81	1.44	1.36	1.27	6.50	6.50
82	1.40	1.32	1.23	6.56	6.56
83	1.36	1.28	1.19	6.63	6.63
84	1.32	1.24	1.16	6.69	6.69
85	1.29	1.20	1.12	6.75	6.75
86	1.25	1.17	1.09	6.81	6.81
87	1.21	1.14	1.06	6.88	6.88
88	1.18	1.10	1.03	6.94	6.94
89	1.15	1.07	1.00	7.00	7.00
90	1.12	1.04	0.97	7.06	7.06
91	1.09	1.01	0.94	7.13	7.13
92	1.06	0.99	0.91	7.19	7.19
93	1.03	0.96	0.89	7.25	7.25
94	1.00	0.93	0.86	7.31	7.31
95	0.97	0.90	0.84	7.38	7.38
96	0.94	0.88	0.81	7.44	7.44
97	0.92	0.85	0.79	7.50	7.50
98	0.89	0.83	0.77	7.56	7.56
99	0.87	0.81	0.75	7.63	7.63
100	0.84	0.78	0.72	7.69	7.69
101	0.82	0.76	0.70	7.75	7.75
102	0.80	0.74	0.68	7.81	7.81
103	0.77	0.72	0.66	7.88	7.88
104	0.75	0.69	0.64	7.94	7.94
105	0.73	0.67	0.62	8.00	8.00

(2) R (25°C)=23KΩ B (25°C/50°C)=4200K

R25=23KΩ±3% B25/50=4200K±3%					
Temp	Resistance (KΩ)			% (Resist. tol)	
°C	Rmax	R (t) Normal	Rmin	MAX (+)	MIN (-)
-30	538.77	513.12	487.46	5.00	5.00
-29	502.58	478.89	455.21	4.95	4.95
-28	469.29	447.41	425.53	4.89	4.89
-27	438.61	418.38	398.15	4.84	4.84
-26	410.29	391.56	372.84	4.78	4.78
-25	384.09	366.75	349.41	4.73	4.73
-24	359.82	343.75	327.69	4.67	4.67
-23	337.30	322.41	307.52	4.62	4.62
-22	316.38	302.57	288.76	4.56	4.56
-21	296.92	284.11	271.29	4.51	4.51
-20	278.79	266.91	255.02	4.45	4.45
-19	261.90	250.87	239.83	4.40	4.40
-18	246.15	235.90	225.64	4.35	4.35
-17	231.43	221.91	212.39	4.29	4.29
-16	217.69	208.84	199.99	4.24	4.24
-15	204.83	196.61	188.39	4.18	4.18
-14	192.81	185.16	177.52	4.13	4.13
-13	181.55	174.44	167.34	4.07	4.07
-12	171.01	164.40	157.79	4.02	4.02
-11	161.13	154.98	148.84	3.96	3.96
-10	151.87	146.15	140.44	3.91	3.91
-9	143.18	137.87	132.56	3.85	3.85
-8	135.04	130.10	125.15	3.80	3.80
-7	127.40	122.80	118.20	3.75	3.75
-6	120.23	115.95	111.67	3.69	3.69
-5	113.49	109.51	105.53	3.64	3.64
-4	107.17	103.46	99.76	3.58	3.58
-3	101.23	97.78	94.33	3.53	3.53
-2	95.65	92.44	89.23	3.47	3.47
-1	90.40	87.42	84.43	3.42	3.42
0	85.47	82.69	79.91	3.36	3.36
1	80.84	78.25	75.66	3.31	3.31
2	76.48	74.07	71.66	3.25	3.25
3	72.38	70.13	67.89	3.20	3.20
4	68.52	66.43	64.34	3.15	3.15
5	64.89	62.94	61.00	3.09	3.09
6	61.47	59.66	57.85	3.04	3.04
7	58.25	56.57	54.88	2.98	2.98
8	55.22	53.65	52.08	2.93	2.93
9	52.37	50.90	49.44	2.87	2.87
10	49.68	48.31	46.95	2.82	2.82
11	47.14	45.87	44.60	2.76	2.76
12	44.75	43.57	42.39	2.71	2.71
13	42.49	41.40	40.30	2.65	2.65
14	40.37	39.34	38.32	2.60	2.60
15	38.36	37.41	36.45	2.55	2.55
16	36.46	35.58	34.69	2.49	2.49
17	34.67	33.85	33.02	2.44	2.44

R25=23K Ω \pm 3% B25/50=4200K \pm 3%					
Temp	Resistance (K Ω)			% (Resist. tol)	
$^{\circ}$ C	Rmax	R (t) Normal	Rmin	MAX (+)	MIN (-)
18	32.98	32.22	31.45	2.38	2.38
19	31.39	30.67	29.96	2.33	2.33
20	29.87	29.21	28.55	2.27	2.27
21	28.45	27.83	27.21	2.22	2.22
22	27.10	26.52	25.95	2.16	2.16
23	25.82	25.28	24.75	2.11	2.11
24	24.61	24.11	23.62	2.05	2.05
25	23.46	23.00	22.54	2.00	2.00
26	22.40	21.95	21.50	2.04	2.04
27	21.39	20.95	20.51	2.09	2.09
28	20.43	20.00	19.58	2.13	2.13
29	19.52	19.10	18.69	2.18	2.18
30	18.66	18.25	17.85	2.22	2.22
31	17.84	17.44	17.05	2.26	2.26
32	17.06	16.67	16.29	2.31	2.31
33	16.32	15.94	15.57	2.35	2.35
34	15.61	15.25	14.88	2.39	2.39
35	14.94	14.59	14.23	2.44	2.44
36	14.31	13.96	13.61	2.48	2.48
37	13.70	13.36	13.03	2.53	2.53
38	13.12	12.79	12.47	2.57	2.57
39	12.57	12.25	11.93	2.61	2.61
40	12.05	11.74	11.42	2.66	2.66
41	11.55	11.24	10.94	2.70	2.70
42	11.07	10.78	10.48	2.74	2.74
43	10.62	10.33	10.04	2.79	2.79
44	10.18	9.90	9.62	2.83	2.83
45	9.77	9.50	9.22	2.88	2.88
46	9.38	9.11	8.84	2.92	2.92
47	9.00	8.74	8.48	2.96	2.96
48	8.64	8.39	8.14	3.01	3.01
49	8.30	8.05	7.80	3.05	3.05
50	7.97	7.73	7.49	3.09	3.09
51	7.65	7.42	7.19	3.14	3.14
52	7.35	7.13	6.90	3.18	3.18
53	7.07	6.85	6.63	3.23	3.23
54	6.79	6.58	6.36	3.27	3.27
55	6.53	6.32	6.11	3.31	3.31
56	6.28	6.08	5.87	3.36	3.36
57	6.04	5.84	5.64	3.40	3.40
58	5.81	5.62	5.43	3.44	3.44
59	5.59	5.40	5.22	3.49	3.49
60	5.38	5.20	5.02	3.53	3.53
61	5.18	5.00	4.82	3.58	3.58
62	4.99	4.82	4.64	3.62	3.62
63	4.81	4.64	4.47	3.66	3.66
64	4.63	4.46	4.30	3.71	3.71
65	4.46	4.30	4.14	3.75	3.75
66	4.30	4.14	3.99	3.79	3.79

R25=23KΩ±3% B25/50=4200K±3%					
Temp	Resistance (KΩ)			% (Resist. tol)	
°C	Rmax	R (t) Normal	Rmin	MAX (+)	MIN (-)
67	4.15	3.99	3.84	3.84	3.84
68	4.00	3.85	3.70	3.88	3.88
69	3.86	3.71	3.56	3.93	3.93
70	3.72	3.58	3.44	3.97	3.97
71	3.59	3.45	3.31	4.01	4.01
72	3.47	3.33	3.20	4.06	4.06
73	3.35	3.22	3.08	4.10	4.10
74	3.23	3.10	2.98	4.14	4.14
75	3.12	3.00	2.87	4.19	4.19
76	3.02	2.90	2.77	4.23	4.23
77	2.92	2.80	2.68	4.28	4.28
78	2.82	2.70	2.59	4.32	4.32
79	2.73	2.61	2.50	4.36	4.36
80	2.64	2.53	2.42	4.41	4.41
81	2.56	2.45	2.34	4.45	4.45
82	2.47	2.37	2.26	4.49	4.49
83	2.39	2.29	2.19	4.54	4.54
84	2.32	2.22	2.12	4.58	4.58
85	2.25	2.15	2.05	4.63	4.63
86	2.18	2.08	1.98	4.67	4.67
87	2.11	2.02	1.92	4.71	4.71
88	2.05	1.95	1.86	4.76	4.76
89	1.98	1.89	1.80	4.80	4.80
90	1.92	1.83	1.75	4.84	4.84
91	1.87	1.78	1.69	4.89	4.89
92	1.81	1.72	1.64	4.93	4.93
93	1.76	1.67	1.59	4.98	4.98
94	1.70	1.62	1.54	5.02	5.02
95	1.65	1.57	1.49	5.06	5.06
96	1.60	1.52	1.45	5.11	5.11
97	1.55	1.48	1.40	5.15	5.15
98	1.51	1.43	1.36	5.19	5.19
99	1.46	1.39	1.32	5.24	5.24
100	1.42	1.35	1.28	5.28	5.28
101	1.37	1.31	1.24	5.33	5.33
102	1.33	1.26	1.20	5.37	5.37
103	1.29	1.22	1.16	5.41	5.41
104	1.25	1.18	1.12	5.46	5.46
105	1.21	1.15	1.08	5.50	5.50

(3) R (80°C)=50KΩ B (25°C/80°C)=4450K

R80=50KΩ±3% B25/80=4450K±3%					
Temp	Resistance (KΩ)			% (Resist.tol)	
°C	Rmax	R (t) Normal	Rmin	MAX (+)	MIN (-)
0	1749.01	1921.99	2094.97	9.00	9.00
1	1651.43	1813.27	1975.10	8.93	8.93
2	1560.17	1711.65	1863.13	8.85	8.85
3	1474.74	1616.59	1758.45	8.78	8.78
4	1394.71	1527.61	1660.51	8.70	8.70
5	1319.68	1444.25	1568.82	8.63	8.63
6	1249.30	1366.10	1482.90	8.55	8.55
7	1183.21	1292.77	1402.34	8.48	8.48
8	1121.12	1223.94	1326.75	8.40	8.40
9	1062.76	1159.27	1255.77	8.33	8.33
10	1007.85	1098.47	1189.10	8.25	8.25
11	956.17	1041.29	1126.42	8.18	8.18
12	907.49	987.48	1067.46	8.10	8.10
13	861.62	936.80	1011.98	8.03	8.03
14	818.37	889.05	959.73	7.95	7.95
15	777.57	844.04	910.51	7.88	7.88
16	739.07	801.59	864.11	7.80	7.80
17	702.71	761.53	820.36	7.73	7.73
18	668.35	723.72	779.08	7.65	7.65
19	635.89	688.00	740.12	7.58	7.58
20	605.19	654.25	703.32	7.50	7.50
21	576.15	622.36	668.57	7.43	7.43
22	548.66	592.19	635.72	7.35	7.35
23	522.65	563.65	604.66	7.28	7.28
24	498.01	536.64	575.28	7.20	7.20
25	474.66	511.08	547.49	7.13	7.13
26	452.54	486.86	521.19	7.05	7.05
27	431.56	463.92	496.28	6.98	6.98
28	411.67	442.18	472.69	6.90	6.90
29	392.80	421.57	450.34	6.83	6.83
30	374.89	402.03	429.17	6.75	6.75
31	357.89	383.49	409.09	6.68	6.68
32	341.75	365.90	390.05	6.60	6.60
33	326.42	349.20	371.99	6.53	6.53
34	311.85	333.35	354.85	6.45	6.45
35	298.00	318.30	338.59	6.38	6.38
36	284.84	304.00	323.15	6.30	6.30
37	272.33	290.41	308.49	6.23	6.23
38	260.43	277.49	294.56	6.15	6.15
39	249.10	265.22	281.33	6.08	6.08
40	238.33	253.54	268.75	6.00	6.00
41	228.07	242.44	256.80	5.93	5.93
42	218.31	231.87	245.44	5.85	5.85
43	209.01	221.82	234.63	5.78	5.78
44	200.15	212.25	224.35	5.70	5.70
45	191.72	203.14	214.57	5.63	5.63
46	183.67	194.47	205.26	5.55	5.55
47	176.01	186.20	196.40	5.48	5.48

R80=50KΩ±3% B25/80=4450K±3%					
Temp	Resistance (KΩ)			% (Resist.tol)	
°C	Rmax	R (t) Normal	Rmin	MAX (+)	MIN (-)
48	168.70	178.33	187.96	5.40	5.40
49	161.74	170.83	179.93	5.33	5.33
50	155.09	163.68	172.28	5.25	5.25
51	148.75	156.87	164.98	5.18	5.18
52	142.70	150.37	158.04	5.10	5.10
53	136.92	144.17	151.41	5.03	5.03
54	131.41	138.26	145.10	4.95	4.95
55	126.15	132.61	139.08	4.88	4.88
56	121.12	127.23	133.34	4.80	4.80
57	116.32	122.09	127.86	4.73	4.73
58	111.73	117.18	122.63	4.65	4.65
59	107.35	112.49	117.64	4.58	4.58
60	103.16	108.02	112.88	4.50	4.50
61	99.15	103.74	108.33	4.43	4.43
62	95.32	99.65	103.99	4.35	4.35
63	91.66	95.75	99.84	4.28	4.28
64	88.15	92.01	95.88	4.20	4.20
65	84.80	88.44	92.09	4.13	4.13
66	81.58	85.03	88.47	4.05	4.05
67	78.51	81.76	85.01	3.98	3.98
68	75.57	78.64	81.70	3.90	3.90
69	72.75	75.65	78.54	3.83	3.83
70	70.05	72.78	75.51	3.75	3.75
71	67.47	70.04	72.61	3.68	3.68
72	64.99	67.42	69.84	3.60	3.60
73	62.61	64.90	67.19	3.53	3.53
74	60.34	62.49	64.65	3.45	3.45
75	58.15	60.19	62.22	3.38	3.38
76	56.06	57.97	59.89	3.30	3.30
77	54.05	55.85	57.65	3.23	3.23
78	52.13	53.82	55.52	3.15	3.15
79	50.28	51.87	53.47	3.08	3.08
80	48.50	50.00	51.50	3.00	3.00
81	46.73	48.21	49.68	3.07	3.07
82	45.03	46.48	47.94	3.13	3.13
83	43.40	44.83	46.27	3.20	3.20
84	41.83	43.25	44.66	3.27	3.27
85	40.33	41.72	43.11	3.33	3.33
86	38.89	40.26	41.63	3.40	3.40
87	37.51	38.86	40.20	3.47	3.47
88	36.18	37.51	38.83	3.53	3.53
89	34.91	36.21	37.51	3.60	3.60
90	33.68	34.96	36.24	3.67	3.67
91	32.50	33.76	35.03	3.73	3.73
92	31.37	32.61	33.85	3.80	3.80
93	30.29	31.50	32.72	3.87	3.87
94	29.24	30.44	31.64	3.93	3.93
95	28.24	29.41	30.59	4.00	4.00
96	27.27	28.43	29.58	4.07	4.07

R80=50KΩ±3% B25/80=4450K±3%					
Temp	Resistance (KΩ)			% (Resist.tol)	
°C	Rmax	R (t) Normal	Rmin	MAX (+)	MIN (-)
97	26.34	27.48	28.61	4.13	4.13
98	25.45	26.56	27.68	4.20	4.20
99	24.59	25.69	26.78	4.27	4.27
100	23.76	24.84	25.91	4.33	4.33
101	22.97	24.02	25.08	4.40	4.40
102	22.20	23.24	24.28	4.47	4.47
103	21.46	22.48	23.50	4.53	4.53
104	20.75	21.75	22.75	4.60	4.60
105	20.07	21.05	22.03	4.67	4.67
106	19.41	20.37	21.34	4.73	4.73
107	18.77	19.72	20.67	4.80	4.80
108	18.16	19.09	20.02	4.87	4.87
109	17.57	18.49	19.40	4.93	4.93
110	17.01	17.90	18.80	5.00	5.00
111	16.46	17.34	18.22	5.07	5.07
112	15.93	16.79	17.66	5.13	5.13
113	15.42	16.27	17.11	5.20	5.20
114	14.93	15.76	16.59	5.27	5.27
115	14.46	15.28	16.09	5.33	5.33
116	14.01	14.80	15.60	5.40	5.40
117	13.57	14.35	15.13	5.47	5.47
118	13.14	13.91	14.68	5.53	5.53
119	12.73	13.49	14.24	5.60	5.60
120	12.34	13.08	13.82	5.67	5.67
121	11.96	12.69	13.41	5.73	5.73
122	11.59	12.31	13.02	5.80	5.80
123	11.24	11.94	12.64	5.87	5.87
124	10.90	11.58	12.27	5.93	5.93
125	10.57	11.24	11.92	6.00	6.00
126	10.25	10.91	11.57	6.07	6.07
127	9.94	10.59	11.24	6.13	6.13
128	9.65	10.29	10.92	6.20	6.20
129	9.36	9.99	10.61	6.27	6.27
130	9.09	9.70	10.32	6.33	6.33
131	8.82	9.43	10.03	6.40	6.40
132	8.57	9.16	9.75	6.47	6.47
133	8.32	8.90	9.48	6.53	6.53
134	8.08	8.65	9.22	6.60	6.60
135	7.85	8.41	8.97	6.67	6.67
136	7.63	8.18	8.73	6.73	6.73
137	7.42	7.96	8.50	6.80	6.80
138	7.21	7.74	8.27	6.87	6.87
139	7.01	7.53	8.06	6.93	6.93
140	6.82	7.33	7.85	7.00	7.00

Enthalpy-humidity chart

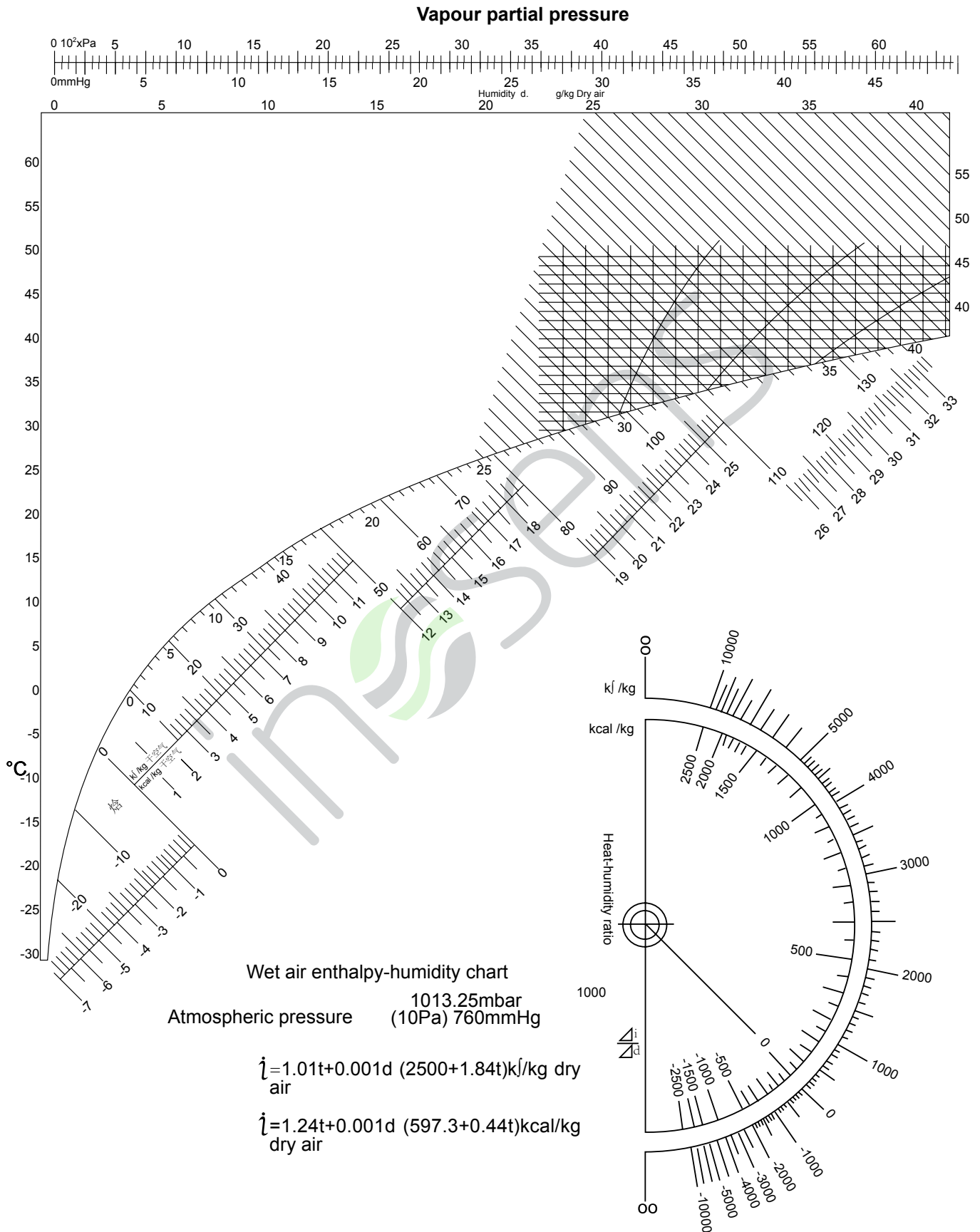



Haier Commercial Air Condition

ADDRESS: No.1 Haier Road, Hi-tech Zone, Qingdao 266101 P.R.China

Web: [Http://www.haier.com](http://www.haier.com)