

### MULTI-SPLIT AIR CONDITIONER INSTALLATION MANUAL

Original Instructions

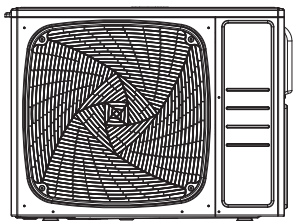

3U55S2SR2FA  
3U70S2SR2FA  
4U75S2SR2FA  
4U85S2SR2FA

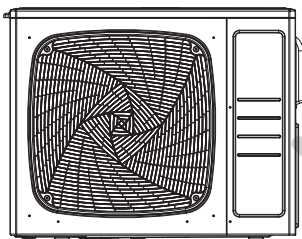

5U105S2SS2FA

### Contents

Safety Precautions .....	3
Move and scrap the air conditioning .....	15
Read Before Installation .....	16
Accessories .....	18
Procedure for Selecting the Location .....	18
Installation drawings of indoor and outdoor units .....	20
Precautions on Installation .....	21
Outdoor Unit Installation Guideline .....	21
Limitations on the installation .....	21
Refrigerant piping work .....	22
Pump Down Operation .....	26
Wiring work .....	26
Test running .....	28
Trouble shooting .....	29

English

No. 0150526390 A

- This product must only be installed or serviced by qualified personnel.  
Please read this manual carefully before installation. This appliance is filled with R32.  
Keep this manual for future reference.  
Original instructions



inSens

## EUROPEAN REGULATIONS CONFORMITY FOR THE MODELS

### CE

All the products are in conformity with the following European provision:

- Low voltage Directive
- Electromagnetic Compatibility

### ROHS

The products are fulfilled with the requirements in the directive 2011/65/EU of the European parliament and of council on the Restriction of the use of Certain Hazardous Substances in Electrical and Electronic Equipment(EU RoHS Directive)

### WEEE

In accordance with the directive 2012/19/EU of the European parliament,herewith we inform the consumer about the disposal requirements of the electrical and electronic products.

### DISPOSAL REQUIREMENTS:



Your air conditioning product is marked with this symbol.This means that electrical and electronic products shall not be mixed with unsorted household waste.Do not try to dismantle the system yourself:the dismantling of the air

conditioning system,treatment of the refrigerant,of oil and of other part must be done by a qualified installer in accordance with relevant local and national legislation.Air conditioners must be treated at a specialized treatment facility for reuse, recycling and recovery.By ensuring this product is disposed of correctly,you will help to prevent potential negative consequences for the environment and human health.Please contact the installer or local authority for more information. Battery must be removed from the remote controller and disposed of separately in accordance with relevant local and national legislation.

## ⚠ WARNING

If the supply cord is damaged, it must be replaced by the manufacturer, its service agent or similarly qualified persons in order to avoid a hazard.

This appliance is not intended for use by persons (including children) with reduced physical, sensory or mental capabilities, or lack of experience and knowledge, unless they have been given supervision or instruction concerning use of the appliance by a person responsible for their safety.

Children should be supervised to ensure that they do not play with the appliance.

This appliance can be used by children aged from 8 years and above and persons with reduced physical, sensory or mental capabilities or lack of experience and knowledge if they have been given supervision or instruction concerning use of the appliance in a safe way and understand the hazards involved.

Children shall not play with the appliance. Cleaning and user maintenance shall not be made by children without supervision.

The appliances are not intended to be operated by means of an external timer or separate remote-control system.

Keep the appliance and its cord out of reach of children less than 8 years.

The A-weighted sound pressure level is below 70 dB.

This appliance is intended to be used by expert or trained users in shops, in light industry and on farms, or for commercial use by lay persons.

Disconnect the appliance from its power source during maintenance service and when replacing parts. Air conditioner working temperature: cooling -10~46 degree, heating -15~24 degree.

The single indoor unit will reduce in heating efficiency if the ambient temperature is under 0 degree.

## IMPORTANT INFORMATION REGARDING THE REFRIGERANT USED

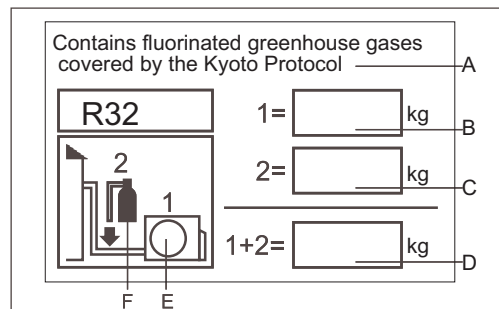

This product contains fluorinated greenhouse gases covered by the Kyoto Protocol.Do not vent into the atmosphere.

Refrigerant type:R32

GWP\*value:675

GWP=global warming potential

Please fill in with indelible ink,

- 1 the factory refrigerant charge of the product
- 2 the additional refrigerant amount charged in the field and
- 1+2 the total refrigerant charge

on the refrigerant charge label supplied with the product. The filled out label must be adhered in the proximity of the product charging port(e.g.onto the inside of the stop valve cover).

A contains fluorinated greenhouse gases covered by the Kyoto Protocol



B factory refrigerant charge of the product:see unit name plate

C additional refrigerant amount charged in the field

D total refrigerant charge

E outdoor unit

F refrigerant cylinder and manifold for charging

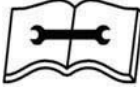
	Read the precautions in this manual carefully before operating the unit.		This appliance is filled with R32.
	Read the operator's manual		Service indicator, read technical manual

After reading this handbook, hand it over to those who will be using the unit.

The user of the unit should keep this manual at hand and make it available to those who will be performing repairs or relocating the unit. Also, make it available to the new user when the user changes hands.

## **⚠ WARNING**

Ask your dealer or qualified personnel to carry out installation work. Do not attempt to install the air conditioner yourself. Improper installation may result in water leakage, electric shocks, fire or explosion. All the cables shall have got the European authentication certificate. During installation, when the connecting cables break off, it must be assured that the grounding wire is the last one to be broken off.

If refrigerant gas leaks during installation, ventilate the area immediately. Toxic gas may be produced. If the refrigerant comes into contact with fire, and explosion may happen.

Make sure ground connection is correct and reliable. Do not earth the unit to a utility pipe, lightning conductor or telephone earth lead. Imperfect earthing may result in electric shocks.

The breaker of the air conditioner should be all-pole switch and explosion-proof. The distance between its two contacts should not be no less than 3mm. Such means for disconnection must be incorporated in the wiring.

The air conditioning sockets should be placed 1m above from the air conditioner, nor under the air conditioner. Be sure not to use open flame, high static electrical or high temperature equipments etc. nearby the air conditioner.

Do not use means to accelerate the defrosting process or to clean, other than those recommended by the manufacturer.

The appliance must be stored in a room without continuously operating ignition sources, the radius of the storage area should be no less than 2.5 m (for example: open flames, an operating gas appliance or an operating electric heater).

Do not pierce or burn.

Be aware that refrigerants may not contain an odour.

The appliance must be installed, operated and stored in a room with a floor area larger than the Minimum Room Area specified in the table on the following pages, The room should be well ventilated.

Comply with national gas regulations.

This appliance can be used by children aged 8 years and above and persons with reduced physical, sensory or mental capabilities or lack of experience and knowledge if they have been given supervision or instruction concerning use of the appliance in a safe way and understand the hazards involved. Children shall not play with the appliance. Cleaning and user maintenance shall not be made by children without supervision.

The air conditioner can not be discarded or scrapped Randomly If you need please contact customer service personnel of Haier to scrap in order to obtain the correct disposal methods.

Reusable mechanical connectors and flared joints are not allowed indoor.

## **⚠ CAUTION:**

Do not install the air conditioner at any place where there is danger of flammable gas leakage. In the event of a gas leakage, build-up of gas near the air conditioner may cause a fire to break out.

Tighten the flare nut according to the specified method such as with a torque wrench. If the flare nut is too tight, it may crack after prolonged use, causing refrigerant leakage.

Take adequate steps to prevent the outdoor unit being used as a shelter by small animals. Small animals making contact with electrical parts can cause malfunctions, smoke or fire.

Please instruct the customer to keep the area around the unit clean

The temperature of refrigerant circuit will be high, please keep the inter-unit wire away from copper pipes that not thermally insulated.

Only qualified personnel can handle, fill, purge and dispose of the refrigerant.

# Safety Precautions

## WARNING

- The installation, maintenance, service and repair operations of this product shall be carried out by professional personnel, who have been trained and certified by national training organizations that are accredited to teach the relevant national competency standards that may be set in legislation.  
Improper installation may cause water leakage, electrical shock, fire, or explosion.
- Install the air conditioner according to the instructions given in this manual.  
Incomplete installation may cause water leakage, electrical shock, fire, or explosion.
- Be sure to use the supplied or specified installation parts.  
Use of other parts may cause the unit to come loose, water leakage, electrical shock, fire, or explosion.
- Install the air conditioner on a solid base that can support the unit's weight.  
An inadequate base or incomplete installation may cause injury in the event the unit falls off the base.
- Electrical work should be carried out in accordance with the installation manual and the national electrical wiring rules or code of practice.  
Insufficient capacity or incomplete electrical work may cause electrical shock, fire, or explosion.
- Be sure to use a dedicated power circuit. Never use a power supply shared by another appliance.
- For wiring, use a cable long enough to cover the entire distance with no connection. Do not use an extension cord. Do not put other loads on the power supply, use a dedicated power circuit.  
(Failure to do so may cause abnormal heat, electrical shock, fire, or explosion.)
- Use the specified types of wires for electrical connections between the indoor and outdoor units.  
Firmly clamp the interconnecting wires so their terminals receive no external stresses. Incomplete connections or clamping may cause terminal overheating, fire, or explosion.
- After connecting interconnecting and supply wiring be sure to shape the cables so that they do not put undue force on the electrical covers or panels.  
Install covers over the wires. Incomplete cover installation may cause terminal overheating, electrical shock, fire, or explosion.
- If any refrigerant has leaked out during the installation work, ventilate the room.  
(The refrigerant produces a toxic gas if exposed to flames, may cause explosion.)
- After all installation is complete, check to make sure that no refrigerant is leaking out.  
(The refrigerant produces a toxic gas if exposed to flames, may cause explosion.)
- When installing or relocating the system, be sure to keep the refrigerant circuit free from substances other than the specified refrigerant (R32), such as air.  
(Any presence of air or other foreign substance in the refrigerant circuit causes an abnormal pressure rise or rupture, resulting in injury.)
- During pump-down, stop the compressor before removing the refrigerant piping.  
If the compressor is still running and the stop valve is open during pump-down, air will be sucked in when the compressor is run, causing abnormal pressure in the freezer cycle which will lead to breakage and even injury.
- Be sure to establish an earth. Do not earth the unit to a utility pipe, arrester, or telephone earth.   
Incomplete earth may cause electrical shock, fire, or explosion. A high surge current from lightning or other sources may cause damage to the air conditioner.  
The installation of pipe-work shall be kept to a minimum.  
Pipe-work shall be protected from physical damage and shall not be installed in an unventilated space, if that space is smaller than the Minimum Room Area specified in the table on the following pages.  
Mechanical connections shall be accessible for maintenance purposes.  
Information for handling, installation, cleaning, servicing and disposal of refrigerant.  
Warning: Keep any required ventilation openings clear of obstruction.  
Notice: Servicing shall be performed only as recommended by this manual instruction.
- Be sure to install an earth leakage breaker.  
Failure to install an earth leakage breaker may result in electric shocks, fire, or explosion.



## CAUTION

- Do not install the air conditioner in a place where there is danger of exposure to inflammable gas leakage. If the gas leaks and builds up around the unit, it may catch fire or explosion. 
- Establish drain piping according to the instructions of this manual. Inadequate piping may cause flooding.
- Tighten the flare nut according to the specified method such as with a torque wrench. If the flare nut is tightened too hard, the flare nut may crack after a long time and cause refrigerant leakage.
- Make sure to provide for adequate measures in order to prevent that the outdoor unit be used as a shelter by small animals. Small animals making contact with electrical parts can cause malfunctions, smoke fire, or explosion. Please instruct the customer to keep the area around the unit clean.

### Loading and Unloading/Transporting Management/Storage Requirements

#### ● Loading and Unloading Requirements

- 1) The products shall be carefully handled during loading and unloading.
- 2) Rude and barbarous handling such as kicking, throwing, dropping, bumping, pulling and rolling is not allowed.
- 3) The workers engaged in loading and unloading must be subject to necessary trainings on the potential hazards caused by barbarous handling.
- 4) Dry powder extinguishers or other suitable fire extinguishing apparatus within the period of validity shall be equipped at the loading and unloading site.
- 5) The untrained personnel cannot be engaged in loading and unloading of flammable refrigerants air conditioner.
- 6) Before loading and unloading, anti-static measures shall be taken, and phones cannot be answered during loading and unloading.
- 7) Smoking and open fire are not allowed around the air conditioner.

#### ● Transporting Management Requirements

- 1) The maximum transporting volume of finished products shall be determined as per local regulations.
- 2) The vehicles used for transporting shall be operated as per local laws and regulations.
- 3) Dedicated after-sales vehicles shall be used for maintenance, and exposed transporting of refrigerant cylinders and the products to be maintained is not allowed.
- 4) The rain cover or similar shielding material of transporting vehicles shall be provided with certain flame retardancy.
- 5) Leakage warning device of flammable refrigerant shall be installed inside the closed-type compartment.
- 6) Anti-static device shall be equipped inside the compartment of transporting vehicles.
- 7) Dry powder extinguishers or other suitable fire extinguishing apparatus within the period of validity shall be equipped inside the driver's cab.
- 8) Orange-white or red-white reflective stripes shall be pasted on the sides and tail of the transporting vehicles, to remind the vehicles behind of keeping distance.
- 9) The transporting vehicles shall run at a constant speed, and heavy acceleration/deceleration shall be avoided.
- 10) Combustibles or the static articles cannot be transported simultaneously.
- 11) High-temperature area shall be avoided during transporting, and necessary radiating measures shall be taken in case the temperature inside the compartment is too high.

#### ● Storage Requirements

- 1) The storage package of equipment used shall be such that no leakage of refrigerant will be caused due to mechanical damage of the equipment inside.
- 2) The appliance must be stored in a room without continuously operating ignition sources, the radius of the storage area should be no less than 2.5 m (for example: open flames, an operating gas appliance or an operating electric heater).
- 3) Do not pierce or burn.
- 4) The maximum quantity of the equipment allowed to be stored together shall be determined as per local regulations.

### Installation Instructions

#### ● Installation Precautions

##### WARNING!

- ★ The area of the room in which R32 refrigerant air conditioner is installed cannot be less than the minimum area specified in the table below, to avoid potential safety problems due to out-of-limit of refrigerant concentration inside the room caused by leakage of refrigerant from refrigeration system of the indoor unit.
- ★ Once the horn mouth of connecting lines is fastened, it may not be used again (the air tightness may be affected).
- ★ A whole connector wire shall be used for indoor/outdoor unit as required in the operation specification of installation process and operation instructions.

### Minimum Room Area

Type	LFL kg/m <sup>3</sup>	hv m	Total Mass Charged/kg Minimum Room Area/m <sup>2</sup>						
			1.224	1.836	2.448	3.672	4.896	6.12	7.956
R32	0.306	0.6		29	51	116	206	321	543
		1.0		10	19	42	74	116	196
		1.8		3	6	13	23	36	60
		2.2		2	4	9	15	24	40

#### ● Safety Awareness

- 1.Procedures: operation shall be made as per controlled procedures to minimize the probability of risks.
- 2.Area: area shall be divided and isolated appropriately, and operation in an enclosed space shall be avoided. Before the refrigeration system is started or **before working**, ventilation or opening of the area shall be guaranteed.
- 3.Site inspection: the refrigerant shall be checked.
- 4.Fire control: the fire extinguisher shall be placed nearby, and fire source or high temperature is not allowed; the sign of "No smoking" shall be arranged.

#### ● Unpacking Inspection

- 1.Indoor unit: nitrogen is sealed during the delivery of indoor units (inside the evaporator), and the red sign at the top of the green plastic seal cap on the evaporator air pipes of the indoor unit shall be checked first after unpacking. In case the sign is raised, the nitrogen sealed still exists. Afterwards, the black plastic seal cap at the joint of evaporator liquid pipes of the indoor unit shall be pressed, to check whether nitrogen still exists. In case no nitrogen is sprayed out, the indoor unit is subject to leakage, and installation is not allowed.
- 2.Outdoor unit: the leak detection equipment shall be extended into the packing box of the outdoor unit, to check whether the refrigerant is leaking. If the refrigerant leakage is identified, installation is not allowed, and the outdoor unit shall be delivered to the maintenance department.

#### ● Inspection on Installation Environment

- 1.The room area checked cannot be less than the area specified on the warning sign of the indoor unit.
- 2.Inspection on the surrounding environment of place of installation: the outdoor unit of flammable refrigerants air conditioner cannot be installed inside an enclosed room reserved.
- 3.Power supply, switches or other high-temperature articles such as the fire source and oil heater shall be avoided below the indoor unit.
- 4.The power supply shall be provided with earthing wire and be reliably earthed.
- 5.While punching the wall with an electric drill, whether embedded water/electricity/gas pipelines are designed at the hole preset by the user shall be verified in advance. It is recommended that the through-wall holes reserved shall be used as much as possible

#### ● Safety Principles of Installation

1. Favorable ventilation shall be maintained at the place of installation (doors and windows are opened).
2. Open fire or high-temperature heat source (including welding, smoking and oven) higher than 548 °C is not allowed within the scope of flammable refrigerant.
3. Anti-static measures shall be taken, such as the wearing of cotton clothes and cotton gloves.
4. The place of installation shall be convenient for installation or maintenance. Barriers shall be avoided around the air inlet/outlet of the indoor/outdoor unit, and the electrical appliance, power switches, sockets, valuables and high-temperature products within the scope of both sidelines of the indoor unit shall be avoided, and cannot be adjacent to heat source and flammable and combustible environment.
5. In case of refrigerant leakage of the indoor unit during installation, the valve of the outdoor unit shall be closed immediately, and windows shall be opened, and all the personnel shall be evacuated. After the leakage of refrigerant is handled, the indoor environment shall be subject to concentration detection. Further handling is not allowed until the safety level is reached.
6. In case the product is damaged, it must be delivered to the maintenance point. Welding of refrigerant pipelines at the user's site is not allowed.



Caution, risk of fire



No Smoking



Cotton clothes



Anti-static gloves



BEWARE  
ELECTROSTATICS



Goggles

## ●Electrical Safety Requirements

- 1.The surrounding conditions (ambient temperature, direct sunlight and rainwater) shall be noticed during electrical wiring, with effective protective measures being taken.
- 2.Copper wire cable in line with local standards shall be used as the power line and connector wire.
- 3.Both the indoor unit and outdoor unit shall be reliably earthed.
- 4.Wiring for the outdoor unit shall be made first and then the indoor unit. The air conditioner can only be powered on after wiring and pipe connection.
- 5.The dedicated branch circuit must be used, and leakage protector with sufficient capacity must be installed.

## ●Qualification Requirements of Installer

Relevant qualification certificate must be obtained as per national laws and regulations.

## ●Indoor Unit Installation

### 1.Fixing of wall panel and piping layout

In case of left/right water pipe connection for the indoor unit, or in case the evaporator interface of the indoor unit and the horn mouth of the connecting piping cannot be extended to the outdoor side for installation, the connector pipes shall be connected to the evaporator piping interface of the indoor unit in the process of horn mouth.

### 2. Piping layout

During layout of connecting pipes, drain hose and connector wires, the drain hose and connecting wire shall be placed at the bottom and top respectively. The power line cannot be twined with the connector wire. The drain pipes (especially inside the room and machine) must be winded with thermal insulation materials.

### 3. Nitrogen charging for pressure maintaining and leak detection

After the evaporator of the indoor unit is connected to the connector pipe (after welding), nitrogen more than 4.0MPa shall be charged inside the evaporator and the piping connected to evaporator with a nitrogen cylinder(adjusted by a reducing valve). Afterwards, the valve of the nitrogen cylinder shall be closed, for leak detection with soapy water or leak detecting solution. The pressure shall be maintained for more than 5 minutes, and then whether the system pressure is reduced or not shall be observed. In case the pressure is reduced, leakage can be identified. After the leak point is handled, the steps above shall be repeated.

After the evaporator of the indoor unit is connected to connecting piping, nitrogen shall be charged for pressure maintaining and leak detection. Afterwards, the evaporator shall be connected to the two-way stop valve and three-way stop valve of the outdoor unit. After the copper cap of the connecting piping is fastened, nitrogen more than 4.0MPa shall be charged at the access hole of the three-way stop valve with a charging hose. The valve of the nitrogen cylinder shall be closed, for leak detection with soapy water or leak detecting solution. The pressure shall be maintained for more than 5 minutes, and then whether the system pressure is reduced or not shall be observed. In case the pressure is reduced, leakage can be identified. After the leak point is handled, the steps above shall be repeated.

The next step (vacuumizing with a vacuum pump) can only be continued after the installation steps (nitrogen charging for pressure maintaining and leak detection normal) are completed.

## ●Outdoor Unit Installation

### 1.Fixing and connection

Note:

- a) Fire source shall be avoided within 3m around the place of installation.
- b) The leak detection equipment of refrigerant shall be placed at a low position in the outdoor, and shall be opened.





### 1) Fixing

The support of the outdoor unit shall be fixed onto the wall surface, and then the outdoor unit shall be fixed onto the support horizontally. In case the outdoor unit is wall-mounted or roof-mounted, the support shall be firmly fixed, to avoid the damage of strong wind.

### 2) Installation of connecting pipes

The cone of the connecting pipes shall be aligned with the conical surface of corresponding valve connector. The nut of connecting pipes shall be installed at a proper position and then be tightened with a spanner. Excessive tightening torque shall be avoided, or otherwise the nut may be damaged.

## ● Vacuumizing

A digital vacuum gauge shall be connected for vacuumizing. The duration of vacuumizing shall be at least 15 minutes, and the pressure of the vacuum gauge shall be below 60Pa. Afterwards, the vacuumizing equipment shall be closed, and whether the reading of the digital vacuum gauge is increased or not shall be observed after the pressure is maintained for 5 minutes. In case no leakage is identified, the two-way stop valve and three-way stop valve of the outdoor unit may be opened. Finally, the vacuumizing hose connected to the outdoor unit can be disassembled.

## ● Leak Detection

The joint of connecting pipes for the outdoor unit shall be subject to leak detection with soap bubble or dedicated leak detection equipment.

## ● Post-installation Inspection Items and Test Run

### Post-installation Inspection Items

Items to Be Checked	Consequence of Improper Installation
Whether the installation is firm or not	The unit may fall, vibrate or make a noise
Whether the inspection on air leakage is completed	The refrigerating capacity (heating capacity) may be insufficient
Whether the unit is fully insulated	Condensation or drip may occur
Whether the drainage is smooth or not	Condensation or drip may occur
Whether the power voltage is identical to that marked on the nameplate	Failure may occur or the parts may be burned
Whether the circuit and pipeline are installed correctly	Failure may occur or the parts may be burned
Whether the unit is safely earthed	Electric leakage may occur
Whether the type of wire is in line with relevant regulations	Failure may occur or the parts may be burned
Whether barriers are identified at the air inlet/outlet of the indoor/outdoor unit	The refrigerating capacity (heating capacity) may be insufficient
Whether the length of refrigerant pipes and the refrigerant amount charged are recorded	The refrigerant amount charged cannot be confirmed

## Test Run

### 1. Preparations

- (1) Check the power supply.
- (2) Check the equipment around, whether there is any combustible source, fire source, or heat source.
- (3) Power on is not allowed before all the installation operations are completed and before the leak detection is proven qualified.
- (4) The control circuit shall be connected correctly and all the wires shall be firmly connected.
- (5) The two-way stop valve and three-way stop valve shall be opened.
- (6) All the scattered articles (especially the metal filing and thread residue) shall be removed from the unit body.

### 2. Methods

- (1) Switch on the power supply and press the "ON/OFF" on the remote controller, after which the air conditioner will start operating.
- (2) Press "Mode" to select refrigeration, heating and sweeping wind, and observe whether the air conditioner is under normal operation.

## Relocation Procedures

- Please call the dealer or the appointed agency.
- Follow the following procedures:

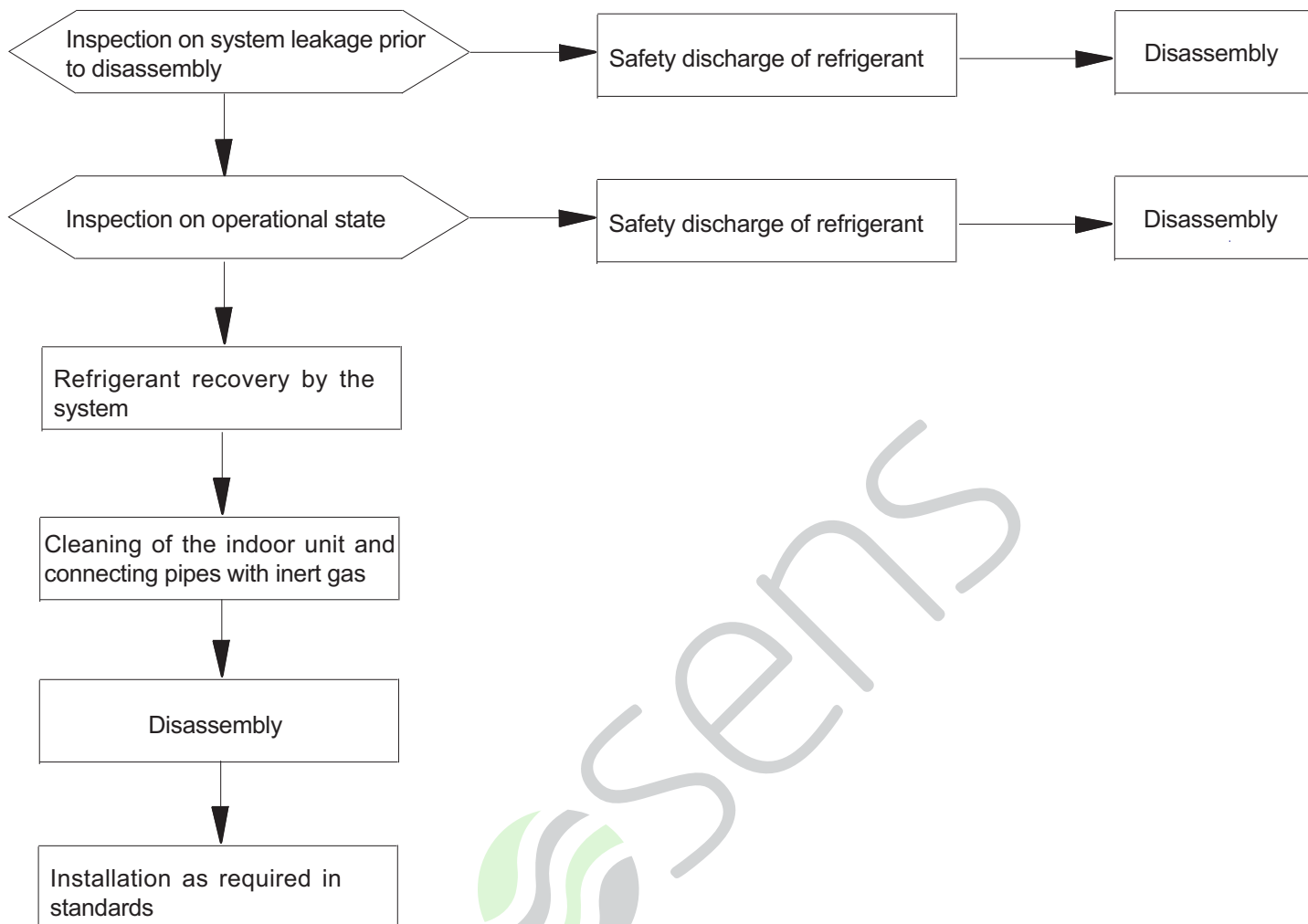

Note: in case relocation is required, the joint of evaporator gas/liquid pipes of the indoor unit shall be cut off with a cutting knife. Connection is only allowed after re-flaring (the same to the outdoor unit).

## Maintenance Instructions

### Maintenance Precautions

#### Precautions

- For all the faults requiring welding the refrigeration pipelines or components inside the refrigeration system of R32 refrigerant air conditioners, maintenance at the user's site is never allowed.
- For the faults requiring radical disassembly and bending operation of the heat exchanger, such as the replacement of the outdoor unit chassis and integral disassembly of the condenser, inspection and maintenance at the user's site are never allowed.
- For the faults requiring replacement of the compressor or parts & components of refrigeration system, maintenance at the user's site is not allowed.
- For other faults not involved in the refrigerant container, internal refrigeration pipelines and refrigeration elements, the maintenance at the user's site is allowed, including the cleaning and dredging of the refrigeration system requiring no disassembly of refrigeration elements and no welding.
- In case replacement of gas/liquid pipes is required during maintenance, the joint of evaporator gas/liquid pipes of the indoor unit shall be cut off with a cutting knife. Connection is only allowed after re-flaring (the same to the outdoor unit).

#### Qualification Requirements of Maintenance Personnel

1. All the operators or the maintenance personnel involved in refrigerating circuits shall be provided with the effective certificate issued by an industry-accepted assessment institute, to ensure that they are qualified for safety disposal of refrigerant as required in the assessment regulations.
2. The equipment can only be maintained and repaired as per the method recommended by the manufacturer. In case the assistance from personnel of other disciplines is required, the assistance shall be supervised by the personnel with qualification certificate involved in flammable refrigerant.

---

### **Inspection on Maintenance Environment**

- Before operation, the refrigerant leaked in the room is not allowed.
- The area of the room in which maintenance is made shall be in line with this manual.
- Continuous ventilation shall be maintained during maintenance.
- Open fire or high-temperature heat source higher than 548 degree which can easily give birth to open fire is not allowed inside the room within the maintenance area.
- During maintenance, the phones and the radioactive electronics of all the operators inside the room must be powered off.
- One dry powder or carbon dioxide extinguisher shall be equipped inside the maintenance area, and the extinguisher must be under available state.

### **Maintenance Site Requirements**

- The maintenance site shall be provided with favorable ventilation and must be flat. Arrangement of the maintenance site inside the basement is not allowed.
- Welding zone and non-welding zone shall be divided at the maintenance site, and shall be clearly marked. A certain safety distance must be guaranteed between the two zones.
- Ventilators shall be installed at the maintenance site, and exhaust fans, fans, ceiling fans, floor fans and dedicated exhaust duct can be arranged, to meet the requirements of ventilation volume and uniform exhaust, and to avoid accumulation of refrigerant gas.
- Leak detection equipment for flammable refrigerant shall be equipped, with relevant management system being established. Whether the leak detection equipment is under available state shall be confirmed before maintenance.
- Sufficient dedicated vacuum pumps of flammable refrigerant and refrigerant charging equipment shall be equipped, with relevant management system for maintenance equipment being established. It shall be guaranteed that the maintenance equipment can only be used for vacuumizing and charging of one type of flammable refrigerant, and mixed usage is not allowed.
- The master power switch shall be arranged outside the maintenance site, with protective (anti-explosive) device being equipped.
- Nitrogen cylinders, acetylene cylinders and oxygen cylinders shall be placed separately. The distance between the gas cylinders above and the working area involved in open fire shall be at least 6m. The anti-backfire valve shall be installed for the acetylene cylinders. The color of the acetylene cylinders and oxygen cylinders installed shall meet the international requirements.
- The warning sign of " No Fire" , "No Smoking", or "Anti static" shall be arranged inside the maintenance area.
- Fire control device suitable for electric appliance such as the dry powder extinguisher or carbon dioxide extinguisher shall be equipped, and shall always be under the available state.
- The ventilator and other electrical equipment at the maintenance site shall be relatively fixed, with standardized pipe routing. Temporary wires and sockets at the maintenance site are not allowed.

### **Leak Detection Methods**

- The environment in which the refrigerant leakage is checked shall be free from potential ignition source. Leak detection with halogen probes (or any other detector with open fire) shall be avoided.
- For the system containing flammable refrigerant, leak detection may be realized with electronic leak detection equipment. During leak detection, the environment in which the leak detection equipment is calibrated shall be free from refrigerant. It shall be guaranteed that the leak detection equipment will not become potential ignition source, and is applicable to the refrigerant to be detected. Leak detection equipment shall be set at a percentage of the LFL of the refrigerant and shall be calibrated to the refrigerant employed, and the appropriate percentage of gas (25 % maximum) is confirmed.
- The fluid used for leak detection shall be applicable to most of the refrigerant. The use of chlorine-containing solvent shall be avoided, to avoid chemical reaction between chlorine and refrigerant and corrosion to copper pipelines.
- In case leakage is suspected, the open fire at the site shall be evacuated or be put out.
- In case welding is required at the leakage position, all the refrigerants shall be recovered, or be isolated at a position far from the leak point with a stop valve. Before and during welding, the whole system shall be purified with OFN.

### **Safety Principles**

- The power supply should be cut off before the maintenance .
- During product maintenance, favorable ventilation shall be guaranteed at the maintenance site, and the close of all the doors/windows is not allowed.
- Operation with open fire is not allowed, including welding and smoking. The use of phones is also not allowed. The user shall be informed that cooking with open fire is not allowed.
- During maintenance in a dry season, when the relative humidity is less than 40%, anti-static measures shall be taken, including the wearing of cotton clothes and cotton gloves.
- In case the leakage of flammable refrigerant is identified during maintenance, forced ventilation measures shall be taken immediately, and the source of leak shall be plugged.
- In case the product damaged must be maintained by disassembling the refrigeration system, the product must be delivered to the maintenance point. Welding of refrigerant pipelines at the user's site is not allowed.
- During maintenance, in case re-treatment is required due to lack of fittings, the air conditioner shall be reset.
- The refrigeration system must be safely earthed in the whole course of maintenance.
- For the door-to-door service with refrigerant cylinders, the refrigerant charged inside the cylinder cannot exceed the specified value. The cylinder placed in vehicles or at the installation/maintenance site shall be fixed perpendicularly and be kept away from heat sources, ignition source, source of radiation and electric appliance.

---

## Maintenance Items

### Maintenance Requirements

- Before the refrigeration system is operated, the circulating system shall be cleaned with nitrogen. Afterwards, the outdoor unit shall be vacuumized, the duration of which cannot be less than 30 minutes. Finally, 1.5~2.0MPa OFN shall be used for nitrogen flushing (30 seconds~1 minute), to confirm the position requiring treatment. Maintenance of the refrigeration system is only allowed after the residual gas of flammable refrigerant is removed.
- During the use of refrigerant charging tools, cross contamination of different refrigerants shall be avoided. The total length (including the refrigerant pipelines) shall be shortened as much as possible, to reduce the residual of refrigerant inside.
- The cylinders of refrigerant shall be kept upright, and be fixed.
- Before refrigerant charging, the refrigeration system shall be earthed.
- The refrigerant charged shall be of the type and volume specified on the nameplate. Excessive charging is not allowed.
- After maintenance of the refrigeration system, the system shall be sealed with a safe manner.
- The maintenance in progress shall not damage or lower the original class of safety protection of the system.

### Maintenance of Electrical Components

- Partial of the electrical component under maintenance shall be subject to inspection on refrigerant leakage with dedicated leak detection equipment.
- After the maintenance, the components with safety protection functions cannot be disassembled or removed.
- During the maintenance of sealing elements, before opening the seal cover, the air conditioner shall be powered off first. When power supply is required, continuous leak detection shall be carried out at the most dangerous position, to avoid potential risks.
- During maintenance of electrical components, the replacement of enclosures shall not affect the level of protection.
- After maintenance, it shall be guaranteed that the sealing functions will not be damaged or the sealing materials will not lose the function of preventing the entry of flammable gas due to aging. The substitute components shall meet the recommended requirements of the air conditioner manufacturer.

### Maintenance of Intrinsically Safe Elements

- The intrinsically safe element refers to the components working continuously inside flammable gas without any risks.
- Before any maintenance, leak detection and inspection on earthing reliability of the air conditioner must be carried out, to ensure no leakage and reliable earthing.
- In case the allowable voltage and current limit may be surpassed during the service of the air conditioner, any inductance or capacitance cannot be added in the circuit.
- Only the elements appointed by the air conditioner manufacturer can be used as the parts and components replaced, or otherwise a fire or explosion may be triggered in case of refrigerant leakage.
- For the maintenance not involved in system pipelines, the system pipelines shall be well protected, to ensure that no leakage will be caused due to maintenance.
- After maintenance and before test run, the air conditioner must be subject to leak detection and inspection on earthing reliability with leak detection equipment or leak detecting solution. It shall be guaranteed that the startup inspection is carried out without leakage and under reliable earthing.

### Removal and Vacuumizing

- The maintenance or other operations of the refrigeration circuit shall be made as per conventional procedures. Moreover, the flammability of refrigerant shall also be mainly considered. The following procedures shall be followed:
  - Refrigerant cleaning;
  - Pipeline purification with inert gas;
  - Vacuumizing;
  - Pipeline purification again with inert gas;
  - Pipeline cutting or welding. The refrigerant shall be recovered to a proper cylinder. The system shall be purged with OFN, to ensure safety. The step above may need to be repeated for several times. Compressed air or oxygen cannot be used for purging.

In the course of purging, OFN shall be charged inside the refrigeration system under vacuum state, to reach the operating pressure. Afterwards, the OFN shall be discharged to the atmosphere. Finally, the system shall be vacuumized. The step above shall be repeated until all the refrigerants in the system are cleared. The OFN charged for the last time shall be discharged to the atmosphere. Afterwards, the system can be welded. The operation above is necessary in case of pipeline welding.

It shall be guaranteed that no alight fire source is around the outlet of the vacuum pump and the ventilation is favorable.

### Welding

- Favorable ventilation must be guaranteed in the maintenance area. After the maintenance machine is subject to the vacuumizing above, the system refrigerant can be discharged on the outdoor unit side.
- Before the outdoor unit is welded, it must be guaranteed that no refrigerant is inside the outdoor unit and the system refrigerant has been discharged and cleared.
- The refrigeration pipelines cannot be cut with a welding gun under any circumstance. The refrigeration pipelines must be disassembled with a pipe cutter, and the disassembly must be carried out around a ventilation opening

## Refrigerant Charging Procedures

The following requirements are added as the supplementation of conventional procedures:

- During the use of refrigerant charging tools, cross contamination of different refrigerants shall be avoided. The total length (including the refrigerant pipelines) shall be shortened as much as possible, to reduce the residual of refrigerant inside;
- The cylinders of refrigerant shall be kept upright;
- Before refrigerant charging, the refrigeration system shall be earthed;
- A label must be pasted on the refrigeration system after refrigerant charging;
- Excessive charging is not allowed; the refrigerant shall be charged slowly;
- In case system leakage is identified, refrigerant charging is not allowed unless the leak point is repaired;
- During refrigerant charging, the charging amount shall be measured with an electronic scale or a spring scale. The connecting hose between the refrigerant cylinder and the charging equipment shall be relaxed appropriately, to avoid impact on the measuring accuracy due to stress.

### Requirements on storage site of refrigerant

- The cylinder of refrigerant shall be placed in a -10~50°C environment with favorable ventilation, and warning labels shall be pasted;
- The maintenance tool in contact with the refrigerant shall be stored and used separately, and the maintenance tool of different refrigerants cannot be mixed.

## Scrapping and Recovery

### Scrapping

Before scrapping, the technician shall be completely familiar with the equipment and all its features. The safe recovery of refrigerant is recommended. In case the refrigerant recovered needs to be reused, before which the sample of refrigerant and oil shall be analyzed.

- (1) The equipment and operation shall be well known;
- (2) Power supply shall be switched off;
- (3) The followings shall be guaranteed before scrapping:
  - The mechanical equipment shall be convenient for operation on the cylinder of refrigerant (if necessary);
  - All personal protective equipment is available and being used correctly;
  - The whole course of recovery shall be guided by qualified personnel;
  - The recovery equipment and cylinders shall be in line with corresponding standards.
- (4) The refrigeration system shall be vacuumized if possible;
- (5) In case the vacuum state cannot be reached, vacuumizing shall be carried out from numerous positions, to pump the refrigerant in each part of the system out;
- (6) It shall be guaranteed that the capacity of cylinders is sufficient before recovery;
- (7) The recovery equipment shall be started and operated as per the operation instructions of the manufacturer;
- (8) The cylinder cannot be charged too full. (The refrigerant charged cannot exceed 80% of the capacity of cylinders)
- (9) The maximum operating pressure of cylinders cannot be surpassed even only lasting for a short term;
- (10) After refrigerant recovery is completed, the cylinder and equipment must be evacuated rapidly, and all the stop valves on the equipment must be closed;
- (11) Before purification and tests, the refrigerant recovered cannot be charged into another refrigeration system.

### Note:

**The air conditioner shall be marked (with dates and signature) after being scrapped and the refrigerant is discharged. It shall be guaranteed that the sign on the air conditioner can reflect the flammable refrigerant charged inside.**

### Recovery

During maintenance or scrapping, the refrigerant inside the refrigeration system needs to be cleared. It is recommended that the refrigerant be cleared thoroughly.

The refrigerant can only be charged into a dedicated cylinder, the capacity of which shall match with the refrigerant amount charged in the whole refrigeration system. All cylinders to be used are designated for the recovered refrigerant and labeled for that refrigerant (Dedicated Cylinder for Refrigerant Recovery). The cylinders shall be equipped with pressure relief valves and stop valves under favorable state. The empty cylinder shall be vacuumized before usage and be kept under normal temperature.

The recovery equipment shall always be under favorable working state, and be equipped with operation instructions, to facilitate information search. The recovery equipment shall be applicable to the recovery of flammable refrigerant. Moreover, weighing apparatus under available state with measurement certificates shall be equipped. In addition, removable attachment joints free from leakage shall be used as the hose, and shall always be under favorable state. Whether the recovery equipment is under favorable state and is properly maintained and whether all the electrical components are sealed shall be checked before usage, to avoid fire or explosion in case of refrigerant leakage. If you have any question, please consult the manufacturer.

The refrigerant recovered shall be delivered back to the manufacturer in appropriate cylinders, with transporting instructions being attached. Mixing of refrigerant in recovery equipment (especially the cylinders) is not allowed.

During transporting, the space in which the flammable refrigerant air conditioners are loaded cannot be sealed. Anti-static measures shall be taken for the transporting vehicles. Meanwhile, during the transporting, loading and unloading of air conditioners, necessary protective measures shall be taken, to protect the air conditioner from being damaged.

During removal of the compressor or clearing of the compressor oil, it shall be guaranteed that the compressor is vacuumized to a proper level, to ensure no residual flammable refrigerant is left inside the lubricating oil. The vacuumizing shall be completed before the compressor is delivered back to the manufacturer. The vacuumizing can only be accelerated by heating the compressor housing through electrical heating. Safety shall be guaranteed when the oil is discharged from the system. Disassembled with a pipe cutter, and the disassembly must be carried out around a ventilation opening



Carefully read the following information in order to operate the air conditioner correctly.

Below are listed three kinds of Safety Precautions and Suggestions.

**⚠ WARNING** Incorrect operations may result in severe consequences of death or serious injuries.

**⚠ CAUTION** Incorrect operations may result in injuries or machine damages; in some cases may cause serious consequences.

**INSTRUCTIONS:** These information can ensure the correct operation of the machine.

The following safety symbols are used throughout this manual:

⊘: Indicates an action that must be avoided.





ⓘ: Indicates that important instructions must be followed.



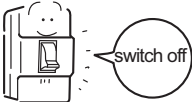

⚡: Indicates a part which must be grounded.

⚡: Beware of electric shock (This symbol is displayed on the main unit label.)

After completing installation, test the unit to check for installation errors. Give the user adequate instructions **concerning** the use and cleaning of the unit according to the Operation Manual.

Be sure to conform with the following important Safety Precautions.

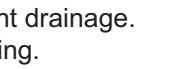
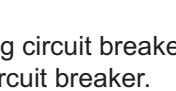
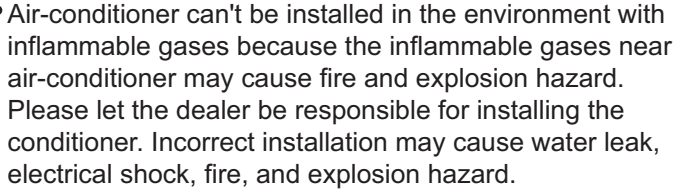
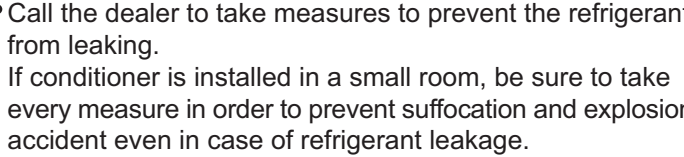
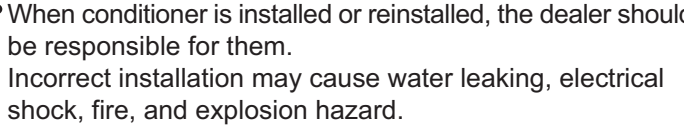
<b>⚠ WARNING</b>	
<ul style="list-style-type: none"> <li>• If any abnormal phenomena is found (e. g. smell of firing), please open the window and well ventilated the room immediately, then cut off the power supply immediately, and contact the dealer to find out the handling method. In such case, to continue using the conditioner will damage the conditioner, and may cause electrical shock, fire, or explosion hazard.</li> </ul>	
<ul style="list-style-type: none"> <li>• After a long time use of air-conditioner, the base should be checked for any damages. If the damaged base is not repaired, the unit may fall down and cause accidents.</li> </ul>	
<ul style="list-style-type: none"> <li>• Don't dismantle the outlet of the outdoor unit. The exposure of fan is very dangerous which may harm human beings.</li> </ul>	
<ul style="list-style-type: none"> <li>• When need maintenance and repairment, call dealer to handle it. Incorrect maintenance and repairment may cause water leak, electrical shock, fire, and explosion hazard.</li> </ul>	

<b>⚠ WARNING</b>	
<ul style="list-style-type: none"> <li>• No goods or nobody is permitted to placed on or stand on outdoor unit. The falling of goods and people may cause accidents.</li> </ul>	
<ul style="list-style-type: none"> <li>• Don't operate the air-conditioner with damp hands. Otherwise it will be shocked.</li> </ul>	
<ul style="list-style-type: none"> <li>• Only use correctly-typed fuse. May not use wire or any other materials replacing fuse, otherwise it may cause faults or fire accidents.</li> </ul>	
<ul style="list-style-type: none"> <li>• Use drain pipe correctly to ensure efficient drainage. Incorrect pipe use may cause water leaking.</li> </ul>	
<ul style="list-style-type: none"> <li>• Installed explosion-proof electrical-leaking circuit breaker. It easily cause electrical shock without circuit breaker.</li> </ul>	
<ul style="list-style-type: none"> <li>• Air-conditioner can't be installed in the environment with inflammable gases because the inflammable gases near air-conditioner may cause fire and explosion hazard. Please let the dealer be responsible for installing the conditioner. Incorrect installation may cause water leak, electrical shock, fire, and explosion hazard.</li> </ul>	
<ul style="list-style-type: none"> <li>• Call the dealer to take measures to prevent the refrigerant from leaking. If conditioner is installed in a small room, be sure to take every measure in order to prevent suffocation and explosion accident even in case of refrigerant leakage.</li> </ul>	
<ul style="list-style-type: none"> <li>• When conditioner is installed or reinstalled, the dealer should be responsible for them. Incorrect installation may cause water leaking, electrical shock, fire, and explosion hazard.</li> </ul>	
<ul style="list-style-type: none"> <li>• Connect earthing wire. Earthing wire should not be connected to the gas pipe, water pipe, lightning rod or phone line, incorrect earthing may cause shock.</li> </ul>	 <p style="text-align: right;">Earthing</p>

**⚠ WARNING**

- |  |  |
|--|--|
| <ul style="list-style-type: none"><li>• Have the unit professionally installed. Improper installation by an unqualified person may result in water leak, electric shock, fire, or explosion.</li><li>• Place the unit on a stable, level surface that withstands the weight of the unit to prevent the unit from tipping over or falling causing injury as a result.</li><li>• Only use specified cables for wiring. Securely connect each cable, and make sure that the cables are not straining the terminals. Cables not connected securely and properly may generate heat and cause fire and explosion.</li><li>• Take necessary safety measures against typhoons and earthquakes to prevent the unit from falling over.</li><li>• Do not make any changes or modifications to the unit. In case of problems, consult the dealer. If repairs are not made properly, the unit may leak water and present a risk of electric shock, or it may produce smoke or cause fire and explosion.</li></ul> | <ul style="list-style-type: none"><li>• Be sure to carefully follow each step in this handbook when installing the unit. Improper installation may result in water leak, electric shock, smoke or fire.</li><li>• Have all electrical work performed by a licensed electrician according to the local regulations and the instructions given in this manual. Secure a circuit designated exclusively to the unit. Improper installation or a lack of circuit capacity may cause the unit to malfunction or present a risk of electric shock, smoke, and fire.</li><li>• Securely attach the terminal cover(panel) on the unit. If installed improperly, dust and/or water may enter the unit and present a risk of electric shock, smoke, fire, or explosion.</li><li>• Only use refrigerant R32 as indicated on the unit when installing or relocating the unit. The use of any other refrigerant or an introduction of air into the unit circuit may cause the unit to run an abnormal cycle and abnormal cycle and cause the unit to burst.</li></ul> |
|--|--|

**⚠ WARNING**

- |  |   |
|--|---|
| <ul style="list-style-type: none"><li>• Do not touch the fins on the heat exchanger with bare hands, for they are sharp and dangerous.</li><li>• In the event of a refrigerant gas leak, provide adequate ventilation to the room. If leaked refrigerant gas is exposed to a heat source, noxious gases, fire or explosion will be caused.</li><li>• Do not try to defeat the safety features of the devices, and do not change the settings. Defeating the safety features on the unit such as the pressure switch and temperature switch or using parts other than the dealer or specialist may result in fire or explosion.</li></ul> | <ul style="list-style-type: none"><li>• When installing the unit in a small room, safeguard against hypoxia that results from leaked refrigerant reaching the threshold level. Consult the dealer for necessary measures to take.</li><li>• When relocating the air conditioner, consult the dealer or a specialist. Improper installation may result in water leak, electric shock, or fire.</li><li>• After completing the service work, check for a refrigerant gas leak. If leaked gas refrigerant is exposed to a heat source such as fan heater, stove, and electric grill, noxious gases may form.</li><li>• Only use specified parts. Have the unit professionally installed. Improper installation may cause water leak, electric shock, smoke, fire, explosion.</li></ul> |
|--|---|

## Precautions for Handling Units for Use with R32

### ⚠ Caution

Do not use the existing refrigerant piping

- The old refrigerant and refrigerator oil in the existing piping contain a large amount of chlorine, which will cause the refrigerator oil in the new unit to deteriorate.
- R32 is a high-pressure refrigerant, and the use of the existing piping may result in bursting.

Keep the inner and outer surfaces of the pipes clean and free of contaminants such as sulfur, oxides, dust/dirt shaving particles, oils, and moisture.

- Contaminants inside the refrigerant piping will cause the refrigerant oil to deteriorate.

Use a vacuum pump with a reverse-flow check valve.

- If other types of valves are used, the vacuum pump oil will flow back into the refrigerant cycle and cause the refrigerator oil to deteriorate.

Do not use the following tools that have been used with the conventional refrigerants. Prepare tools that are for exclusive use with R32.

(Gauge manifold, charging hose, gas leak detector, reverse-flow check valve, refrigerant charge base, vacuum gauge, and refrigerant recovery equipment.)

- If refrigerant and/or refrigerant oil left on these tools are mixed in with R32, or if water is mixed with R32, it will cause the refrigerant to deteriorate.
- Since R32 does not contain chlorine, gas-leak detectors for conventional refrigerators will not work.

### ⚠ Caution

Store the piping to be used during installation indoors, and keep both ends of the piping sealed until immediately before brazing. (keep elbows and other joints wrapped in plastic.)

- If dust, dirt, or water enters the refrigerant cycle, it may cause the oil in the unit to deteriorate or may cause the compressor to malfunction.

Use a small amount of ester oil, ether oil, or alkylbenzene to coat flares and flange connections.

- A large amount of mineral oil will cause the refrigerating machine oil to deteriorate.

Use liquid refrigerant to charge the system.

- Charge the unit with gas refrigerant will cause the refrigerant in the cylinder to change its composition and will lead to a drop in performance

Do not use a charging cylinder.

- The use of charging cylinder will change the composition of the refrigerant and lead to power loss.

Exercise special care when handling the tools.

- An introduction of foreign objects such as dust, dirt or water into the refrigerant cycle will cause the refrigerating machine oil to deteriorate.

Only use R32 refrigerant.

- The use of refrigerants containing chlorine (i.e. R22) will cause the refrigerant to deteriorate.

## Before Installing the Unit

### ⚠ Caution

Do not install the unit in a place where there is a possibility of flammable gas leak.

- Leaked gas accumulated around the unit may start a fire or explosion.

Do not use the unit to preserve food, animals, plants, artifacts, or for other special purposes.

- The unit is not designed to provide adequate conditions to preserve the quality of these items.

Do not use the unit in an unusual environment

- The use of the unit in the presence of a large amount of oil, steam, acid, alkaline solvents or special types of sprays may lead to a remarkable drop in performance and/or malfunction and presents a risk of electric shock, smoke, fire, or explosion.

- The presence of organic solvents, corroded gas (such as ammonia, sulfur compounds, and acid may cause gas or water leak.)

When installing the unit in a hospital, take necessary measures against noise.

- High-frequency medical equipment may interfere with the normal operation of the air conditioning unit or the air conditioning unit may interfere with the normal operation of the medical equipment

Do not place the unit on or over things that may not get wet.

- When humidity level exceeds 80% or when the drainage system is clogged, indoor units may drip water.
- Installation of a centralized drainage system for the outdoor unit may also need to be considered to prevent water drips from the outdoor units.

## Before Installing (Relocating) the Unit or Performing Electric Work

### ⚠ Caution

Ground the unit.

- Do not connect the grounding on the unit to gas pipes, water pipes, lightning rods, or the grounding terminals of telephones. Improper grounding presents a risk of electric shock, smoke, fire, explosion, or the noise caused by improper grounding may cause the unit to malfunction.

Make sure the wires are not subject to tension.

- If the wires are too taut, they may break or generate heat and/or smoke and cause fire or explosion.

Install a breaker for current leakage at the power source to avoid the risk of electric shock.

- Without a breaker for current leakage, there is a risk of electric shock, smoke or fire.

Use breakers and fuses (electrical current breaker, remote switch<switch+Type-B fuse>, molded case circuit breaker) with a proper current capacity.

- The use of large-capacity fuses, steel wire, or copper wire may damage the unit or cause smoke or fire.

Do not spray water on the air conditioners or immerse the air conditioners in water.

- Water on the unit presents a risk of electric shock.

Periodically check the platform on which is placed for damage to prevent the unit from falling.

- If the unit is left on a damaged platform, it may topple over, causing injury.

When installing draining pipes, follow the instructions in the manual, and make sure that they properly drain water so as to avoid dew condensation.

- If not installed properly, they may cause water leaks and damage the furnishings.

Properly dispose of the packing materials.

- Things such as nails may be included in the package. Dispose of them properly to prevent injury.
- Plastic bags present a choking hazard to children. Tear up the plastic bags before disposing of them to prevent accidents.

## Before the Test Run

### ⚠ Caution

Do not operate switches with wet hands to avoid electric shock.

Do not touch the refrigerant pipes with bare hands during and immediately after operation.

- Depending on the state of the refrigerant in the system, certain parts of the unit such as the pipes and compressor may become very cold or hot and may subject the person to frost bites or burning.

Do not operate the unit without panels and safety guards in their proper places.

- They are there to keep the users from injury for accidentally touching rotating, high-temperature or high-voltage parts.

Do not turn off the power immediately after stopping the unit.

- Allow for at least five minutes before turning off the unit, otherwise the unit may leak water or experience other problems.

Do not operate the unit without air filters.

- Dust particles in the air may clog the system and cause malfunction.

## Move and scrap the air conditioning

- When moving, to disassemble and re-install the air conditioning, please contact your dealer for technical support.
- In the composition material of air conditioning, the content of lead, mercury, hexavalent chromium, polybrominated biphenyls and polybrominated diphenyl ethers are not more than 0.1% (mass fraction) and cadmium is not more than 0.01% (mass fraction).
- Please recycle the refrigerant before scrapping, moving, setting and repairing the air conditioning; for the air conditioning scrapping, should be dealt with by the qualified enterprises.

# Read Before Installation

## Items to Be Checked

- (1) Verify the type of refrigerant used by the unit to be serviced. Refrigerant Type: R32
- (2) Check the symptom exhibited by the unit to be serviced. Look in this service handbook for symptoms relating to the refrigerant cycle.
- (3) Be sure to carefully read the safety precautions at the beginning of this document.
- (4) If there is a gas leak or if the remaining refrigerant is exposed to an open flame, a noxious gas hydrofluoric acid may form. Keep workplace well ventilated.

## CAUTION

- Install new pipes immediately after removing old ones to keep moisture out of the refrigerant circuit.
- Chloride in some types of refrigerants such as R22 will cause the refrigerating machine oil to deteriorate.

## Necessary Tools and Materials

Prepare the following tools and materials necessary for installing and servicing the unit.

Necessary tools for use with R32 (Adaptability of tools that are for use with R407C).

1. To be used exclusively with R32 ( Not to be used if used with R22 or R407C )

Tools/Materials	Use	Notes
Gauge Manifold	Evacuating,refrigerant charging	5.09MPa on the High-pressure side.
Charging Hose	Evacuating, refrigerant charging	Hose diameter larger than the conventional ones.
Refrigerant Recovery Equipment	Refrigerant recovery	
Refrigerant Cylinder	Refrigerant charging	Write down the refrigerant type. Pink in color at the top of the cylinder.
Refrigerant Cylinder Charging Port	Refrigerant charging	Hose diameter larger than the conventional ones.
Flare Nut	Connecting the unit to piping	Use Type-2 Flare nuts.

2. Tools and materials that may be used with R32 with some restrictions

Tools/Materials	Use	Notes
Gas leak detector	Detection of gas leaks	The ones for HFC type refrigerant may be used.
Vacuum Pump	Vacuum drying	May be used if a reverse flow check adaptor is attached.
Flare Tool	Flare machining of piping	Changes have been made in the flare machining dimension.Refer to the next page.
Refrigerant Recovery Equipment	Recovery of refrigerant	May be used if designed for use with R32

3. Tools and materials that are used with R410A that can also be used with R32

Tools/Materials	Use	Notes
Vacuum Pump with a Check Valve	Vacuum drying	
Bender	Bending pipes	
Torque Wrench	Tightening flare nuts	Only $\phi 12.70$ (1/2") and $\phi 15.88$ (5/8") have a larger flare machining dimension.
Pipe Cutter	Cutting pipes	
Welder and Nitrogen Cylinder	Welding pipes	
Refrigerant Charging Meter	Refrigerant charging	
Vacuum Gauze	Checking vacuum degree	

4. Tool and materials that must not used with R32

Tools/Materials	Use	Notes
Charging Cylinder	Refrigerant Charging	Must not be used with R32-type units.

Tools for R32 must be handled with special care, and keep moisture and dust from entering the cycle.



---

## R32 leakage Test

No changes from the conventional method. Note that a refrigerant leakage detector for R22 or R410A cannot detect R32 leakage.

NO

Halide torch

NO

R22 or R407C leakage detector

### Items to be strictly observed :

1. Pressurize the equipment with nitrogen up to the design pressure and then judge the equipment's air tightness, taking temperature variations into account.
2. When investigating leakage locations using a refrigerant, be sure to use R32.
3. Insure that R32 is in a liquid state when charging.

### Reasons:

1. Use of oxygen as the pressurized gas may cause an explosion.
2. Charging with R32 gas will lead the composition of the remaining refrigerant in the cylinder to change and then this refrigerant can not be used.

### Vacuuming

#### 1. Vacuum pump with check valve

A vacuum pump with a check valve is required to prevent the vacuum pump oil from flowing back into the refrigerant circuit when the vacuum pump power is turned off (power failure). It is also possible to attach a check valve to the actual vacuum pump afterwards.

#### 2. Standard degree of vacuum for the vacuum pump

Use a pump which reaches 65Pa or below after 5 minutes of operation.

In addition, be sure to use a vacuum pump that has been properly maintained and oiled using the specified oil. If the vacuum pump is not properly maintained, the degree of vacuum may be too low.

#### 3. Required accuracy of the vacuum gauge

Use a vacuum gauge that can measure up to 650Pa. Do not use a general gauge manifold since it cannot measure a vacuum of 650Pa.

#### 4. Evacuating time

Evacuate the equipment for 1 hour after 650Pa has been reached.

After envacuating, leave the equipment for 1 hour and make sure the that vacuum is not lost.

#### 5. Operating procedure when the vacuum pump is stopped

In order to prevent a backflow of the vacuum pump oil, open the relief valve on the vacuum pump side or loosen the charge hose to drawn in air before stopping operation. The same operating procedure should be used when using a vacuum pump with a check valve.

### Charging Refrigerant

R must be in a liquid state when charging.

#### Reasons:

R32 is a pseudo-azeotropic refrigerant (boiling point R32=  $-52^{\circ}\text{C}$ , R125=  $-49^{\circ}\text{C}$ ) and can roughly be handled in the same way as R410A; however, be sure to fill the refrigerant from the liquid side, for doing so from the gas side will somewhat change the composition of the refrigerant in the cylinder.

#### Note

- In the case of a cylinder with a syphon, liquid R32 is charged without turning the cylinder up side down. Check the type of cylinder before charging.

#### Remedies to be taken in case of a refrigerant leak

When refrigerant leaks, additional refrigerant may be charged. (Add the refrigerant from the liquid side)



### Characteristics of the Conventional and the New Refrigerants

- Because R32 is a simulated azeotropic refrigerant, it can be handled in almost the same manner as a refrigerant such as R410A. However, if the refrigerant is removed in the vapor phase, the composition of the refrigerant in the cylinder will somewhat change.
- Remove the refrigerant in the liquid phase. Additional refrigerant may be added in case of a refrigerant leak.

# Accessories

---

Accessories supplied with the outdoor unit:

No.	Drawing	Name of parts	Quantity
1		Drainage elbow	2
2		Rubber cushion	4
3		Clap	3

## Procedure for Selecting the Location

---

- 1) Choose a place solid enough to bear the weight and vibration of the unit, where the operation noise will not be amplified.
- 2) Choose a location where the hot air discharged from the unit or the operation noise, will not cause a nuisance to the neighbors of the user.
- 3) Avoid places near a bedroom and the like, so that the operation noise will cause no trouble.
- 4) There must be sufficient space for carrying the unit into and out of the site.
- 5) There must be sufficient space for air passage and no obstructions around the air inlet and the air outlet.
- 6) The site must be free from the possibility of flammable gas leakage in a nearby place.  
Locate the unit so that the noise and the discharged hot air will not annoy the neighbors.
- 7) Install units, power cords and inter-unit cables at least 3048mm away from television and radio sets. This is to prevent interference to images and sounds. (Noises may be heard even if they are more than 3048mm away depending on radio wave conditions.)
- 8) In coastal areas or other places with salty atmosphere of sulfate gas, corrosion may shorten the life of the air conditioner.
- 9) Since drain flows out of the outdoor unit, **do not** place under the unit anything which must be kept away from moisture.
- 10) On a flat surface that does not collect rain water.
- 11) Away from strong wind.
- 12) Away from direct exposure to rain or snow.
- 13) Away from sea breeze.
- 14) Away from inflammable materials.
- 15) Away from high temperature or open flames.

### NOTE:

- 1) Cannot be installed hanging from ceiling or stacked.
- 2) If installing on a high place such as a roof, with a fence or guard rail around it.
- 3) If there is a potential for accumulated snow to block the air inlet or heat exchanger, install the unit on a higher base.
- 4) R32 refrigerant is an unsafe, nontoxic and flammable refrigerant. However, if there is a concern about a dangerous level of refrigerant concentration in the case of refrigerant leakage, add extra ventilation.
- 5) Avoid installing the outdoor unit where corrosive gases, such as sulfur oxides, ammonia, and sulfurous gas, are produced. If unavoidable, consult with an installation specialist about using a corrosion-proof or anti-rust additive to protect the unit coils.

# Procedure for Selecting the Location

6) For seacoast applications, block the unit from direct exposure to sea breeze by installing the unit behind a structure (such as a building) or a protective wall that is 1.5 times higher than the unit, leaving 700 mm of space between the wall and unit for air circulation. Consult an installation expert about taking anti-corrosion measures, such as removing salinity on the heat exchanger and applying a rust inhibitor more frequently than once a year.

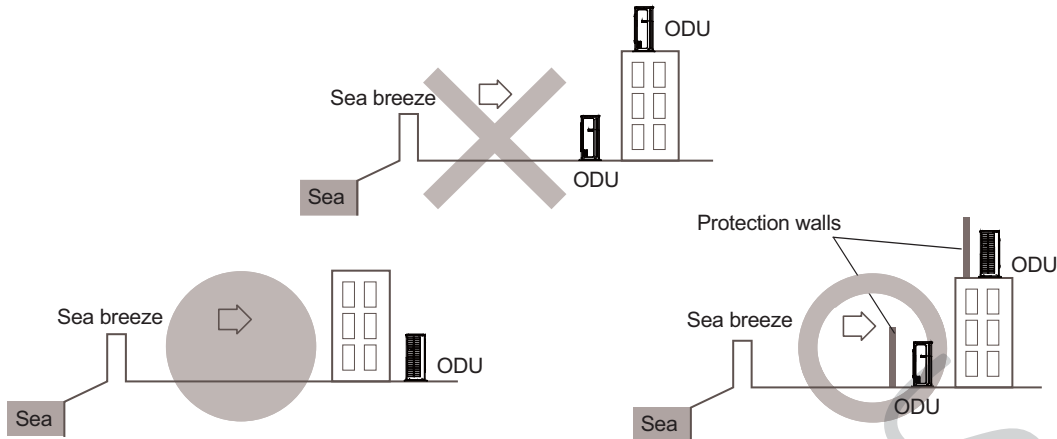

7) Set the unit on mounting brackets or pad. To avoid the adverse effects of snow, ice and defrosting issues, install the unit on heat pump risers to ensure a sufficient height from the ground. In all cases, refer to local code for correct riser height.

Make sure the outdoor unit is installed level and is stable.

Install snow protection hood as necessary.

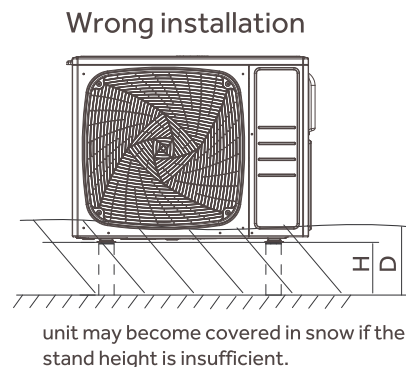
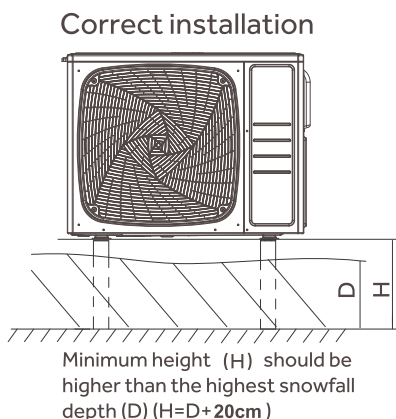
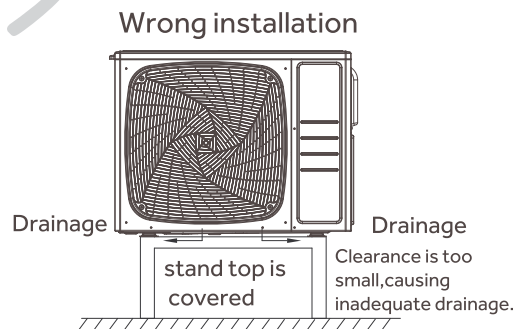
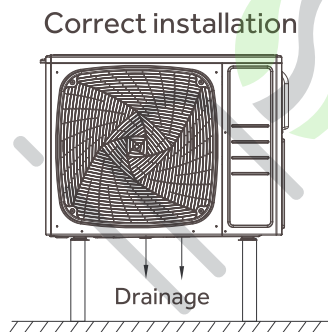

# Installation drawings of indoor and outdoor units

Do not connected the embedded branch piping and the outdoor unit when only carrying out piping work without connecting the indoor unit in order to add another indoor unit later. Make sure no dirt or moisture gets into either side of the embedded branch piping.

Installation figure please refers to the following.

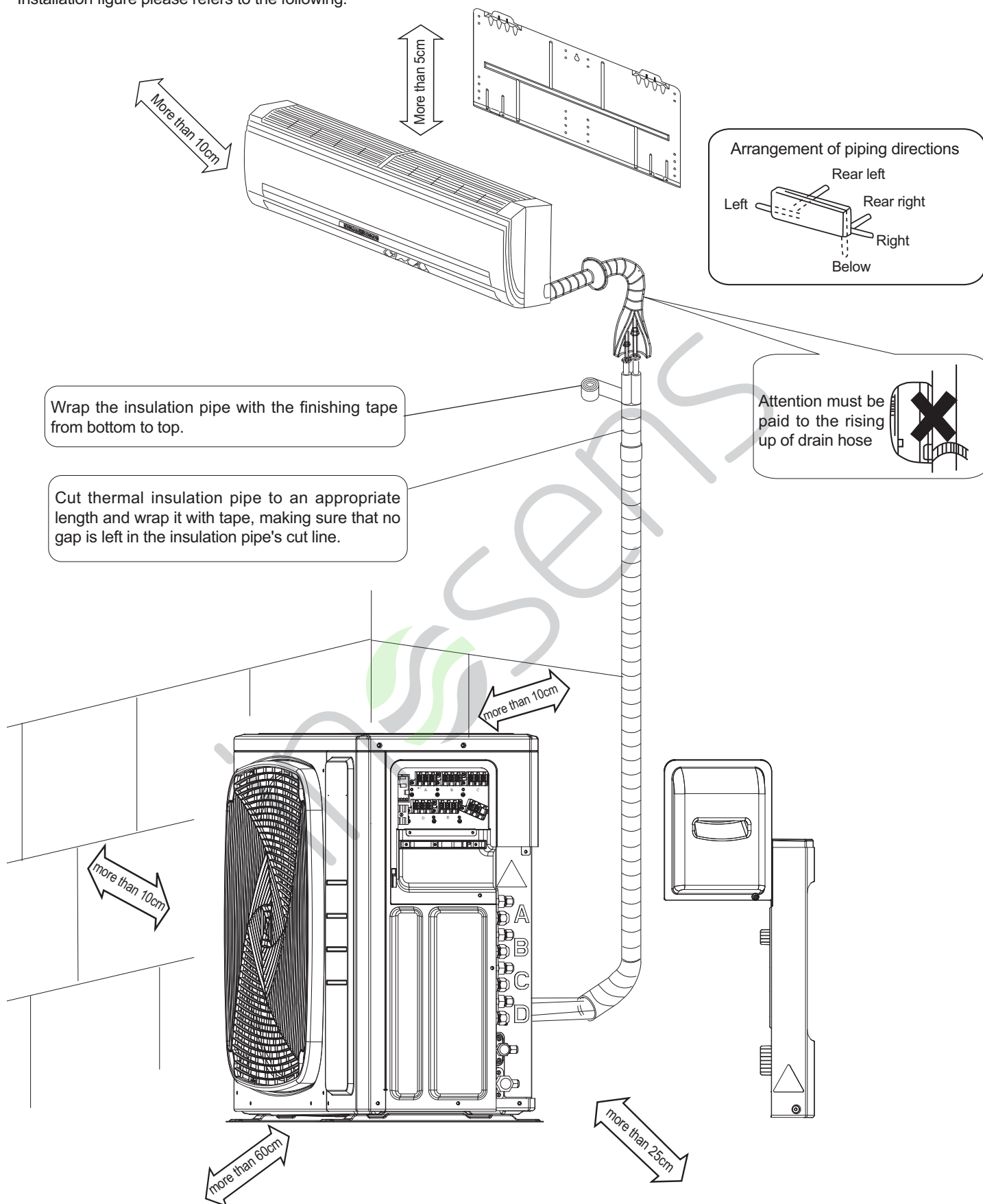

If there is the danger of the unit falling or overturning, fix the unit with foundation bolts, or with wire or other means.  
 If the location does not have good drainage, place the unit on a level mounting base (or a plastic pedestal).  
 Install the outdoor unit in a level position. Failure to do so may result in water leakage or accumulation.

# Precautions on Installation

- Check the strength and level of the installation ground so that the unit will not cause any operating vibration or noise after installed.
- In accordance with the foundation drawing in fix the unit securely by means of the foundation bolts. (Prepare four sets of M8 or M10 foundation bolts, nuts and washers each which are available on the market.)
- It is best to screw in the foundation bolts until their length are 20mm from the foundation surface.

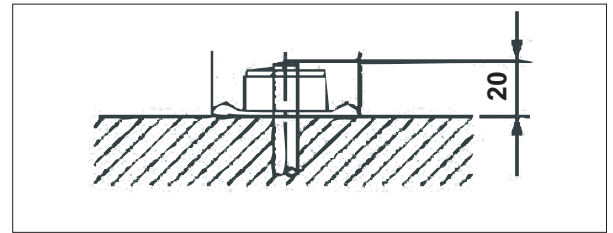

# Outdoor Unit Installation Guideline

- Where a wall or other obstacle is in the path of outdoor unit's intake or exhaust airflow, follow the installation guidelines below.
- For any of the below installation patterns, the wall height on the exhaust side should be 1200mm or less.

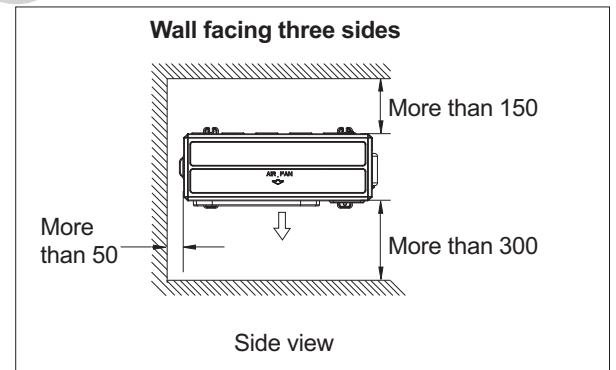
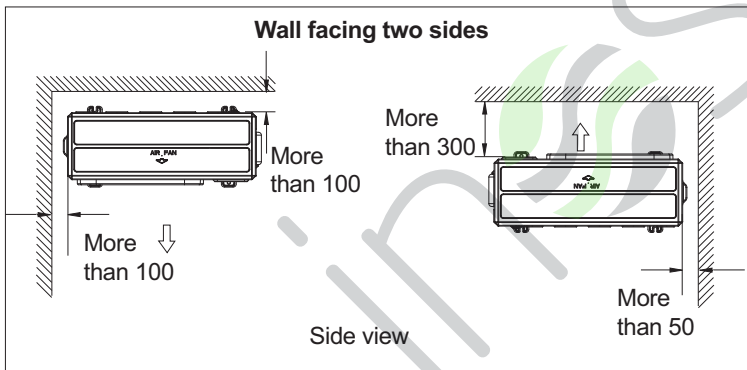
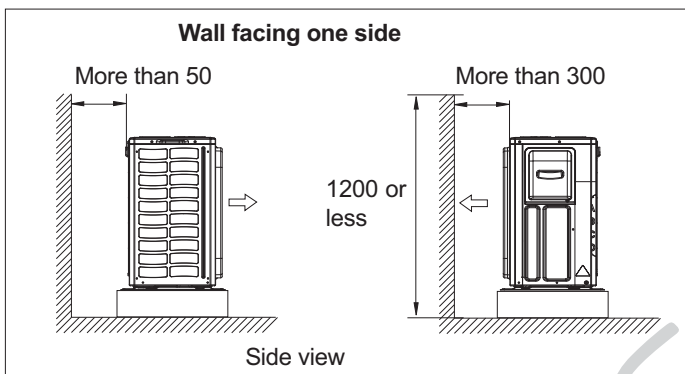

# Limitations on the installation

## 1. Precautions on installation

- Check the strength and level of the installation ground so that unit will not cause any operating vibration or noise after installation.
- In accordance with the foundation drawing in fix the unit securely by means of the foundation bolts.
- It is best to screw in the foundation bolts until their length are 20 mm from the foundation surface.

## 2. Selecting a location for installation of the indoor units

- The maximum allowable length of refrigerant piping, and the maximum allowable height difference between the outdoor and indoor units, are listed below. (The shorter the refrigerant piping, the better the performance. Connect so that the piping is as short as possible. Shortest allowable length per room is 3m)

Outdoor unit capacity class	3U55S2SR2FA	3U70S2SR2FA	4U75S2SR2FA 4U85S2SR2FA	5U105S2SS2FA
Piping to each indoor unit	25m max.	25m max.	25m max.	25m max.
Total length of piping between all units	50m max.	60m max.	70m max.	80m max.



# Limitations on the installation

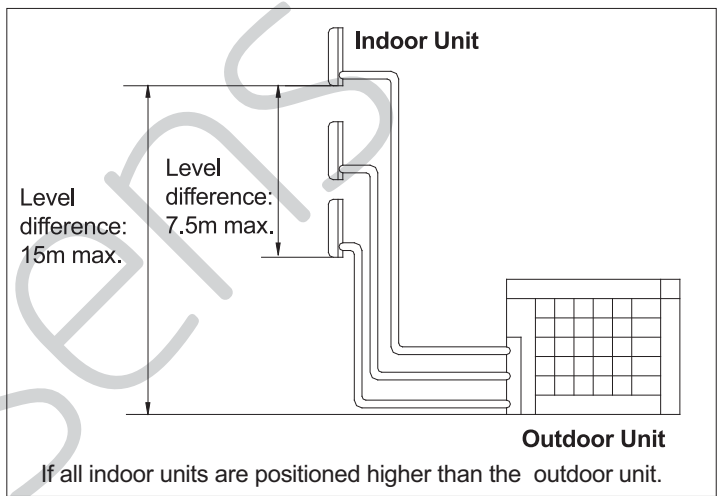
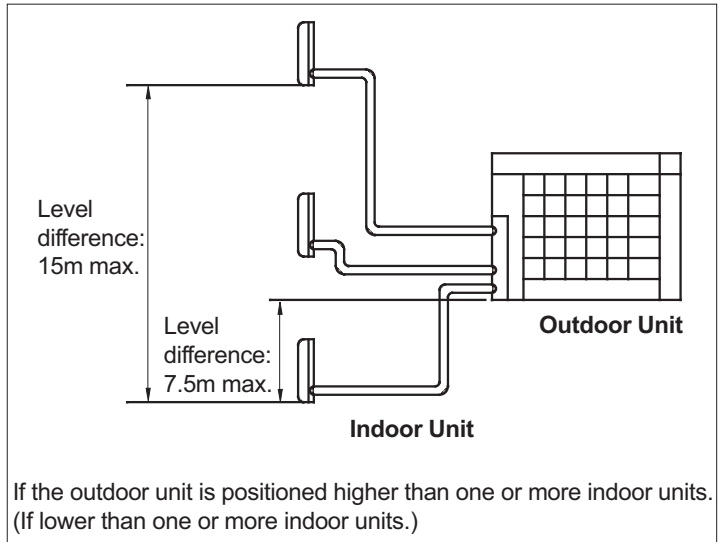
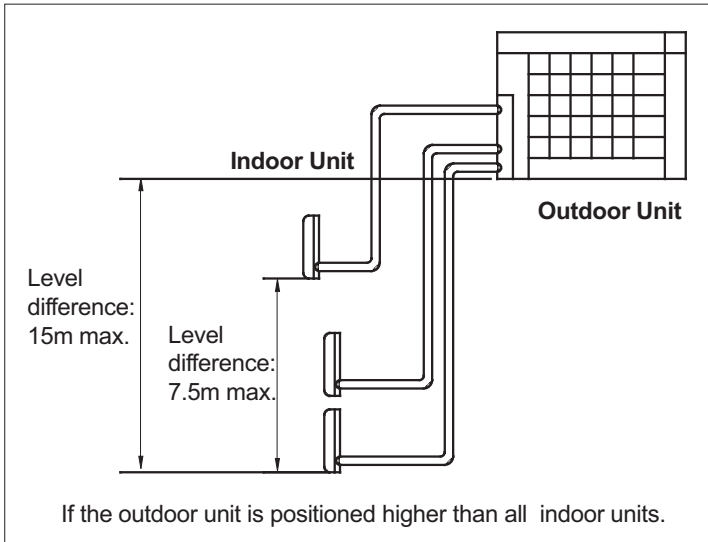

## Refrigerant piping work

### 1. Installing outdoor unit

- 1) When installing the outdoor unit, refer to "Precautions for Selecting the Location" and the "Indoor/Outdoor Unit Installation Drawings".
- 2) If drain work is necessary, follow the procedures below.

### 2. Drain work

- 1) Use drain plug for drainage.
- 2) If the drain port is covered by a mounting base or floor surface, place additional foot bases of at least 30mm in height under the outdoor unit's feet.
- 3) In cold areas, do not use a drain hose with the outdoor unit. (Otherwise, drain water may freeze, impairing heating performance.)

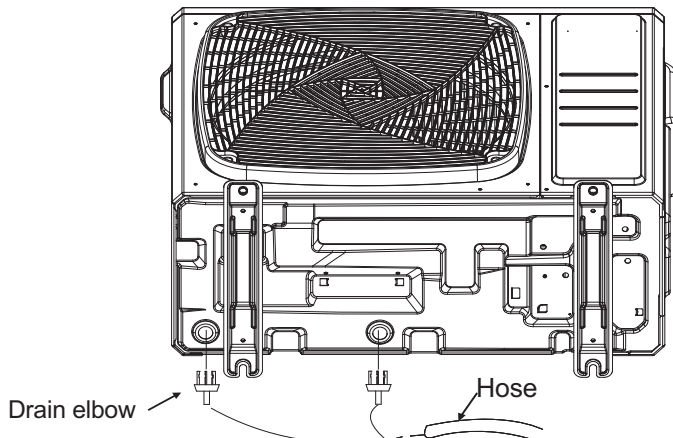

# Refrigerant piping work

## 3. Refrigerant piping work

- Align the centres of both flares and tighten the flare nuts 3 or 4 turns by hand. Then tighten them fully with the torque wrenches. Use torque wrenches when tightening the flare nuts to prevent damage to the flare nuts and escaping gas.

Flare nut tightening torque	
Flare nut for $\varnothing$ 6.35	14.2-17.2N.m(144-175kgf.cm)
Flare nut for $\varnothing$ 9.52	32.7-39.9N.m(333-407kgf.cm)
Flare nut for $\varnothing$ 12.7	49.5-60.3N.m(505-615kgf.cm)
Flare nut for $\varnothing$ 15.88	61.8-75.4N.m(630-769kgf.cm)

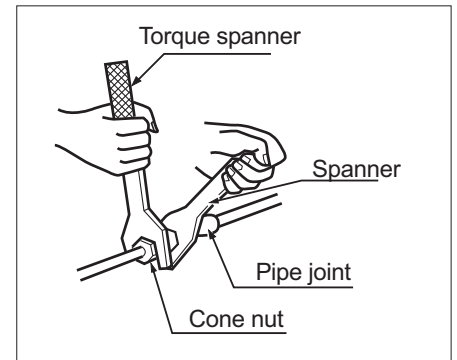
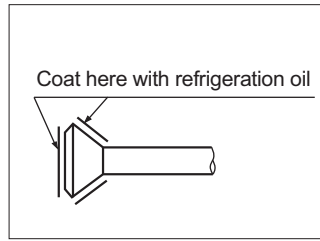

Valve cap tightening torque	
Liquid pipe	26.5-32.3N.m(270-330kgf.cm)
Gas pipe	48.1-59.7N.m(490-610kgf.cm)

Service port cap tightening torque	
10.8-14.7N.m(110-150kgf.cm)	

- To prevent gas leakage, apply refrigeration oil on both inner and outer surfaces of the flare. (Use refrigeration oil for R32)

## 4. Purging air and checking gas leakage

When piping work is completed, it is necessary to purge the air and check for gas leakage.

### WARNING

- Do not mix any substance other than the specified refrigerant (R32) into the refrigeration cycle.
- When refrigerant gas leaks occur, ventilate the room as soon and as much as possible.
- R32, as well as other refrigerants, should always be recovered and never be released directly into the environment.
- Use a vacuum pump for R32 exclusively. Using the same vacuum pump for different refrigerants may damage the vacuum pump or the unit.

- If using additional refrigerant, perform air purging from the refrigerant pipes and indoor unit using a vacuum pump, then charge additional refrigerant.
- Use a hexagonal wrench (4mm) to operate the stop valve rod.
- All refrigerant pipe joints should be tightened with a torque wrench at the specified tightening torque.

Connect projection side of charging hose(Which comes from gauge manifold) to gas stop valve's service port.



Fully open gauge manifold's low-pressure valve(Lo) and completely close its high-pressure valve(Hi).  
(High-pressure valve subsequently requires no operation.)



Apply vacuum pumping. Check that the compound pressure gauge reads-0.1MPa(-76cmHg).  
Evacuation for at least 1 hour is recommended.



Close gauge manifold's low-pressure valve(Lo) and stop vacuum pump.  
(Leave as is for 4-5 minutes and make sure the coupling meter needle does not go back.  
If it does go back, this may indicate the presence of moisture or leaking from connecting parts. After inspecting all the connection and loosening then retightening thenuts, repeat steps 2-4. )



Remove covers from liquid stop valve and gas stop valve.



Turn the liquid stop valve's rod 90 degrees counterclockwise with a hexagonal wrench to open valve.  
Close it after 5 seconds, and check for gas leakage.  
Using soapy water, check for gas leakage from indoor unit's flare and outdoor unit's flare and valve rods.  
After the check is complete, wipe all soapy water off.



Disconnect charging hose from gas stop valve's service port, then fully open liquid and gas stop valves.  
(Do not attempt to turn valve rod beyond its stop.)



Tighten valve caps and service port caps for the liquid and gas stop valves with a torque wrench at the specified torques. See "3 Refrigerant piping " on page 23 for details.

## 5. Refilling the refrigerant

Check the type of refrigerant to be used on the machine nameplate.

### Precautions when adding R32

#### Fill from the liquid pipe in liquid form.(recommend)

1) Before filling, check whether the cylinder has a siphon attached or not.(It should have something like "liquid filling siphon attached" displayed on it.) (recommend)

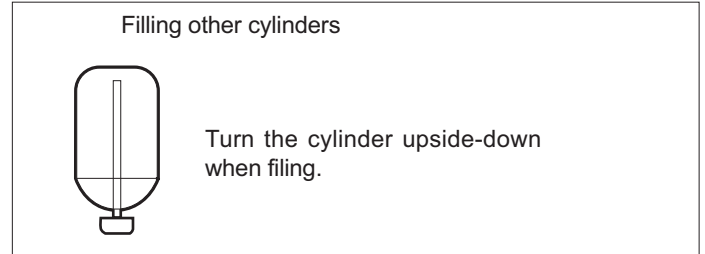
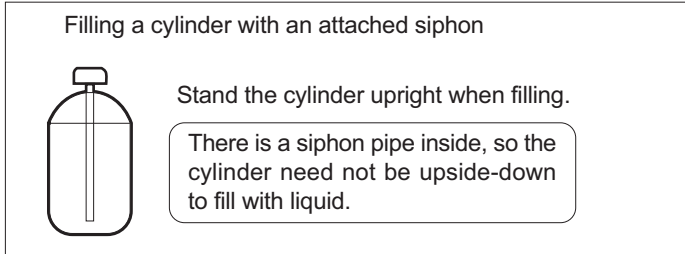

2) Be sure to use the R32 tools to ensure pressure and to prevent foreign objects entering.

## 6. Charging with refrigerant

- 1) This system must use [refrigerant R32](#).
- 2) Add refrigerant 20g per meter when the total piping length exceeds the standard value, but make sure that the total liquid piping length should be less than the max. value.

Outdoor Unit	Standard total liquid piping length	Max. total liquid piping length
3U55S2SR2FA	30m	50m
3U70S2SR2FA	30m	60m
4U75S2SR2FA 4U85S2SR2FA	40m	70m
5U105S2SS2FA	40m	80m

## 7. Precautions for Laying Refrigerant Piping

### • Cautions on pipe handling

- 1) Protect the open end of the pipe against dust and moisture.
- 2) All pipe bends should be as gentle as possible. Use a pipe bender for bending.(Bending radius should be 30 to 40mm or larger.)

### • Selection of copper and heat insulation materials

When using commercial copper pipes and fittings, observe the following :

- 1) Insulation material: Polyethylene foam  
Heat transfer rate: 0.041 to 0.052W/mK(0.035to 0.045kcal/mh°C)  
Refrigerant gas pipe's surface temperature reaches 110°C max.  
Choose heat insulation materials that will withstand this temperature.
- 2) Be sure to insulate both the gas and liquid piping and to provide insulation dimensions as below.

Gas pipe	Gas pipe insulation
O.D.:9.52mm,12.7mm Thickness:0.8mm	I.D.:12-15mm,12.7mm Thickness:13mm min.
Liquid pipe	Liquid pipe insulation
O.D.:6.35mm Thickness:0.8mm	I.D.:18-10mm Thickness:10mm min.

3) Use separate thermal insulation pipes for gas and liquid refrigerant pipe.

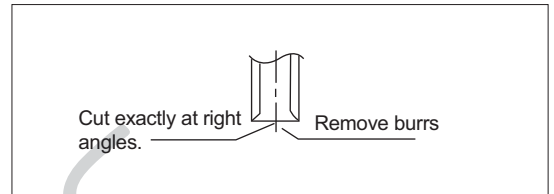
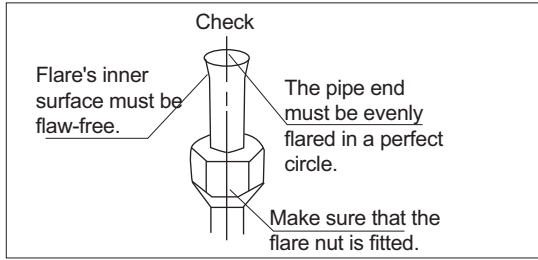
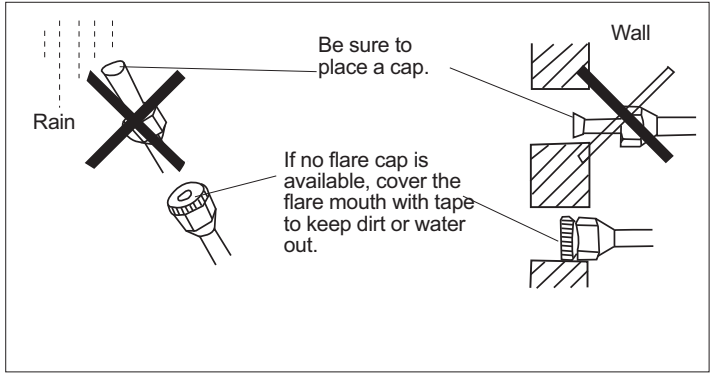
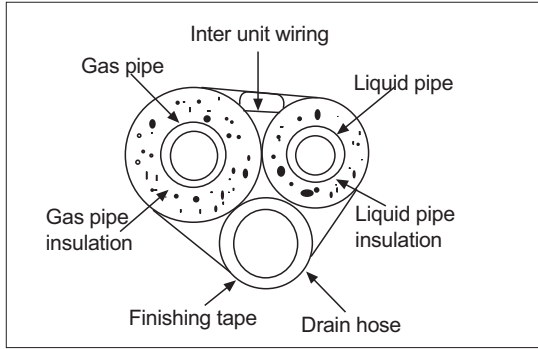

Set exactly at the position shown below.

 Flare tooling die	Flare tool for R32	Conventional flare tool	
	Clutch-type	Clutch-type(Rigid-type)	Wing-nuttype(Imperial-type)
	0-0.5mm	1.0-1.5mm	1.5-2.0mm

### 8. Cutting and Flaring work of piping

- Pipe cutting is carried out with a pipe cutter and burrs must be removed.
- After inserting the flare nut, flaring work is carried out.

 Flare tooling die	Pipe	Pipe diameter $\phi$	Size A (mm)
	Liquid side	6.35mm(1/4")	0.8~1.5
	Gas side	9.52mm(3/8")	1.0~1.5
		12.7mm(1/2")	1.0~1.5

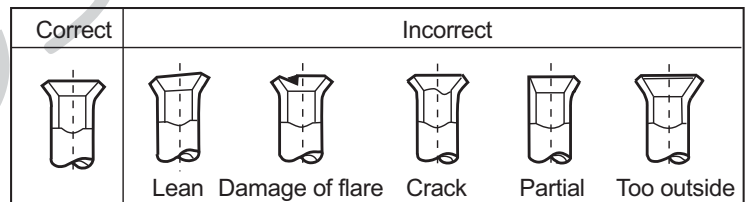

### 9. On drainage

- Please install the drain hose so as to be downward slope without fail. Please don't do the drainage as shown below.

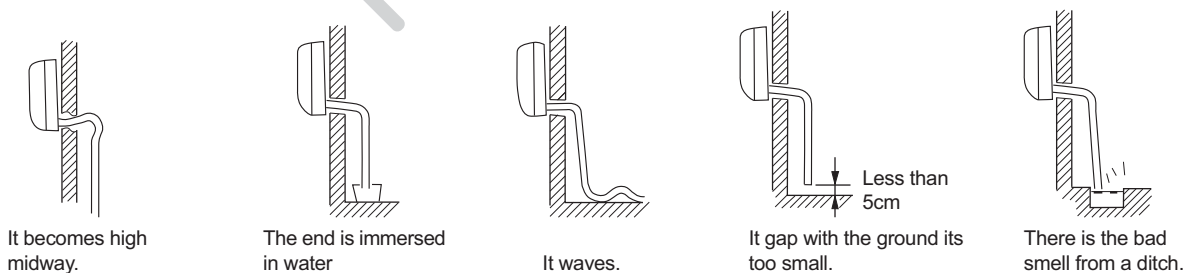

- Please pour water in the drain pan of the indoor unit, and confirm that drainage is carried out thoroughly to outdoor.
- In case that the attached drain hose is in a room, please apply heat insulation to it without fail.

### ⚠ WARNING

- 1) Do not use mineral oil on flared part.
- 2) Prevent mineral oil from getting into the system as this would educe the lifetime of the units.
- 3) Never use piping which has been used for previous installations. Only use parts which are delivered with the unit.
- 4) Do never install a drier to this R32 unit in order to guarantee its lifetime. The drying material may dissolve and damage the system.
- 5) Incomplete flaring may cause refrigerant gas leakage.

# Pump Down Operation

In order to protect the environment, be sure to pump down when relocating or disposing of the unit.

- 1) Remove the valve caps from liquid stop valve and gas stop valve.
- 2) Carry out forced cooling operation.
- 3) After five to ten minutes, close the liquid stop valve with a hexagonal wrench.
- 4) After two to three minutes, close the gas stop valve and stop forced cooling operation.

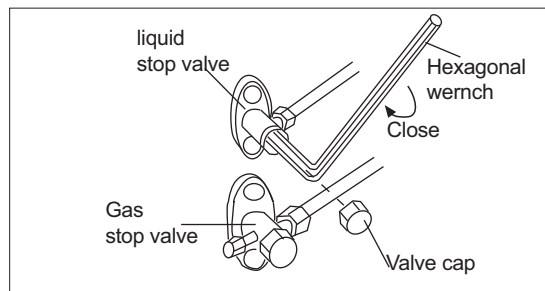

## Wiring work

### 1. Electric wiring

- The air conditioner must use special circuit, and wiring by the qualified electrician according to the wiring rules specified in national standard.
- The grounding wire and the neutral wire shall be strictly separated. Connect the neutral wire with grounding wire is incorrect.
- The explosion-proof electric leakage breaker must be installed.
- All the electric wire must be copper wire. Power supply: 1PH, 220-240V~, 50/60Hz.
- The wiring method of power line is Y connection. If the power line is damaged, in order to avoid risk of electric shock, it must be replaced by the manufacturer or its repair center or other similar qualified person. The connecting cable must be shielded.  
Fuse: T25A 250VAC (Power circuit board).
- Please check the circuit diagram about the fuse replaced, explosion-proof fuse.
- The specification of power cable is H05RN-F3G 4.0mm<sup>2</sup>.
- The specification of cable between indoor unit to outdoor unit is H05RN-F4G 2.5mm<sup>2</sup>.

### 2. Wiring method

- Wiring method of orbicular terminals  
For the connection wire with orbicular terminals, its wiring method is as shown in the right figure: remove the connecting screw, put the screw through the ring on the end of the wire, then connect to the terminal block and fasten screw.
- Wiring method of straight terminals.  
For the connection wire without orbicular terminals, its wiring method is: loosen the connection screw, and insert the end of the connection wire completely into the Terminal block, then fasten the screw.  
Slightly pull the wire outwards to confirm it is firmly held.

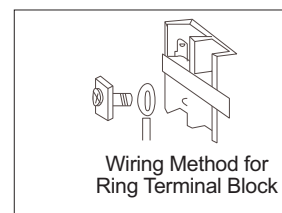

- Crimp connection method for wires without terminals

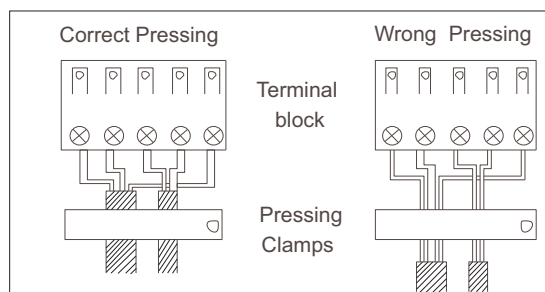
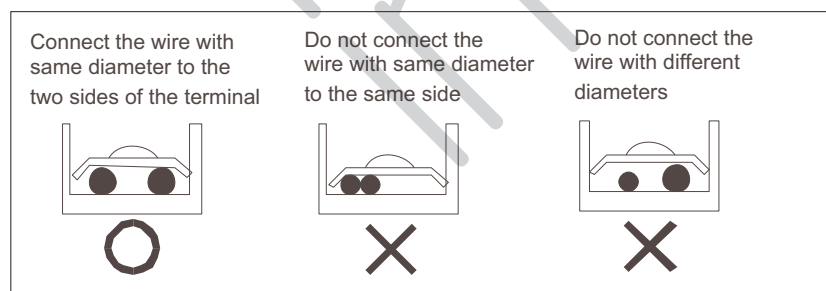

- Crimp connection method for connection wire  
After connection, the wire must be fastened by wire cover. The wire cover shall press on the protection coat of the connection wire, as shown in right top figure.  
Note: When connecting the wiring, confirm the terminal number of indoor and outdoor units carefully. Incorrect wiring will damage the controller of air conditioner or the unit can not operate.

### 3. Wiring method of outdoor unit:

- Power cord  
Remove the Valve cover of the outdoor unit and loosen the wire cover A, then put the live wire, neutral wire and grounding wire through the wire cover, and connect them to terminal block correspondingly. After connection, fasten wire cover to its previous state.  
Communication wire of indoor unit.
- Loosen wire cover, put the communication wire through the wire cover B, and connect them to terminal block correspondingly. After connection, fasten wire cover B to its previous state.

**Note: Power cord and communication wire are provided by consumers themselves.**



# Wiring work

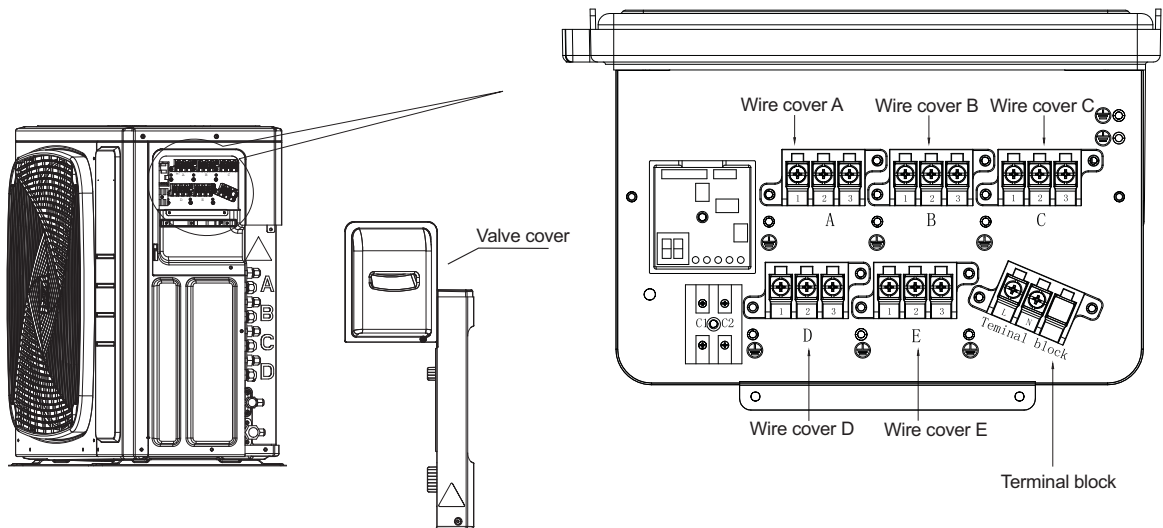

## 4. Wiring method of indoor unit

Loosen wire cover and connect the power cord and communication wire of indoor unit to the terminal correspondingly.

### Note:

**When connecting power cord to power supply terminal, please pay attention to the following items:**

- Do not connect the power cord with different dimensions to the same connection wire end. Improper contact will cause heat generation.
- Do not connect the power line with different dimensions to the same grounding wire end. Improper contact will affect protection.
- Do not connect the power line to the connecting end of communication wire. Incorrect connection will cause damage to the connected unit.
- The wiring should ensure that the ground line is the last one to be broken off by force.

## 5. Example wiring diagram.

Wiring diagram please refers to the following.

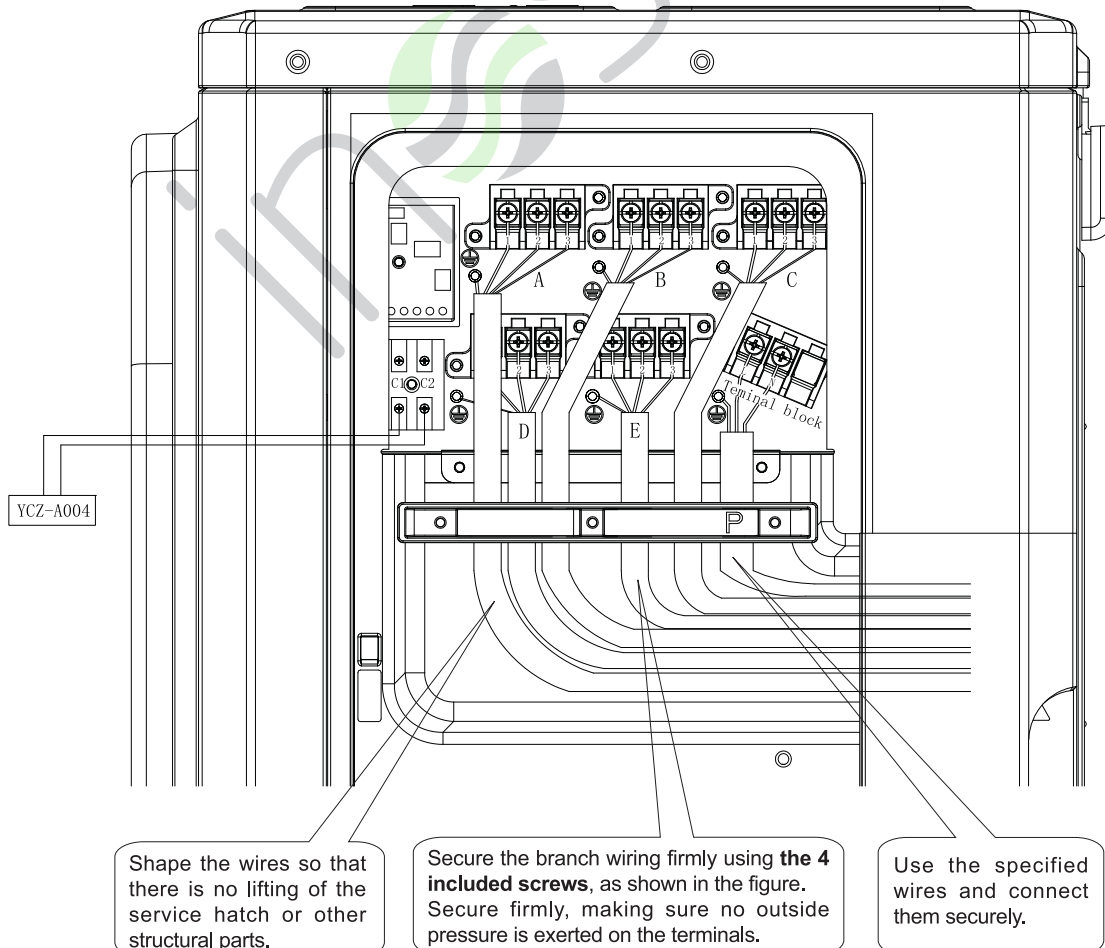

# Test running

- Before starting the test running, please confirm the following works have been done successfully.
  - 1) Correct piping work;
  - 2) Correct wiring work;
  - 3) Correct match of indoor and outdoor unit;
  - 4) Proper recharge of refrigerant if needed.
- Make sure that all the stop valves are fully open.
- Check the voltage supplied to the outdoor and indoor units, please confirm that is 220-240V.
- Wiring Error Check

This product is capable of automatic checking of wiring error.

Switch on all the 4 dip-switches on the outdoor unit small service PC-board as shown on the right. Then power off the unit and power on again, the system will enter the operation of "Wiring Error Check". After 3 minutes stand-by, the unit starts for automatic wiring checking. Approximately 30 ~ 50minutes (depends on how many units installed in the system) after the unit starts, the Errors of the wiring will be shown by the LEDs (1 to 3).

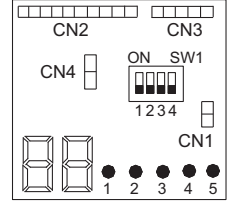

During this operation, the digital-number will alternately show the compressor working frequency (e.g. 50 stands for the current running frequency) and letter "CH"(means checking).

After this operation, if all the wiring is correct, the digital-number will show "0", if there has wrong wiring, the digital-number will show "EC"(error connection) and also it will flashing.

The service monitor LEDs indicate the error of wiring, as shown in the table below. For details about how to read the LED display, refer to the service manual.

If self-checking is not possible, check the indoor unit wiring and piping in the usual manner.

LED	1	2	3	4	5	Message
Status	OFF					Unit not connected
	ALL Flashing					Automatic checking impossible, all units connect wrong
	ALL ON					All units connect correctly
	ON	FLASHING	FLASHING	ON	FLASHING	<b>ON:</b> unit connect correctly <b>FLASHING:</b> unit connect wrong, need to change the wiring manually between 2,3,and 5
	ON	FLASHING	FLASHING	ON	ON	<b>ON:</b> unit connect correctly <b>FLASHING:</b> unit connect wrong, need to change the wiring manually between 2,3
	Only one LED flashing					Abnormal

- Test running.
  - 1) To test cooling, set the lowest temperature at 16 °C. To test heating, set the highest temperature, at 30 °C. If the temperature is lower than 16 °C, it is impossible to test cooling with remote controller, and also when the temperature is higher than 30 °C, it is impossible to test heating.
  - 2) Please check both cooling and heating operation of each unit individually and then also check the simultaneous operation of all indoor units.
  - 3) After running the unit for about 20 minutes, check the indoor unit outlet temperature.
  - 4) After the unit is stopped, or working mode changed, the system will not start again for about 3 minutes.
  - 5) During cooling operation, frost may occur on the indoor unit or pipes, this is normal.
  - 6) Operate the unit according to the operation manual. Please kindly explain to our customers how to operate through the instruction manual.

- Seven-segment numeric display

1) When unit is running, this seven-segment numeric will display the frequency of compressor. For example, "40" means compressor running frequency is 40 Hz, "108" means compressor running frequency is 108Hz.

2) When faulty happens, seven-segment numeric will flash and display some numbers, this number is failure code. For example, a flashing "15" means No.15 failure, that is indoor and outdoor communication error.

- Communication LED

3U55S2SR2FA and 3U70S2SR2FA are with 3 green LED that means 3 indoor units, 4U75S2SR2FA and 4U85S2SR2FA with 4 green LED means 4 indoor units. 5U105S2SS2FA with 5 green LED means 5 indoor units. If one LED keep lighting that means the corresponding indoor unit has good communication with outdoor unit. If one LED is not lighting, that means there is no communication between indoor and outdoor.

- Notes:

- 1) When using this product, you need not to set the address. But the L/N wires between indoor & outdoor units must be corresponded, or there will be communication failure.
- 2) Quiet Operation Setting. Set the DIP "8" to ON position of SW5, the system will run with lower noise, but the max. capacity will also reduce slightly.
- 3) Do not change the settings of other switches, wrong settings can make the system damage or other malfunctions.

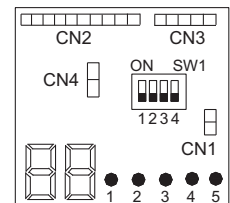

# Trouble shooting

Possible reasons	Outdoor LED display	Wired controller display	Cassette and convertible indoor display outdoor error code use the timer and running lamp	
			Timer lamp flash time	Running lamp flash time
Faulty of outdoor unit EEPROM	1	15	2	1
IPM overcurrent or short circuit	2	16	2	2
Communication failure between Module and ECU	4	18	2	4
Module operated overload	5	19	2	5
Module low or high voltage	6	1A	2	6
Discharging temperature overheating.Lack of refrigerant, ambient temperature too high or PMVs blocked.	8	1C	2	8
Malfunction of the DC fan motor	9	1D	2	9
Malfunction of defrosting temp. sensor	10	1E	3	0
Malfunction of compressor suction temp. sensor	11	1F	3	1
Malfunction of ambient temp. sensor	12	20	3	2
Malfunction of compressor discharge temp. sensor	13	21	3	3
Communication failure between indoor&outdoor unit	15	23	3	5
Lack of refrigerant or discharging pipe blocked	16	36	3	6
4-way valve switching failure	17	25	3	7
Loss of synchronism detection	18	26	3	8
Indoor thermal overload	20	28	4	0
Indoor frosted	21	29	4	1
Module thermal overload	23	2B	4	3
Compressor start failure	24	2C	4	4
Module input overcurrent	25	2D	4	5
MCU reset	26	2E	4	6
Module input current detect circuit malfunction	27	2F	4	7
Malfunction of liquid pipe temp. sensor for indoor unit A	28	30	4	8
Malfunction of liquid pipe temp. sensor for indoor unit B	29	31	4	9
Malfunction of liquid pipe temp. sensor for indoor unit C	30	32	5	0
Malfunction of liquid pipe temp. sensor for indoor unit D	31	33	5	1
Malfunction of gas pipe temp. sensor for indoor unit A	32	34	5	2
Malfunction of gas pipe temp. sensor for indoor unit B	33	35	5	3
Malfunction of gas pipe temp. sensor for indoor unit C	34	36	5	4
Malfunction of gas pipe temp. sensor for indoor unit D	35	37	5	5
Malfunction of gas pipe temp. sensor for indoor unit E	36	38	5	6
Malfunction of module temp.sensor Momentary power failure detection	38	3A	5	8
Malfunction of condensing temp. sensor	39	3B	5	9
Malfunction of liquid pipe temp. sensor for indoor unit E	40	3C	6	0
System high pressure switch off	42	3E	6	2
System low pressure switch off	43	3F	6	3
System high pressure protection.Refrigerant overabundance,High condensing temp. or malfunction of fan motor.	44	40	6	4
System low pressure protection.Refrigerant shortage, Low defrosting temp., or malfunction of fan motor.	45	41	6	5

inSens



**Haier**

Address: Haier Industrial Park, Qianwangang Road, Eco-Tech Development Zone, Qingdao 266555, Shandong, P.R.C.

Contacts: TEL +86-532-88936943; FAX +86-532-8893-6999

Website: [www.haier.com](http://www.haier.com)